

Project: IEEE P802.15 Working Group for Wireless Personal Area Networks (WPANs)

Submission Title: [Overview of Activity of IEEE802.15 TG15.6ma for Revision of IEEE802.15.6-2012 Wireless BAN with Enhanced Dependability]

Date Submitted: [January 13th 2025]

Source: [Ryuji Kohno] [1;Yokohama National University(YNU), 2;YRP International Alliance Institute(YRP-IAI)]

Address [1; 79-5 Tokiwadai, Hodogaya-ku, Yokohama, Japan 240-8501

2; YRP1 Bldg., 3-4 HikarinoOka, Yokosuka-City, Kanagawa, Japan 239-0847]

Voice:[1; +81-90-5408-0611], FAX: [+81-45-383-5528],

Email:[1: kohno@ynu.ac.jp, 2:kohno@yrp-iai.jp]

Abstract: [This document summarizes standardization activity of IEEE802.15 Task Group(TG)6ma for revision of IEEE802.15.6 - 2012 Medical Body Area Network(BAN) corresponding to increasing for enhanced dependability in wireless sensing and controlling human and vehicle bodies for medical healthcare and automotive uses. After quick overview of IEEE802.15.6 -2012, necessity of the revision is described in such critical use cases that various types of interference such as intra BAN interference in multiple overlaid BANs, interference among BAN and other networks in some overlaid frequency band etc. Extension of BAN from human body for medical healthcare to car body for automotive uses and their combination makes a larger market and a new application in medical and automotive industries with a common standard.]

Purpose: [information]

Notice: This document has been prepared to assist the IEEE P802.15. It is offered as a basis for discussion and is not binding on the contributing individual(s) or organization(s). The material in this document is subject to change in form and content after further study. The contributor(s) reserve(s) the right to add, amend or withdraw material contained herein.

Release: The contributor acknowledges and accepts that this contribution becomes the property of IEEE and may be made publicly available by P802.15.

Overview of Activity of IEEE802.15 TG15.6ma for Revision of IEEE802.15.6-2012 Wireless BAN with Enhanced Dependability

Ryuji Kohno,
Yokohama National University, Japan(YNU)
YRP International Alliance Institute, Japan(YRP-IAI)

Agenda

1. Demand for WBAN for Emergent Medical Healthcare Use and Huge Market of Automotive Use and Expecting New Use Cases
2. Short Review of WBAN Standard IEEE802.15.6-2012
3. Necessity and Uniqueness for Revision of BAN with Enhanced Dependability
4. Channel and Environment Models for Focused Use Cases in Human and Vehicle BANs with Enhanced Dependability
5. Requirement for Revision of 15.6 MAC for Human and Vehicle BANs with Enhanced Dependability TG16.6ma
6. Core Technologies in PHY Layer for Enhanced Dependability TG16.6ma
7. Core Technologies in MAC Layer for Enhanced Dependability TG16.6ma
8. Time Sensitive Network(TSN)
9. Letter Ballot210 and Timeline of TG6ma

1. Demand for WBAN for Emergent Medical Healthcare Use and Huge Market of Automotive Use

1.1 Demand of BAN for Medical Uses

A. Emergent Problems over the world:

- 1-4% of total population in a world may be suffered by COVID-19, that is a global pandemic.
- Clinic are overloaded and many business are damaged seriously.

COVID-19 Pandemic



Population Ageing

B. Challenging but Feasible Solutions:

- ◆ Provide Remote Vital Sensing and Therapy Using ICT and AI
 - Prevent Epidemic and Maintain Safe and Efficient Diagnosis
- ◆ Promote Global Business of Medical ICT and Data Science



C. Approach:

- (1) R&D of Enable Technologies for Pandemic and Daily QoL
- (2) Promote International Standard of **Wireless Body Network(BAN) and Integrated Platform of BAN/5G/AI** for Global Marketing
- (3)Regulatory Compliance of Medical Devices & Services to Ensure Safety, Reliability, Security, i.e. Dependability by **Regulatory Science**

1.2 Medical Inspection and Treatment by BAN

- Medical Healthcare Using BAN can perform remote real-time medical diagnosis and therapy
- To prevent pandemic against **COVID-19** and medical care incident etc. in daily life.
- > Remote sensing vital sign and monitoring symptoms
- > Evidence based medicine for clinical and nursing actions
- •To support safe and efficient medical care for clinical staffs and patients etc.
- > Online diagnosis, PCR and other inspection
- > Protect clinical staffs and care givers with network

• **WBAN can apply for preventing pandemic and supporting daily care by remote sensing and therapy in digital healthcare.**

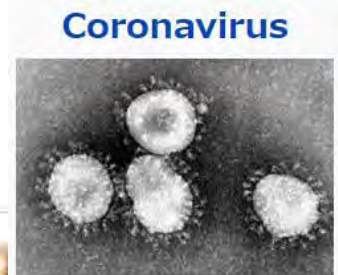

Server on Medical S

Common symptoms:	
Fever:	83-99%
Loss of Appetite:	40-84%
Fatigue:	44-70%
Loss of smell:	15 to 30%
Shortness of breath:	31-40%
Cough:	59-82%
Coughing up sputum:	28-33%
Muscle aches	

Symptoms of COVID-19

1.3 Wireless BAN: Body Area Network

Wearable BAN

Tele-metering or sensing vital signs with various sensors

- ECG
- EEG
- SPO2
- Blood Pressure
- Heartbeat
- Body temperature
- Glucose level
- Medical images(X-ray, MRI) and video

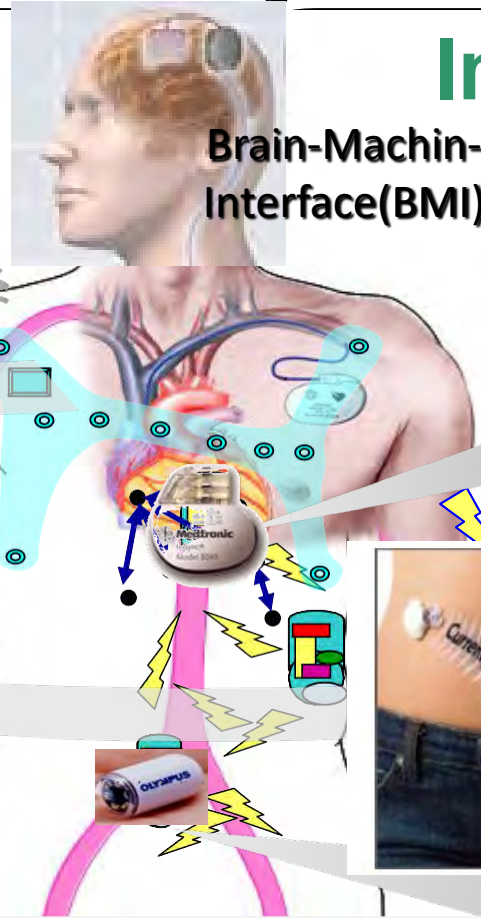

Brain-Machin-Interface(BMI)

Implant BAN

Tele-control of Medical Equipment and Devices

Pace Maker with ICD



Wireless Capsule Endoscope

Novel Concept Intelligent Network of Vital Sensors, eHR, Medical Robots etc.

1.4 BAN- Use Cases for Remote Medical Services

Medical support for developing countries

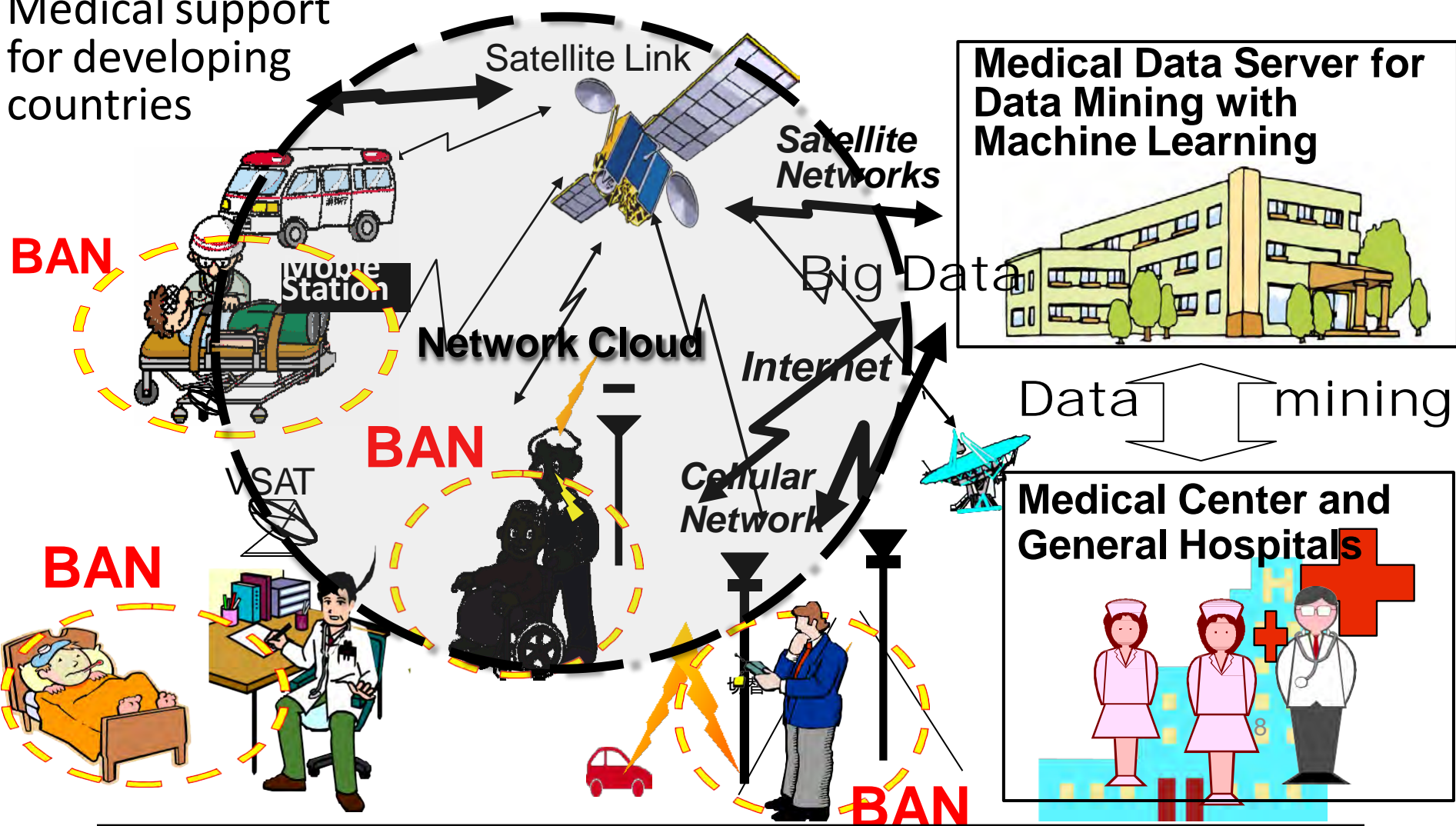

BAN

BAN

BAN

BAN

1.5 BAN-base Universal Platform with Network Cloud, Data Mining Server for Medical Healthcare

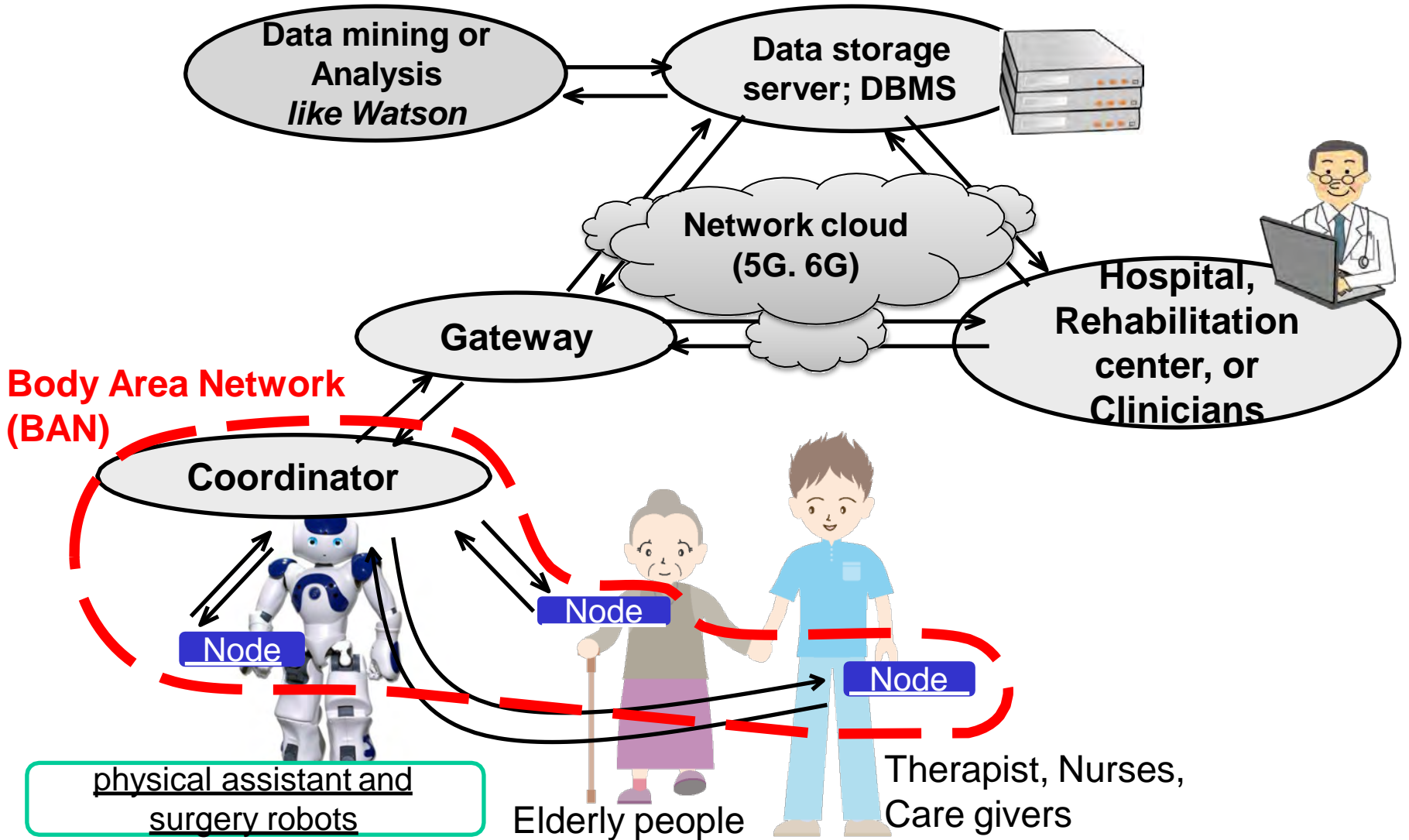

Integrated Platform among Wireless BAN, 5G/6G Cloud Network and AI Data Servers

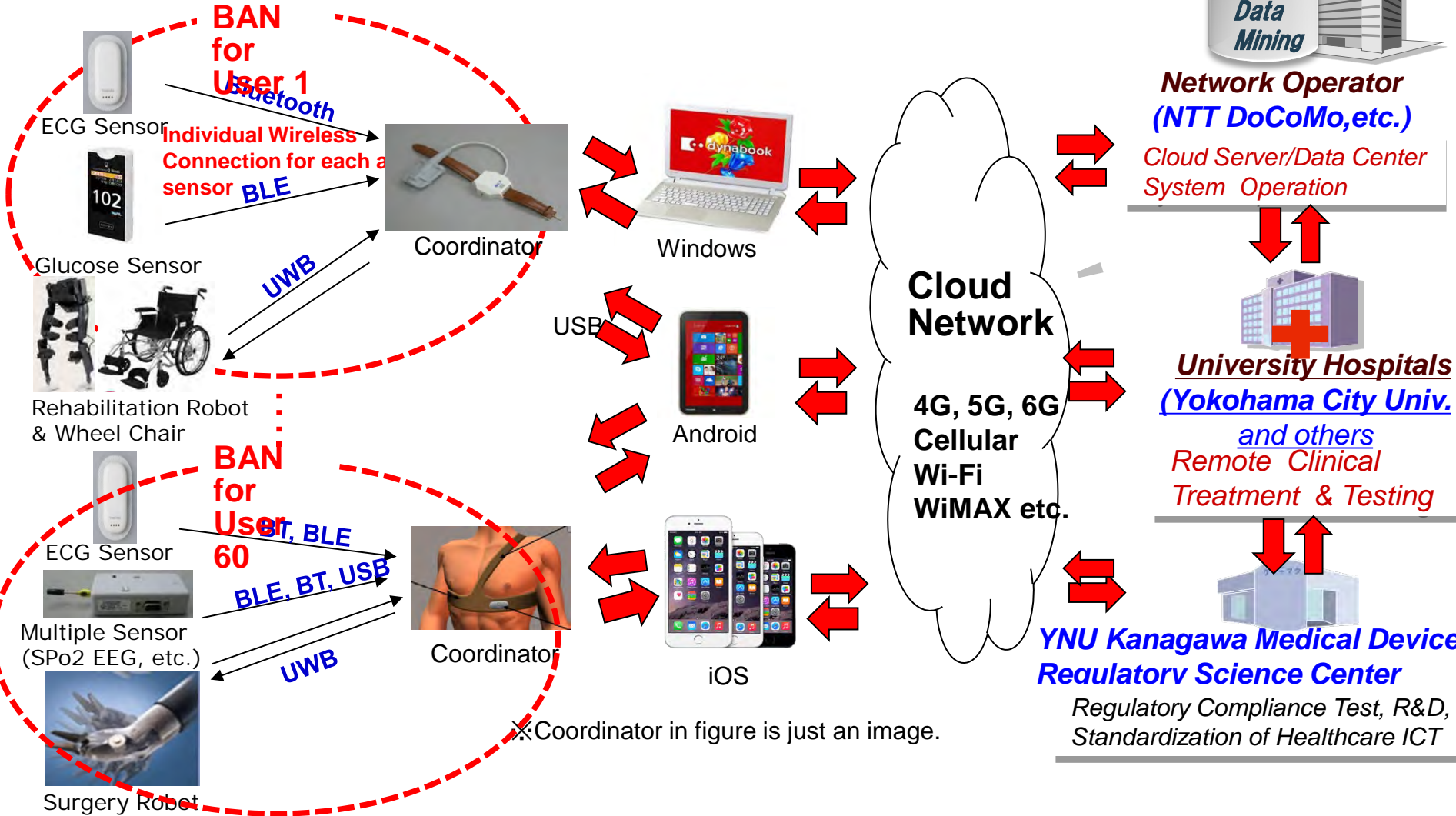

*Coordinator in figure is just an image.

1.6 Universal Platform Based on BAN, Cloud Network, and AI Data Server for General Social Infrastructure in Medical Healthcare Services

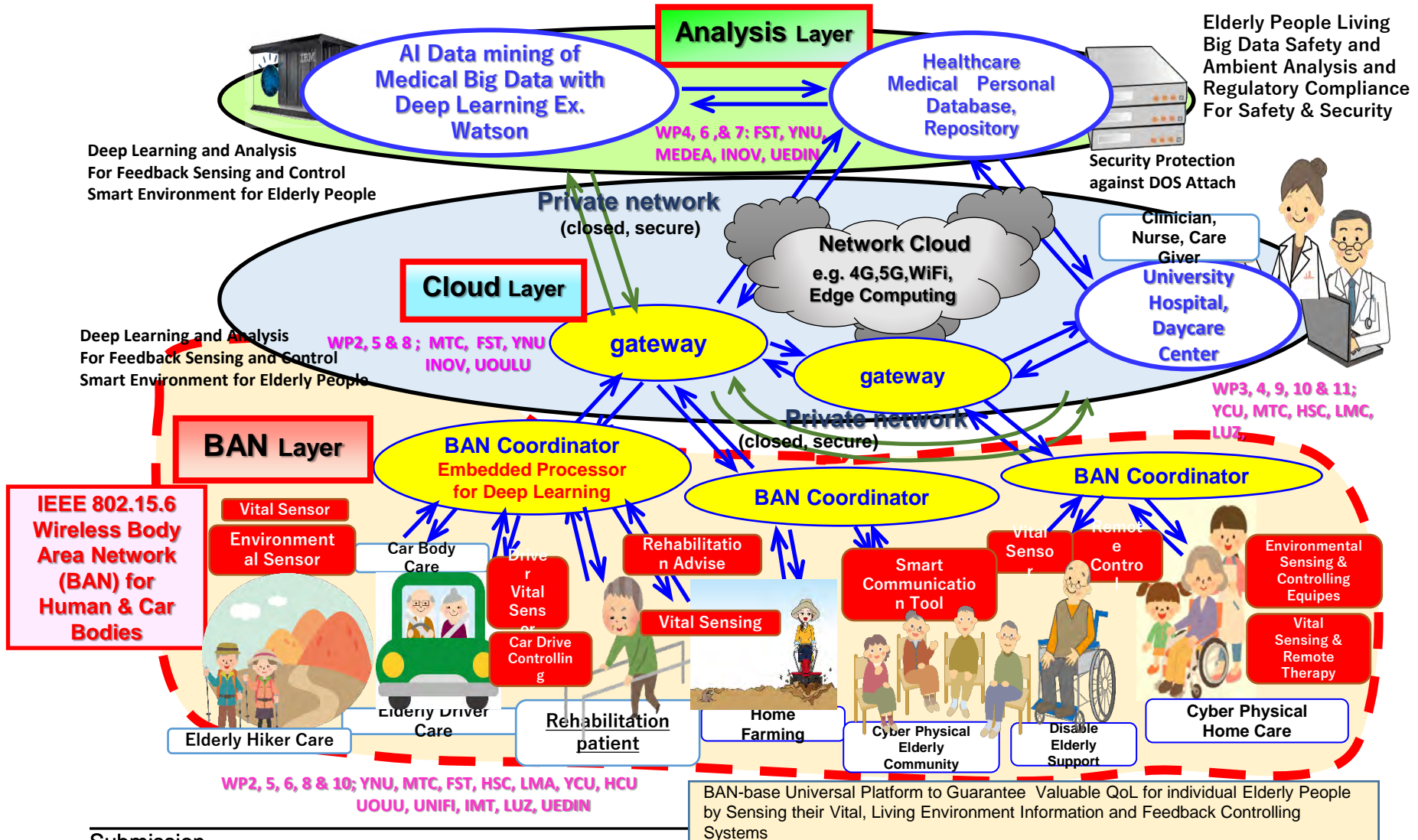

1.7 Extension of Use Cases of BAN beyond Medical Healthcare

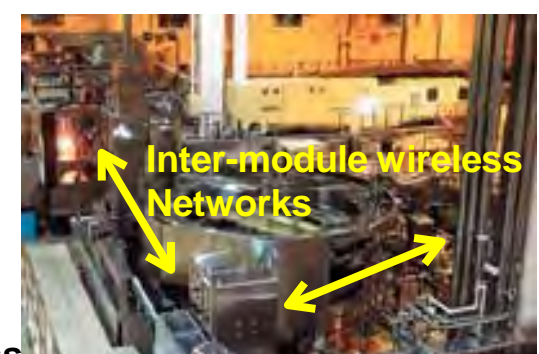
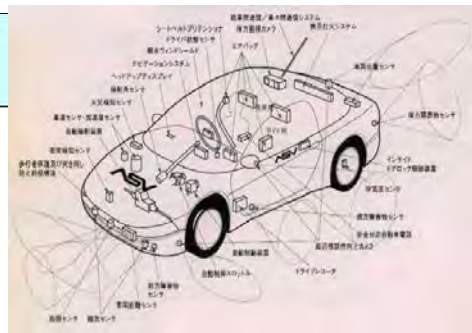
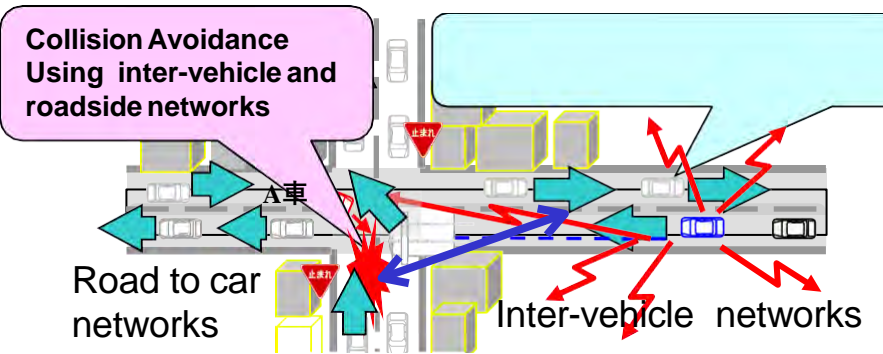

Car Navigation & Collision Avoidance Radar

Car LAN & Wireless Harness

Factory Automation (FA)

Dependable Wireless Networks for Transportation

Dependable Wireless Sensing & Controlling for Manufacturing (CIM)

Wearable BAN

Implant BAN

Tele-metering vital data

Tele-controlling implant devices

- EEG.
- ECG,
- Blad Pressure
- Temperatute
- MRI images
- Etc.

Pacemaker with IAD

UWB can solve such a problem = that radio interferes a human body and medical equipments

Dependable Network among vital sensors, actuators, robots

Capsule Endoscope

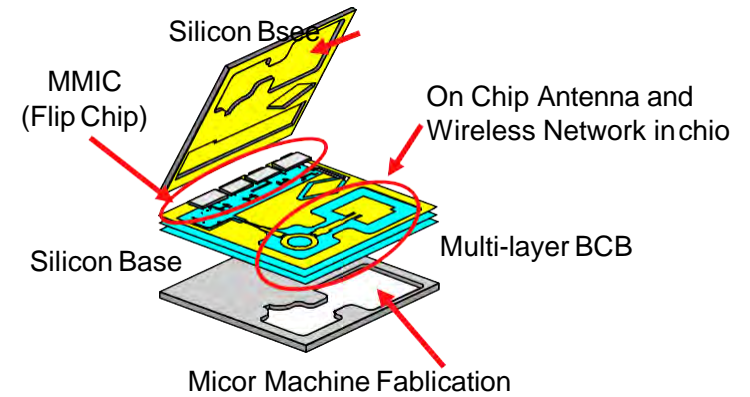

Dependable Wireless System Clock in Micro Circuit & Network in Devices

Dependable BAN for Medical Healthcare

(2) BAN Platform Use Cases in Remote Treatment for COVID-19 Patients under Quarantine at Home

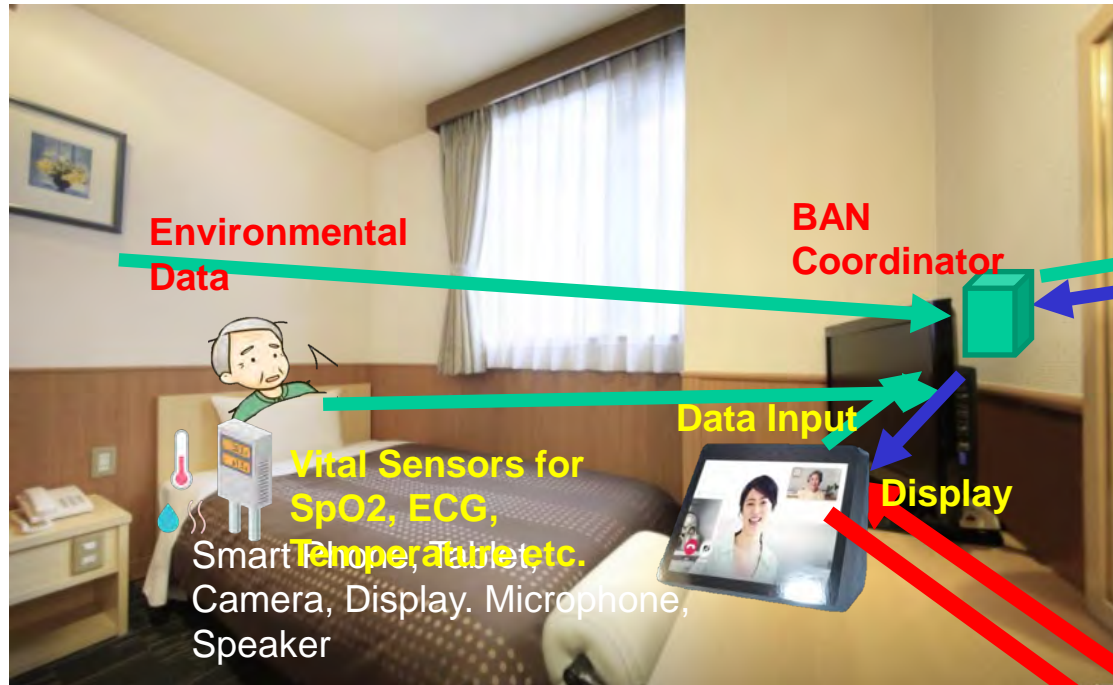

Environmental Data

BAN Coordinator

Data Input

Display

Vital Sensors for SpO2, ECG, Temperature, etc.

Smart Camera, Display, Microphone, Speaker

Remote Maintenance of COVID-19 Patients at Home Using Platform of Integrated Vital Sensors/Wireless BAN/5G Cloud/AI Analysis

Family

Analyzed results for health condition

Integrated Data

Remote Therapy and mental care keeping distance

Real-time remote monitoring and care

Dialog

Data Collection and Analysis

Cloud Remote Monitoring Service

Without Clinical Staffs, health condition of COVID-19 patents can be monitoring and rescue them immediately.

Analyzed results

Command for care of patients



Medical Care Center and Government Control Center

(2) Remote Monitoring and Analyzing Vital Signs and Feedback Using the BAN/Cloud/AI Server Platform (Use Case 1: at home)



Wearable ECG, Pulse , Temperature Sensor



Wearable SpO2 Sensor



In going sleep with wearable vital sensors



Sleep analysis with a bed set ECG sensor

(Use Case 2: in rehabilitation, Use Case 3: in working at home)



Walking rehabilitation with sandal sensor

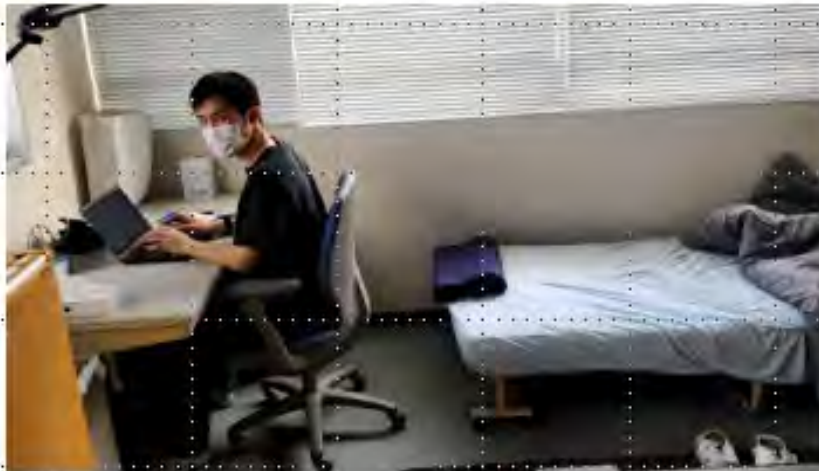

Mental analysis in remote working

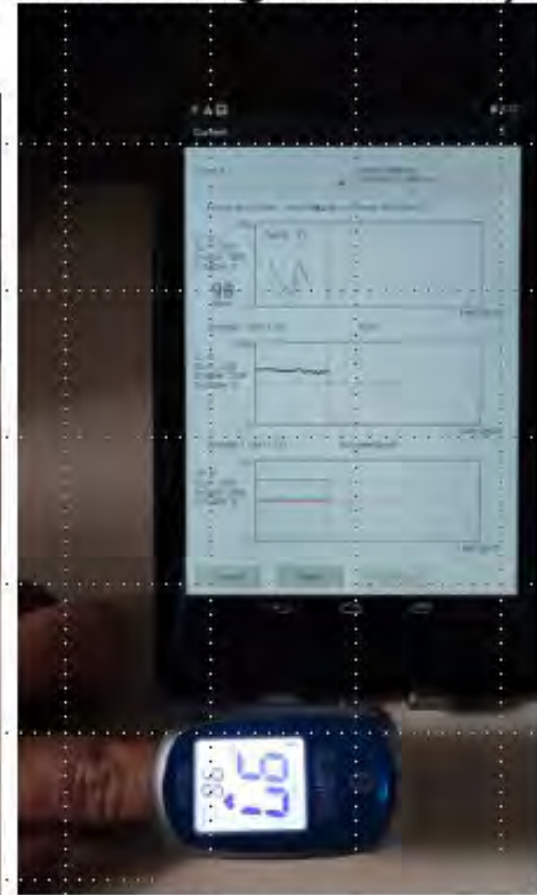

**Tablet Viewer for Multiple Vital Sensors.
Any Existing Sensors are connectable by
our Developed Wireless BAN**

(Use Case 4: in jogging)



Remote monitoring a person with wearable vital sensors in jogging

(Use Case 5: with wheelchair)



Remote monitoring a person on a wheelchair installed vital sensors and remote controller for the wheelchair

(3) Universal Platform with Integrated ICT, Robotics and AI by Remote Sensing and Mining of Vital Data for High Quality of Life with Medicine, Wellness, and Sport

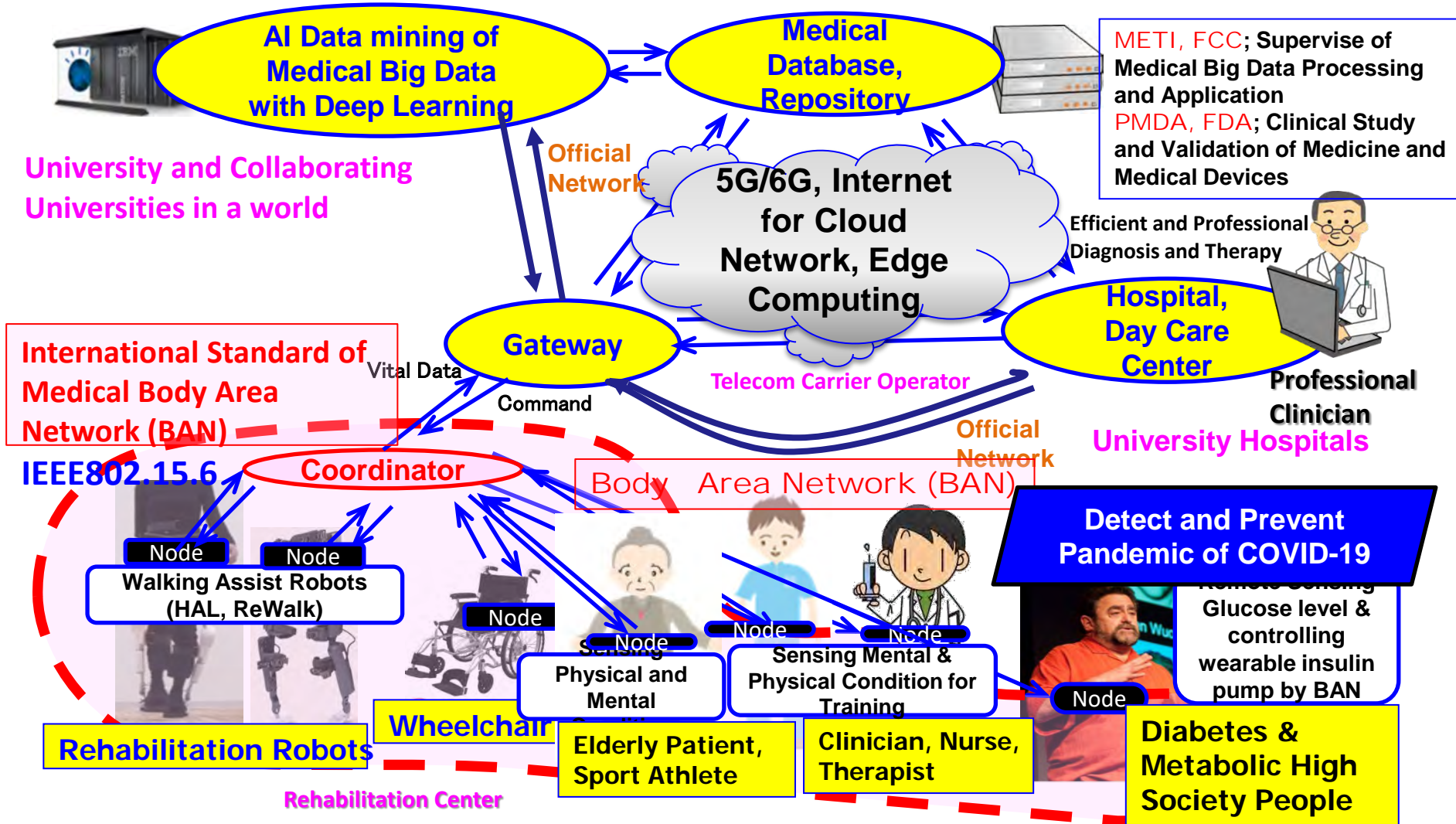

(4) General Platform for Elderly and Disability Care

High QoL of Disabled People by Remote Humanitarian and Health Case Using BAN-base Platform with Cloud Network and AI Server

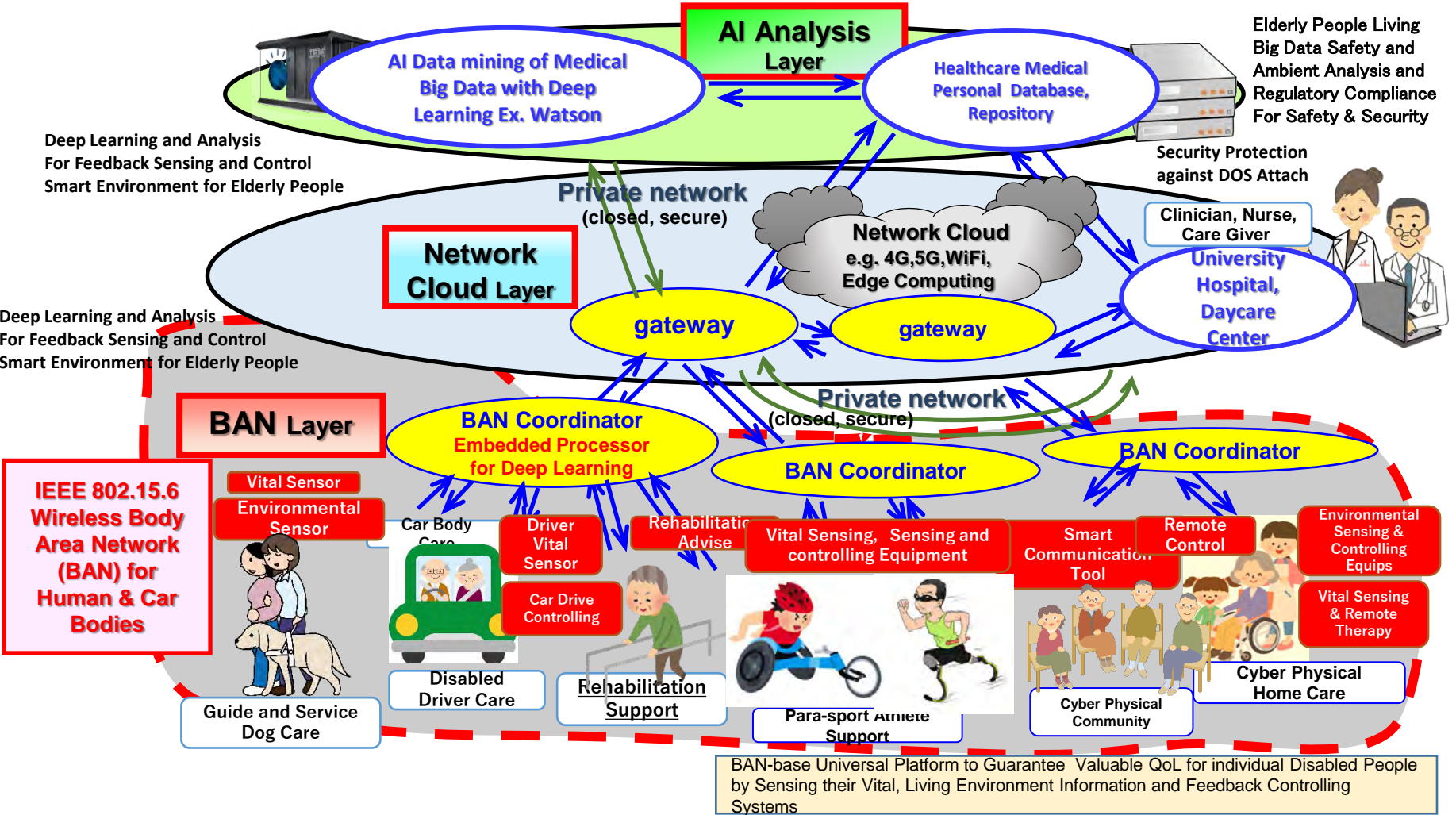

1.8 Demand of BAN for Automotive Uses

A. Increasing Demands in a world:

- **New business promotion by applying wireless ICT to vehicle by huge alliance between automotive and telecom industries such as smart key, wireless harness**
- **Autonomous car driving and safety controlling of elderly drivers by ICT and data science**



Smart Vehiles



EV and HV

B. Challenging but Feasible Solutions:

- ◆ **Provide Remote Sensing and Controlling Using ICT and AI**
→ **Prevent Traffic Accidents , Jam and Co2 Emission**
- ◆ **Promote a New Global Business of Automotive , ICT, and Electronics**



C. Approach:

- (1) R&D of Enable Technologies for Smart Vehicle and City
- (2) Promote International Standard of **Wireless Body Network(BAN) and Integrated Platform of BAN/5G/AI** for Global Marketing **for both Medical and Automotive uses**
- (3) Regulatory Compliance of Devices & Services to Ensure Safety, Reliability, Security, i.e. Dependability by **Regulatory Science**

(1) Dependable BAN of Things for Autonomous Driving Cars

- 4-6 Mono Cameras
- 1-2 Stereo Cameras
- 2-4 Mid-Range Radar
- 2 Long Range Radar
- 8-16 Ultrasonic Sensors, 4 Wheel Speed Sensors
- Redundant Data Center
 - Number Crunchers for Data Fusion
 - ABS, ESP, ...
 - Some ECUs we can't tell you details today ☺
- Interaction with Powertrain, Body Domain, Navigation, Airbag, CAR2CAR, CAR2Infrastructure



Automated Driving is leaving the Research Labs.
Soon it will be in mass production.

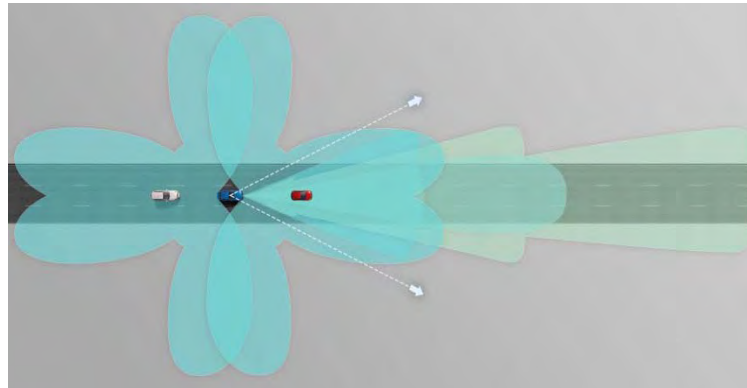

For automotive, Inter-vehicle communications(IVC) and Machine-to-Machine(M2M) inside a car like brake-axcel control must be core applications of Dependable BAN of Things.

1.9 Use of BAN for Autonomous Car Driving

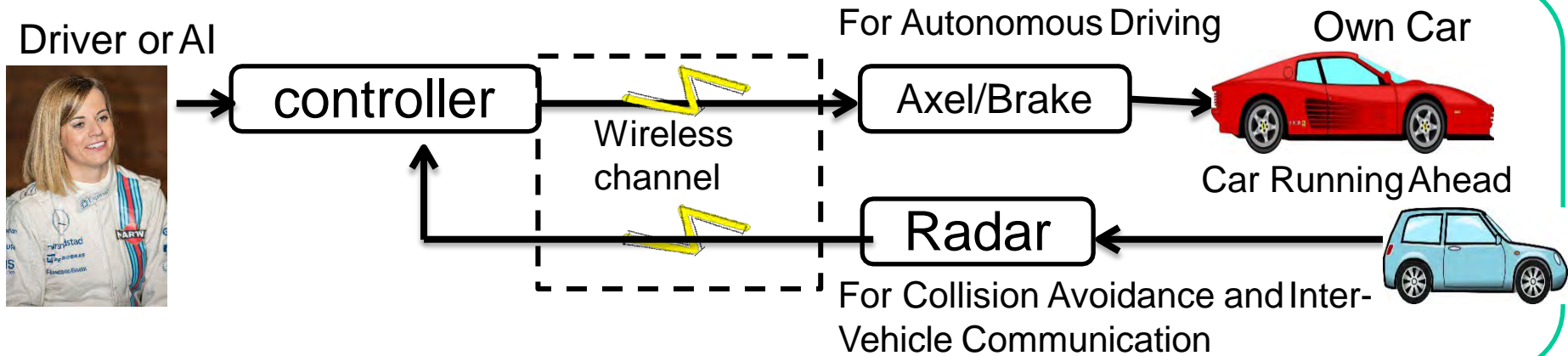

Wireless Feedback Sensing and Controlling Loop for Autonomous Driving

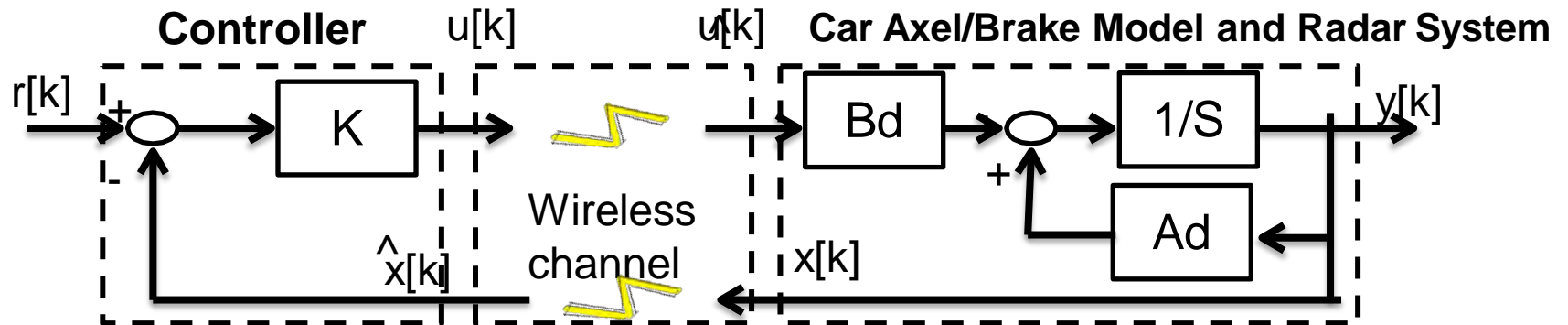

Feedback Delay Loop Model with Motion Equation

(2) Demands for Dependable Wireless Network in Factory Automation(FA)



Demands for Internet of Things increase but Machine-to-Machine (M2M) should be reliable and secure, so Dependable BAN for Medicine can be applied for Dependable BAN of Things.

1.10 Remote Localization and Rescue of Missing Victims Using Wireless Dependable BAN of Things/M2M

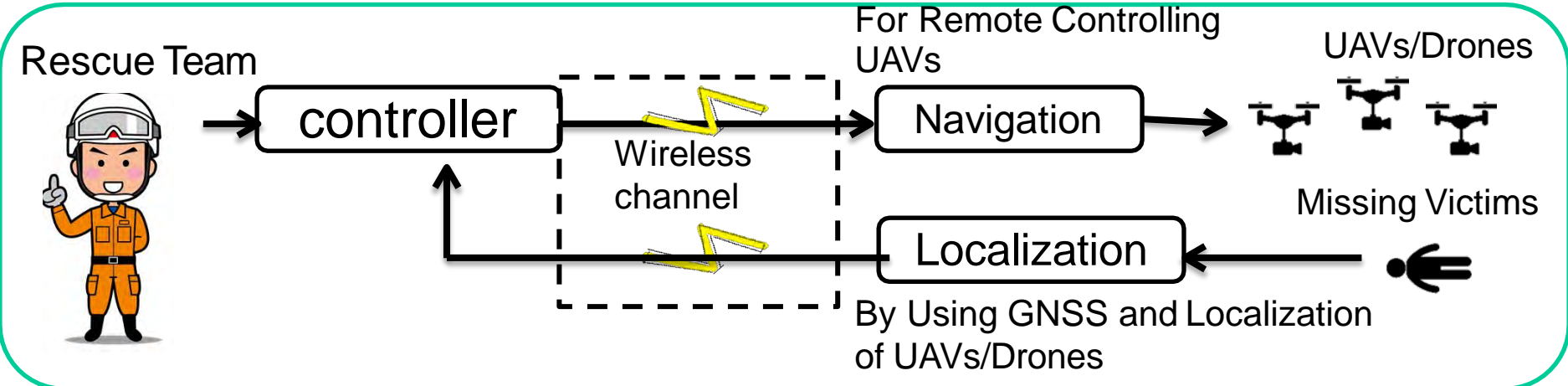

Wireless Feedback Sensing and Controlling Loop for Rescue of Victims

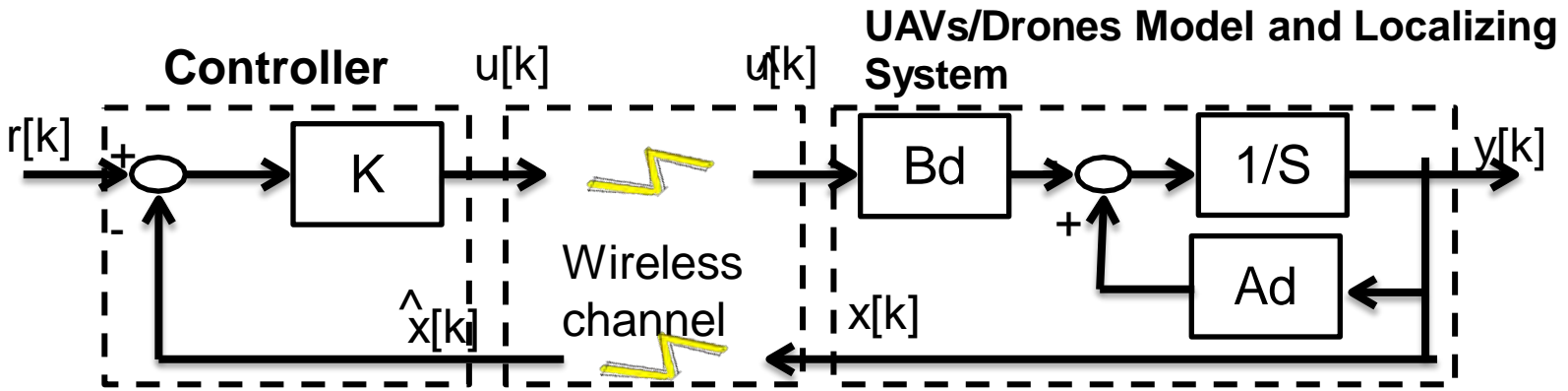

Feedback Delay Loop Model with Motion Equation

(1) NZ(UC)-Japan(YNU) Joint Project ;

Dependable Wireless Body Area Networks to Support Search and Rescue and Medical Treatment in Disaster Scenarios Using Multiple UAVs

GNSS: GPS, GLONAS, BeiDou, QZS (Quasi-Zenith Satellite System)

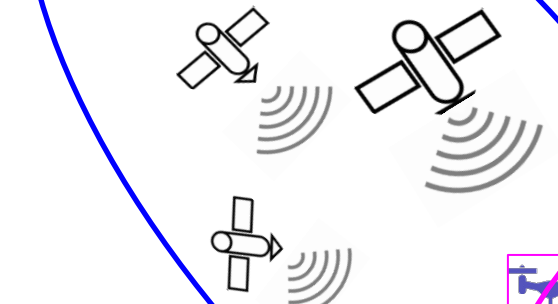

Step1; Positioning for anchor node UAVs using GNSS

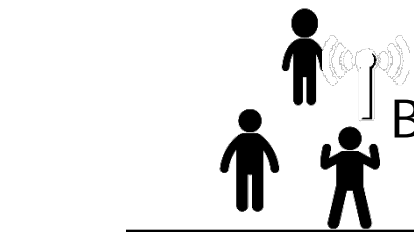

Step2; Expanding UWB ranging area by recursive process

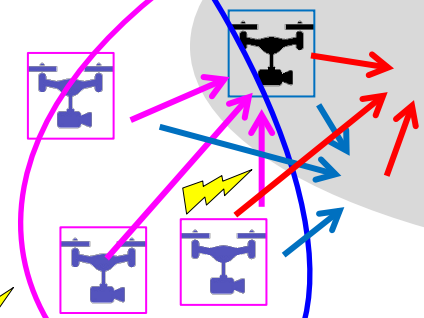

Step3; Localization of victim by TDOA ranging with UWB-BAN

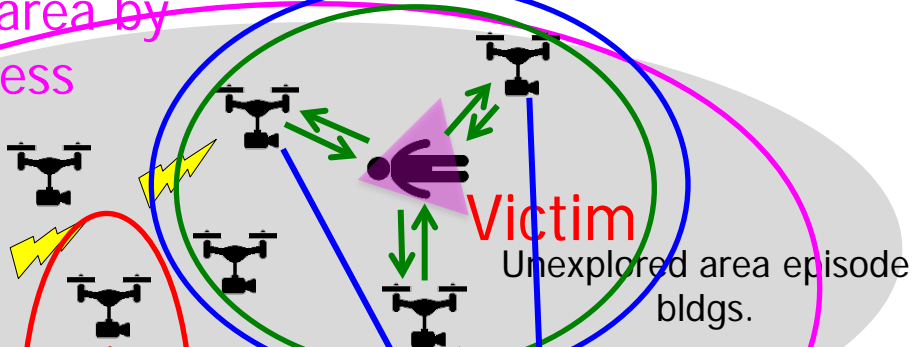

Step4; Triage using sensed vital signs from UWB-BAN



Step5; Wireless power transmission to recharge battery of UAVs

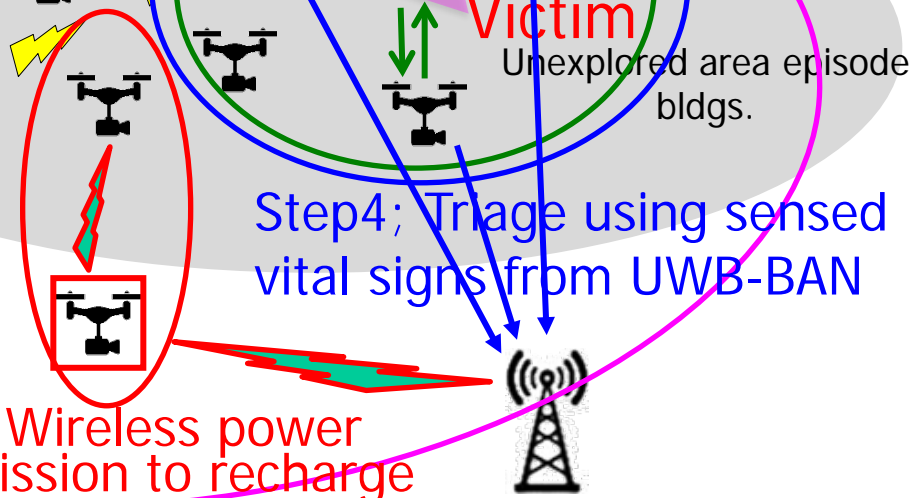

mobile's base station

1.11 Body Area Network(BAN) of Vehicle Body

Motivation to extend human BAN(HBAN) to VBAN is to promote much dependable services by interaction between HBAN and VBAN.

Use case of Vehicle Body Area Network(VBAN) for Engine Room

1. Engine diagnostic sensor and controller
2. Air pressure sensor, wheel health sensor and controller
3. Transmission monitoring sensor and controller

Use case of Vehicle Body Area Network(VBAN) for Cabin Room

4. Cabin environment sensor (temperature, brightness, humidity etc.)
5. Sheet sensor, health care sensors for driver
6. Sheet sensor, health care sensors for passenger

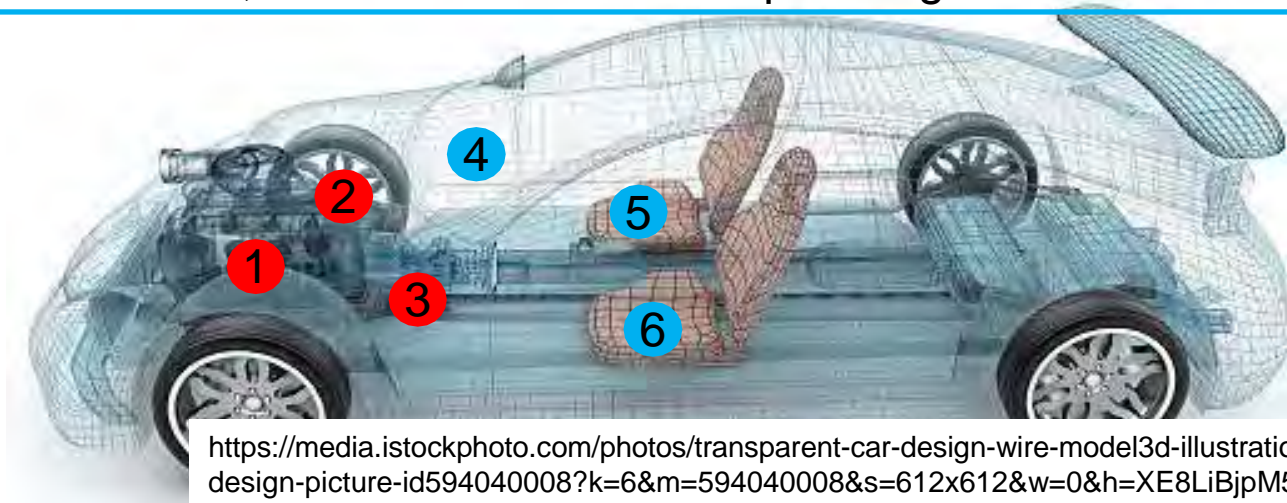

<https://media.istockphoto.com/photos/transparent-car-design-wire-model3d-illustration-my-own-car-design-picture-id594040008?k=6&m=594040008&s=612x612&w=0&h=XE8LiBjpM51aB4pH2CFt6-MT6lvALRPnlxPcac0RXhg=>

1.12 Use case in Factory Manufacturing Line; Detection of Twist and Cut of Cables

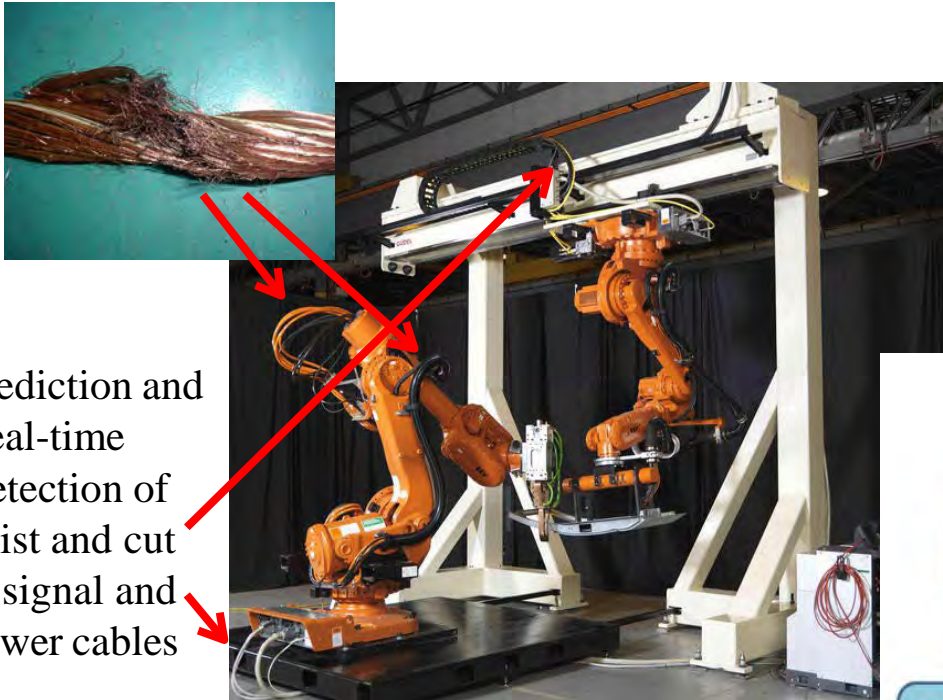

Prediction and Real-time Detection of twist and cut in signal and power cables

In order to improve QoS of controlling robots in factory lines, real-time sensing and controlling with permissible feedback control loop must be important requirement

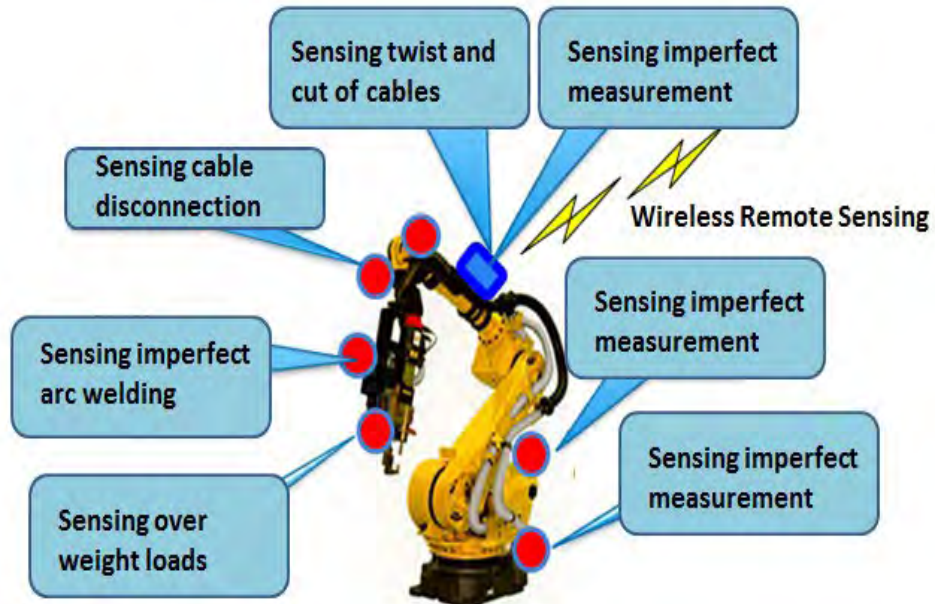

1.13 BAN/5G/AI Platform for Safe Aviation of Flying Vehicles as Air-MaaS (Mobility as a Service)

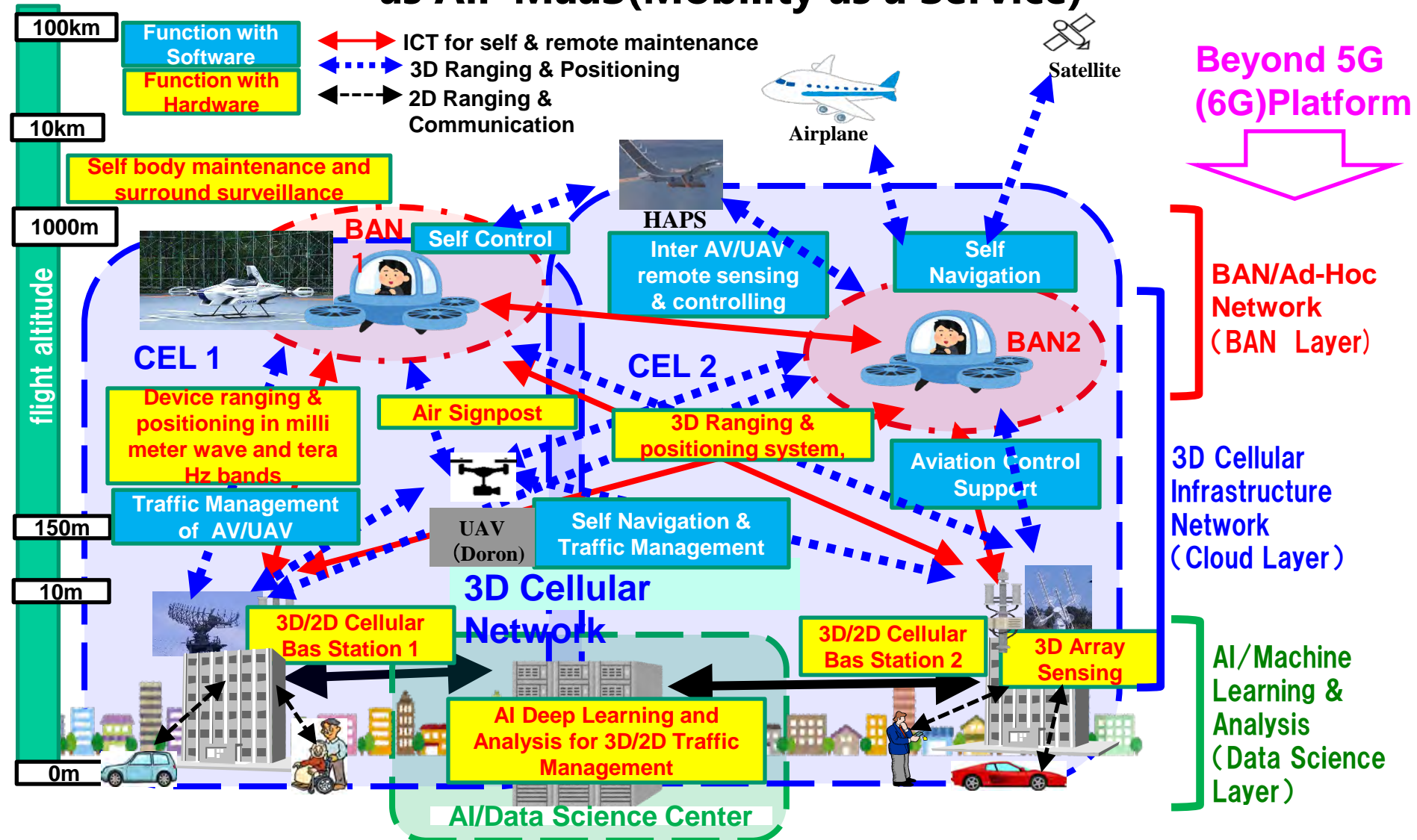

1.14 High Quality of Life by Parasports Supported by Wireless BAN, Network Cloud, Assisting Robots, AI Data Science

1. Guarantee Safe and Enjoyable Training and Games for Parasports ex. Chair Basketball & Ski
2. Fair Judgement of Sport Games with Wireless Sensing

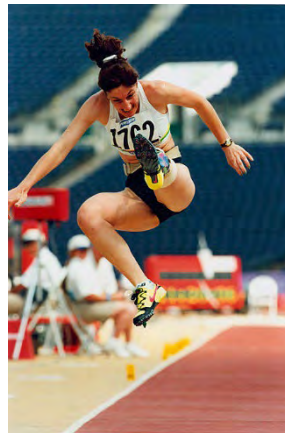

1.15 Applications of BAN Platform for Entertainment and Sports beyond Medicine, Wellness and Wellbeing



Jogging with BAN-chip installed MP3 Player

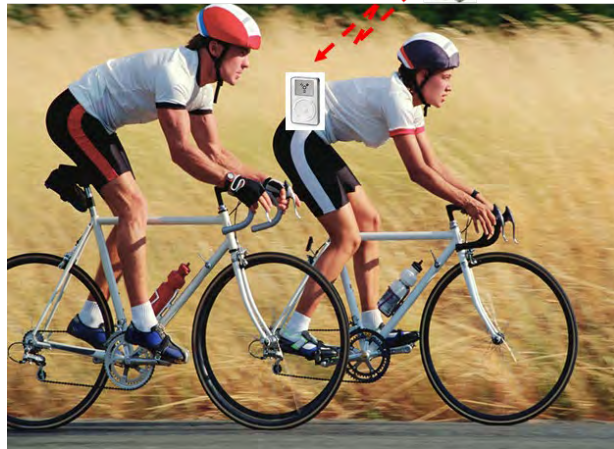

Bicycle with BAN-chip



Wearable BAN-chip for wireless vital sensing & controlling, audio, video source sharing for sport

1.16 Universal Platform to Achieve All SDGs



1.17 Approach: Advanced ICT and Data Science to Achieve All of SDGs

Solving Social Problems

Communication between Humans and Things



Expansion of Communication Environment

Sophistication of Cyber-Physical Fusion

1.18 Future Vision of Dependable Social Infrastructures Based on ICT& Data Science

Major 5 Infrastructures of Communications, Transportation, Energy, Commerce and Medicine

- A. Information Traffic (Telecommunications)
- B. Vehicular Traffic (Transportation)
- C. Energy Traffic(Power & Energy Supply)
- D. Money Traffic (Commerce)
- E. Patient, Drug Traffic(Medicine)

A+B → **ITS & Autonomous Driving (Intelligent Transport System)**

A+C → **Smart Grid & WPT (Wireless Power Transmission)**

A+D → **E-Commerce (Borderless Secure Trade)**

A+E → **Medicine ICT & Digital Health(Ubiquitous Medicine)**

should be integrated to control all flows in future infrastructure

Aiming Development and Sustainable Operation of Dependable Social Services

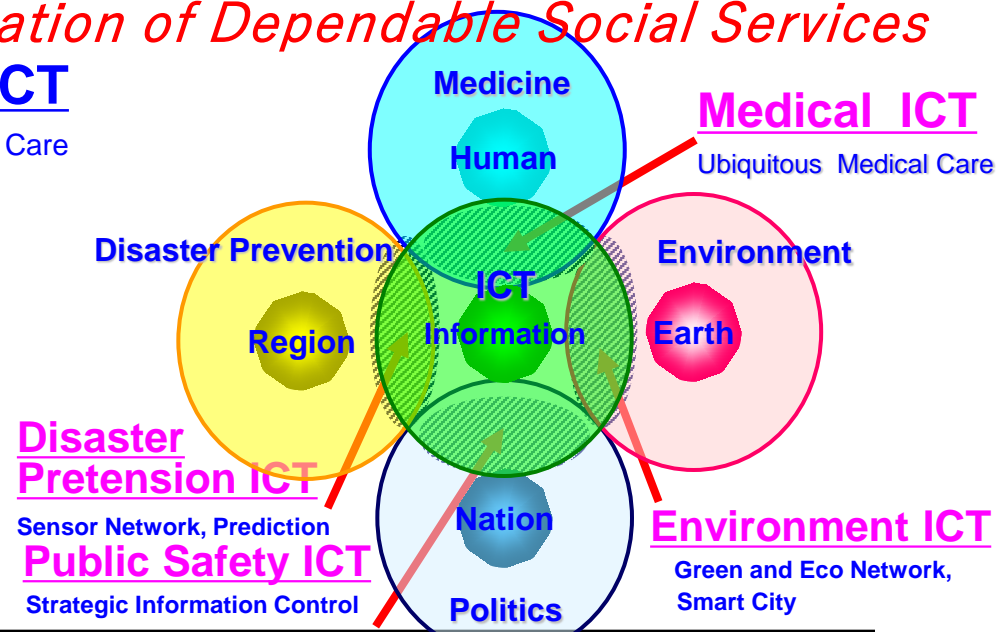
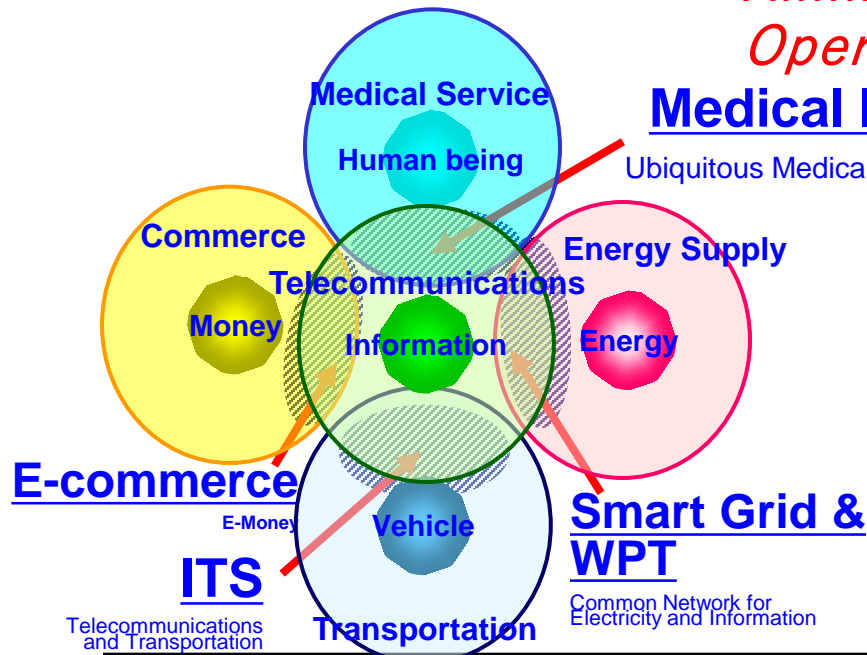

1.19 Demands of Dependable BAN of Things in IoT/M2M



1.19 Common Secure and Dependable Social Infrastructure Platform Based on integrated BAN/Cloud/AI Server

BAN of Things

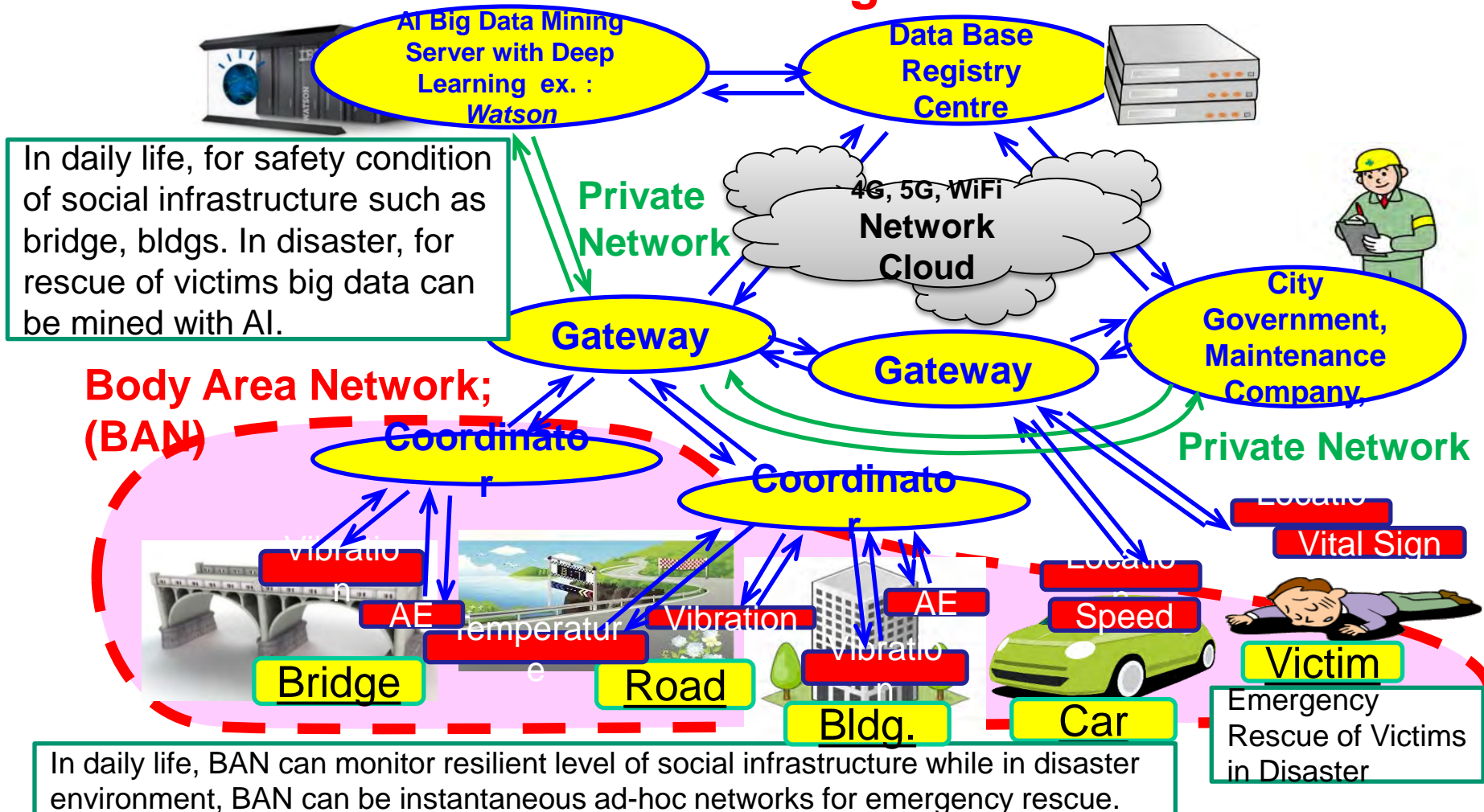

2. Short Review of WBAN Standard IEEE802.15.6-2012

2.1 Standard of Medical Wireless Body Area Network (BAN);IEEE802.15.6

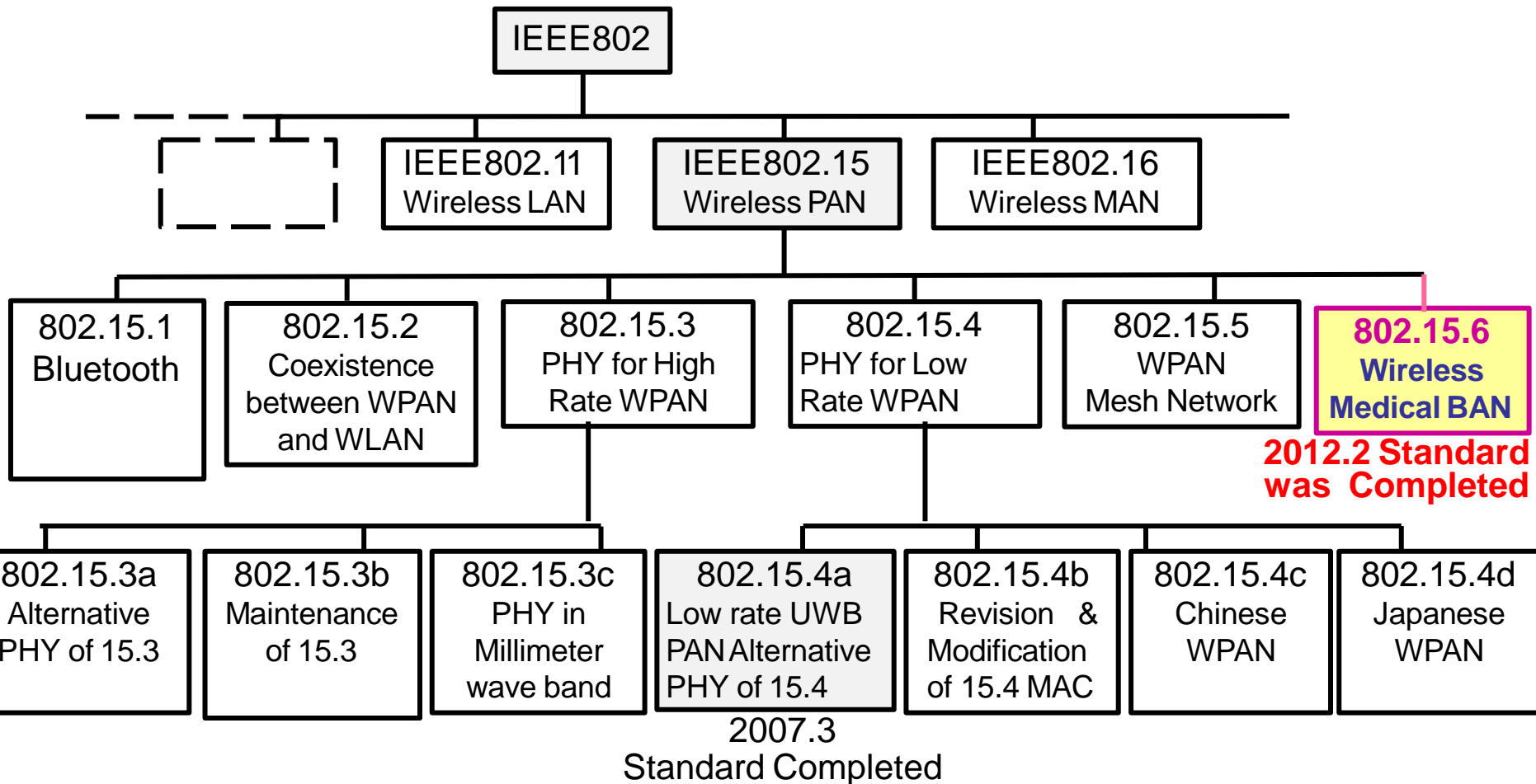

2.2 Top View of IEEE Std 802.15.6

Coexistence?

Power consumption?

Outage probability?

Complexity?

Security?

Reliability?

IEEE 802.15.6

Narrow band PHY
on-body & in-body

UWB PHY
on-body

HBC PHY
on-body

Common MAC
(for all PHY)

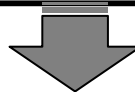
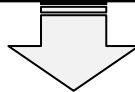
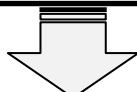
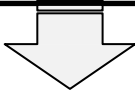

- Modulation: GMSK & DPSK
- TX range: ~3m
- Bands: MICS, WMTS, ISM
- Data rate: ~ some Mbps

- Modulation: IR-UWB & FM-UWB
- TX range: ~3m
- Band: UWB band
- Data rate: ~10Mbps

- Frequency Selective
- 10-50MHz
- 125kbps-2Mbps

- Beacon-base-TDMA
- Group Superframe
- Priority support
- Non-beacon mode

UWB: Ultra-wideband
HBC: Human body communication

2.3 User Priority Mapping

Priority level	Traffic designation	Data type
7	Emergency or medical event report	Data
6	High priority medical data or network control	Data or management
5	Medical data or network control	Data or management
4	Voice	Data
3	Video	Data
2	Excellent effort	Data
1	Best effort	Data
0	Background	Data

2.4 Three Channel Access Modes

Channel access mode	Time reference-based (superframe structure)	Beacon	Notes
I	Yes	Yes	Coordinator sends beacon in each superframe except for inactive superframes.
II	Yes	No	Coordinator establishes time reference but doesn't send beacon.
III	No	No	There is not time reference.

2.5 Time-referenced Superframe w/ Beacon

Clock and position of each access phase

May obtain contended allocation for highest priority

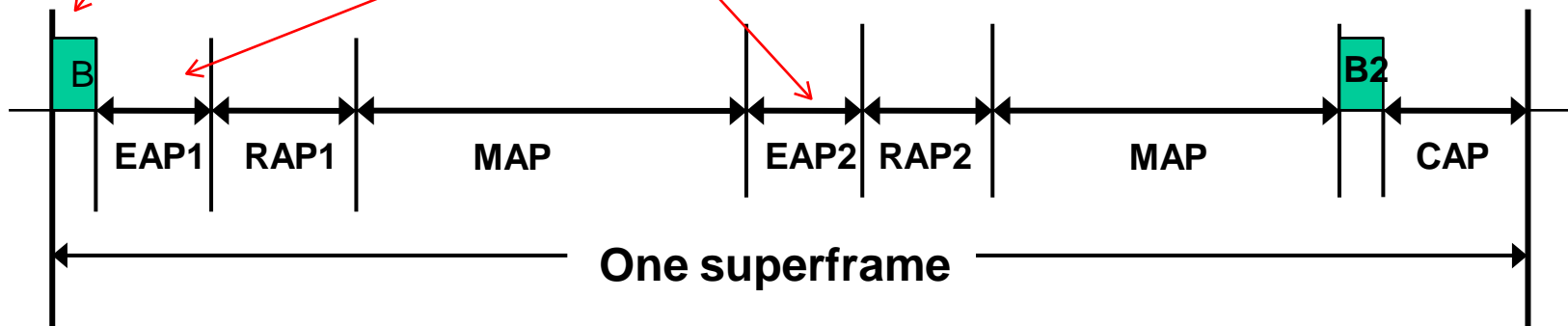

EAP: exclusive access phase

RAP: random access phase

MAP: managed access phase

CAP: contention access phase

2.6 Dependable MAC for IEEE802.15.6ma

- To enhance dependability in MAC layer, IEEE802.15.6 has applied a **hybrid contention free and contention access MAC protocol** in which high QoS level of packets have transmit without delay in **contention free period (CFP)** while low QoS level of packets with permissible delay in **contention access period (CAP)**.

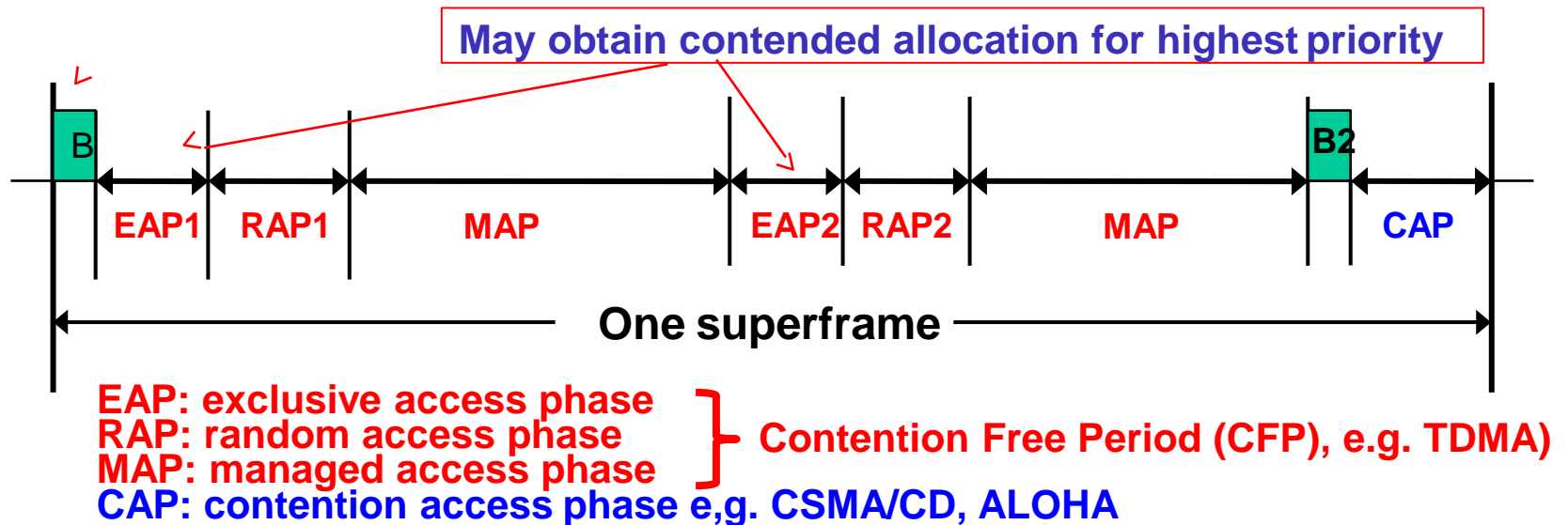

3.2 Technical Challenges for Enhanced Dependability

- First of all, we should recognize that any technology in PHY and MAC cannot guarantee full dependability in every use case.
- However, we can design a new standard which can guarantee a certain level of enhanced dependability in a specific defined use case.
- As an analogy of informed consent in medical doctor to a patient, a manufacturer of a dependable wireless network can describe such a specific defined use case that **the manufacture can guarantee a defined level of dependability showing necessary cost and remained uncertainty.** This is an honest manner and much better than no guarantee for any use case.
- Therefore, an expecting standard describes a specific use case in which **worst performance can be guaranteed enough high while most of exiting standards have been designed with average performance base.**
- Technical requirement for the specific use case can be guaranteed.

3.3 Uniqueness different from existing standards (1/2)

1. MAC protocol for around packets and recursive access for feedback loop in remote sensing and controlling;
2. Level of dependability can be defined with showing necessary cost and remained uncertainty. This is an honest manner and much better than no guarantee for any use case.
3. Worst performance can be guaranteed enough high while most of exiting standards have been designed with average performance base.
4. Others

3.3 Uniqueness different from existing standards (2/2)

Physical(PHY) layer Technologies to satisfy technical requirement for enhanced dependability in the focused use cases

- A) In feedback loop for remote monitoring sensors or radars and feedback controlling actuators, real-time cognition of varying condition on site and adaptive reconfiguration in relatively messy, small, and dense areas are requested to guarantee worst performance with permissible delay and errors.
- B) Within a permissible limited feedback delay, propagation paths connecting between nodes and coordinator should be found to keep connectivity by diversity, channel switching etc. .
- C) For such a dynamic environment and QoS requirement changing situation, sophisticated PHY technologies are requested to guarantee minimum requirement of performance.

3.4 Focused Issues in Amendment of std 15.6 BAN with Enhanced Dependability

1. MAC Protocol in case of coexistence of multiple BANs

- Amendment of MAC for resolving these problems in coexistence of BANs is necessary.
- Specified MAC protocol for feedback sensing and control loop between coordinator and nodes.

2. PHY Interference Mitigation In case of coexistence with other radios

- For enhanced dependability, UWB PHY of BAN should be updated to avoid performance degradation due to interference with coexisting other narrow band and UWB networks in overlapped frequency band.

3. Usability and Implementation Complexity

- Interoperability with narrow band and UWB PHY
- more flexible network topology,
- Transparency with other standards such as ETSI SmartBAN

4. Ranging and Positioning Capability of UWB-BAN

- Mobile nodes and coordinator of BAN need ranging and positioning of UWB-BAN

4. Channel and Environment Models for Focused Use Cases for Revision of std 15.6-2012 for Human and Vehicle BANs with Enhanced Dependability TG16.6ma

4.1 Channel models and scenarios in IEEE802.15.6ma

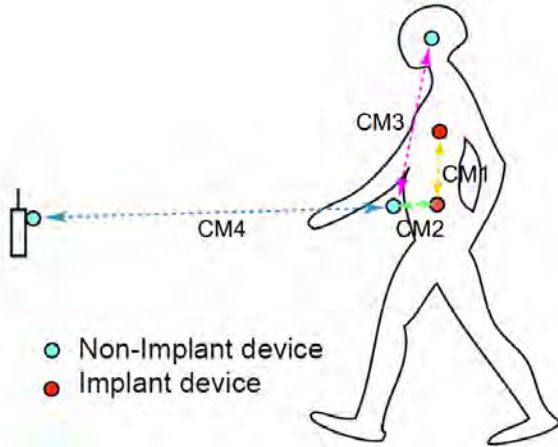

- Path loss (Mandatory)
 - Optional;
 - Fading (Small scale/ large scale)
 - Shadowing
 - Power delay profile
- Specific use cases**

Implant to Body Surface for BCI
Implant to External for BCI
Body surface to body surface for BCI
Body Surface to External for BCI
Implant to body surface for capsule endoscopy

Scenario	Description	Frequency Band	Channel Model
S2	Implant to Body Surface	402-405 MHz,	CM2
S2.1	Implant (upper body) to Body Surface	3.1-10.6 GHz UWB	CM2.1
S2.2	Implant (head) to Body Surface	3.1-10.6 GHz UWB	CM2.2
S3	Implant to External	402-405 MHz, 3.1-10.6 GHz UWB	CM2
S4	Body Surface to Body Surface (LOS)	400, 600, 900 MHz 2.4, 3.1-10.6 GHz	CM3
S4.1	Body Surface to Body Surface (LOS)	3.1-10.6 GHz CM4.1	CM4.1
S5	Body Surface to Body Surface (NLOS)	400, 600, 900 MHz 2.4, 3.1-10.6 GHz	CM3
S6	Body Surface to External (LOS)	900 MHz 2.4, 3.1-10.6 GHz	CM4
S6.1	Body Surface (head) to External (LOS)	3.1-10.6 GHz	CM6.1
S7	Body Surface to External (NLOS)	900 MHz 2.4, 3.1-10.6 GHz	CM4

4.2 Brain-Machine-Interface(BMI): Wireless Body Area Network (BAN) with AI Machine-Learning and User-Interface

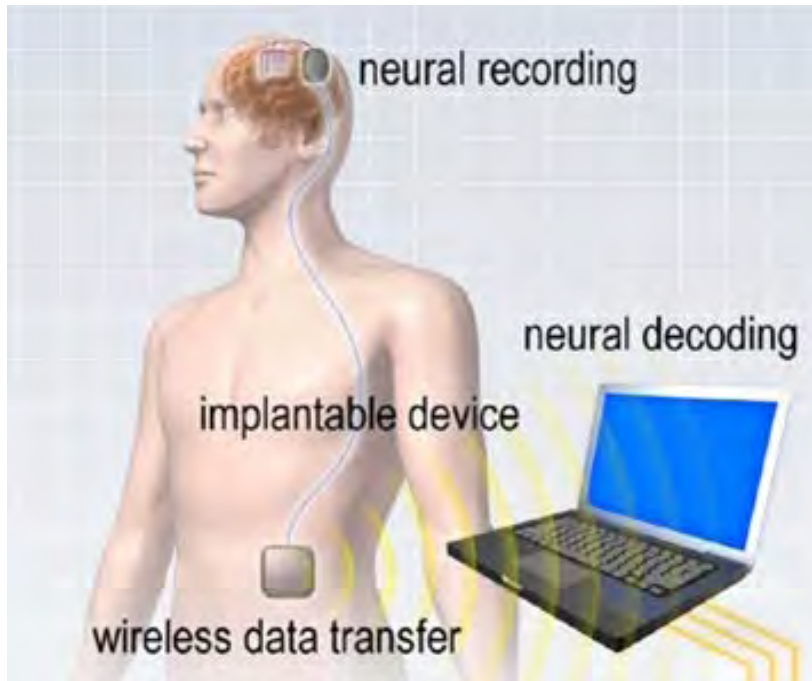

**Brain-Computer-Interface(BCI)
for Understanding Human
Contention and Machine Control.**

**Brain-Computer-Interface(BCI) and
Brain-Machine-Interface(BMI) for
Clinical Support to Disability and
More General Use Cases Including
for Entertainment, e-Game, and
Heavy Industries.**

4.2 BMI with Wireless BAN with AI Machine-Learning and User-Interface

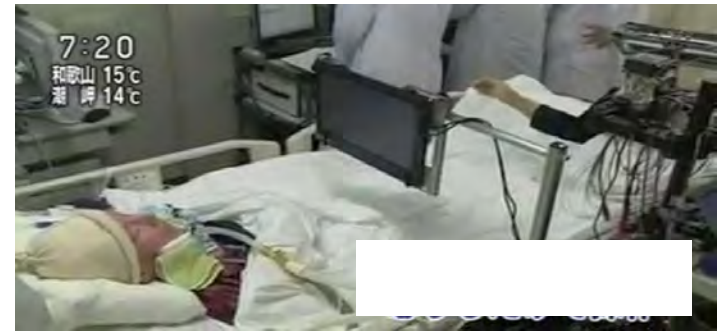
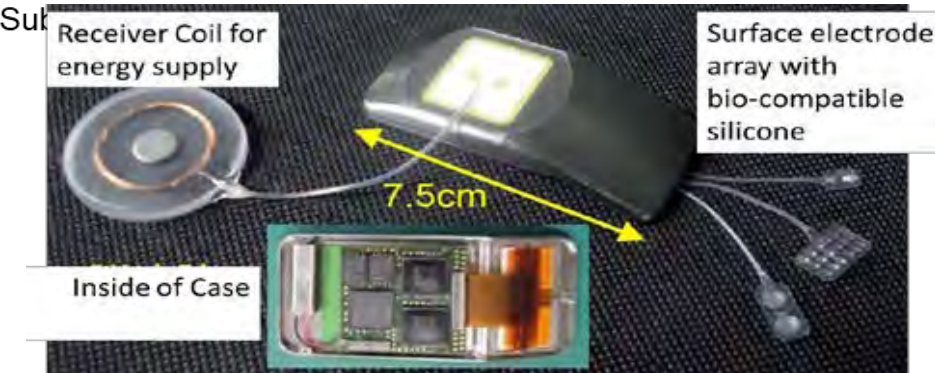
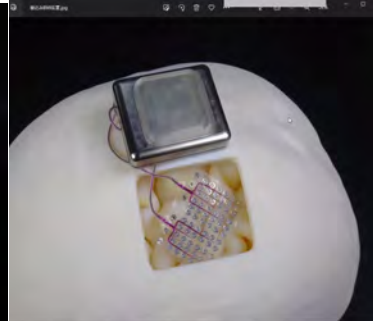
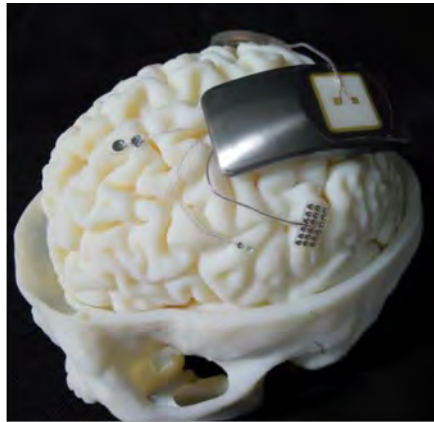
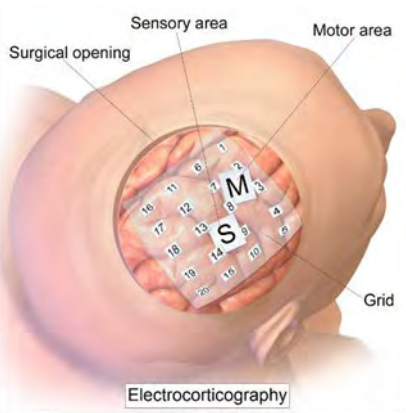

ECoG (Electrocorticogram) detected with implanted thousands of electrodes is transmitted in wireless by BAN with high capacity and dependability.

Brain-Machine-Interface(BMI) systems for Clinical Support to Disability such as autonomous robot hand control and communication assistance.

4.2 Channel models and scenarios in use case of BMI and BCI(Brain-Computer-Interface)

We will define what is BCI and BMI.

Specific use cases
Implant to Body Surface for BCI
Implant to External for BCI
Body surface to body surface for BCI
Body Surface to External for BCI
Implant to body surface for capsule endoscopy

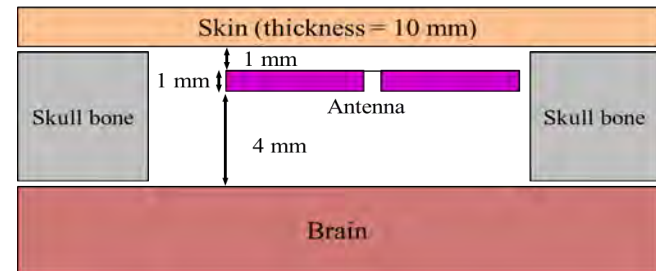
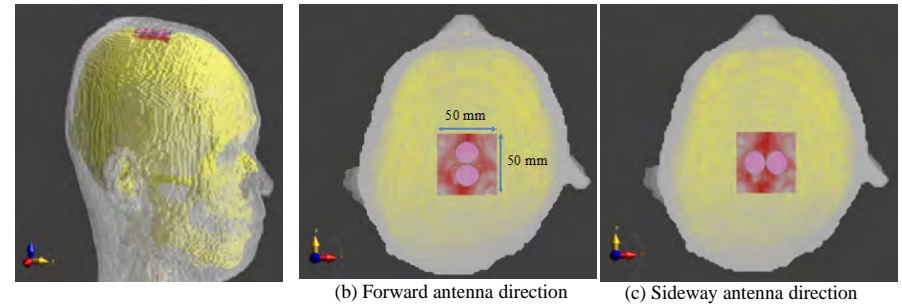
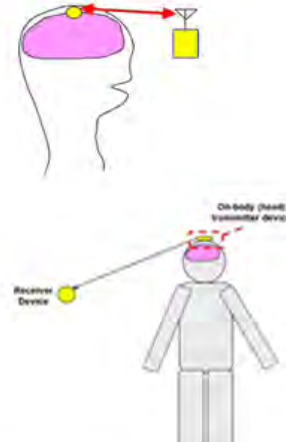
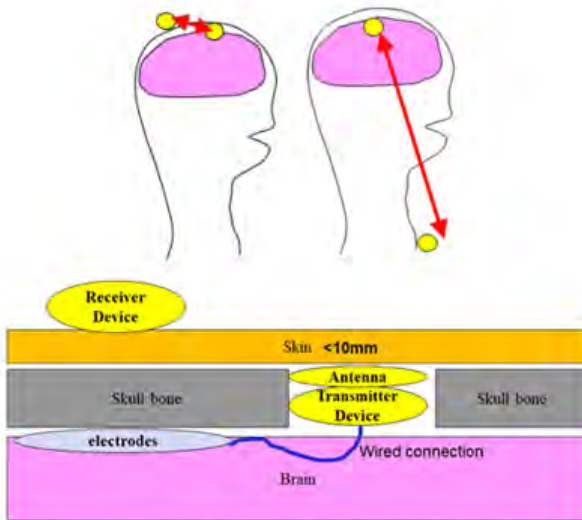

Simulation and measured models of implant transmitters

- Implant to Body Surface for BCI
- Body Surface to External on-body surface for BCI
- Implant to External for BCI

4.3 Channel models and scenarios for capsule endoscopy

Specific use cases
Implant(head) to on-body for BCI
Implant to External for BCI
Body surface to body surface for BCI
Body Surface to External for BCI
Implant to body surface for capsule endoscopy

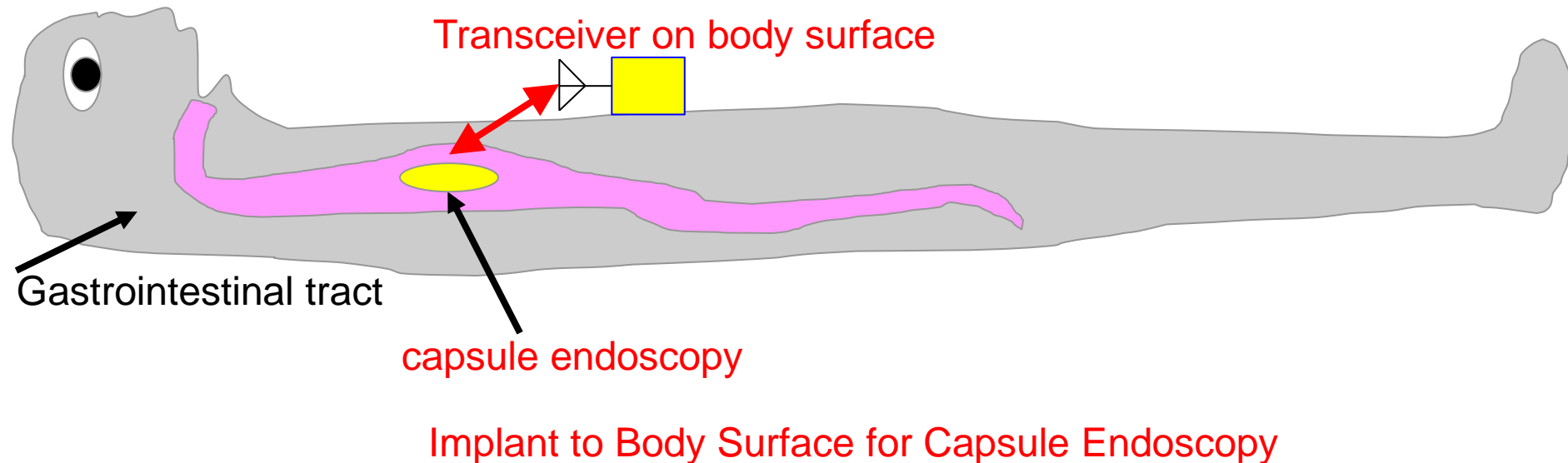

4.4 Channel and Environmental models of VBAN

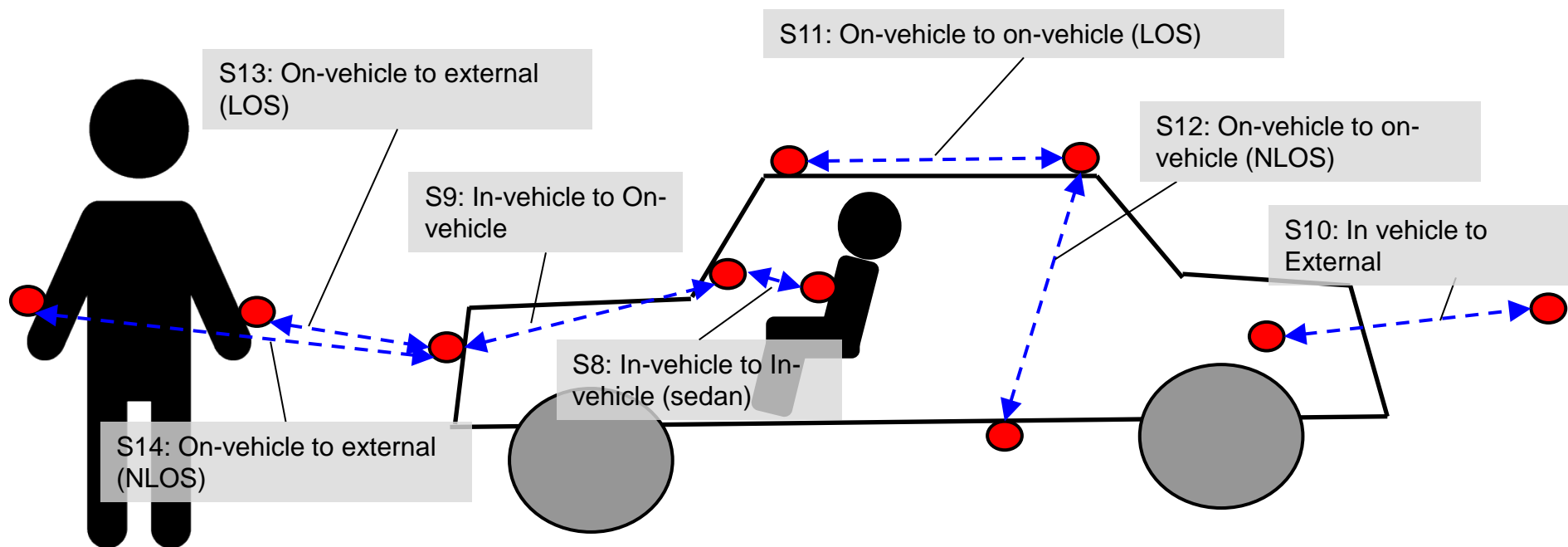

Common Standard of Dependable BAN IEEE802.15.6ma for human and car bodies makes a new market for both medical devices and automotive industries.

For instance, autonomous car safety control for elderly drivers' driving failure to avoid accidents.

4.4 Use Case of Coexisting Multiple HBAN and VBAN

Nodes and coordinator are in cabin room Geometrical configuration

➔ Original channel models, common channel model to IEEE 802.15.4a and IEEE802.15.6-2012

- VBAN Coordinator
- HBAN Coordinator
- Noise source

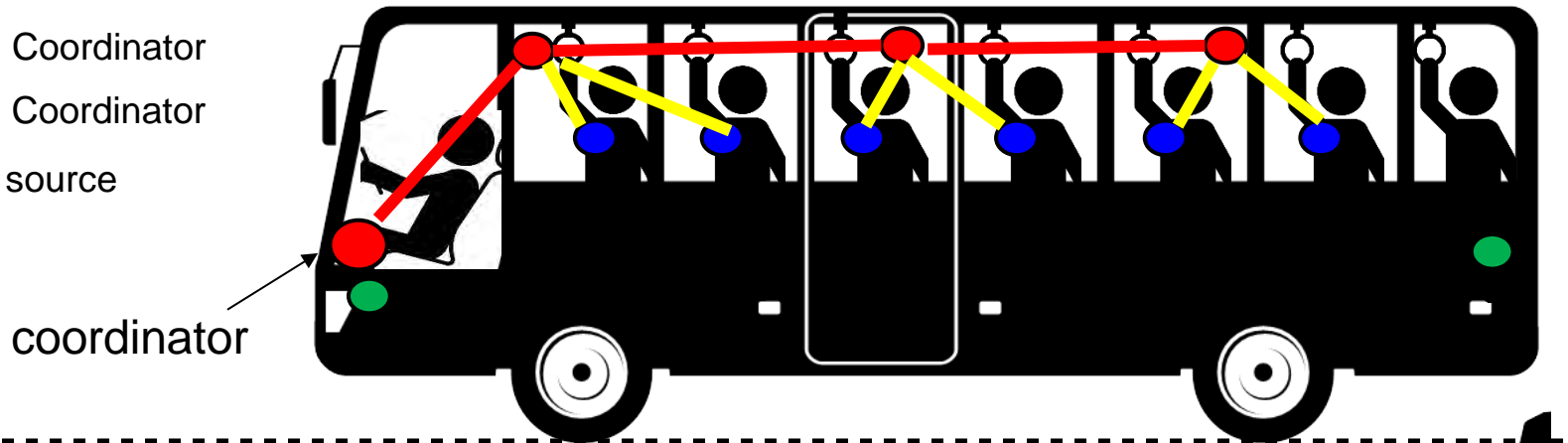

Use case

- Entertainment for passengers
- Nodes are in cabin room / coordinator is in cabin room.

scen ario		Sedan/RV / SUV with engine	Sedan/RV / SUV without engine	Bus	Cargo / pickup	Special purpose
8.1v v	VBAN coordinator and VBAN coordinator	Case 3.1a		Case 3.1a	Same as 3.1a	---
8.1v h	VBAN coordinator and HBAN coordinator	Case 3.1b				---

4.4 Channel models and scenarios in IEEE802.15.6ma

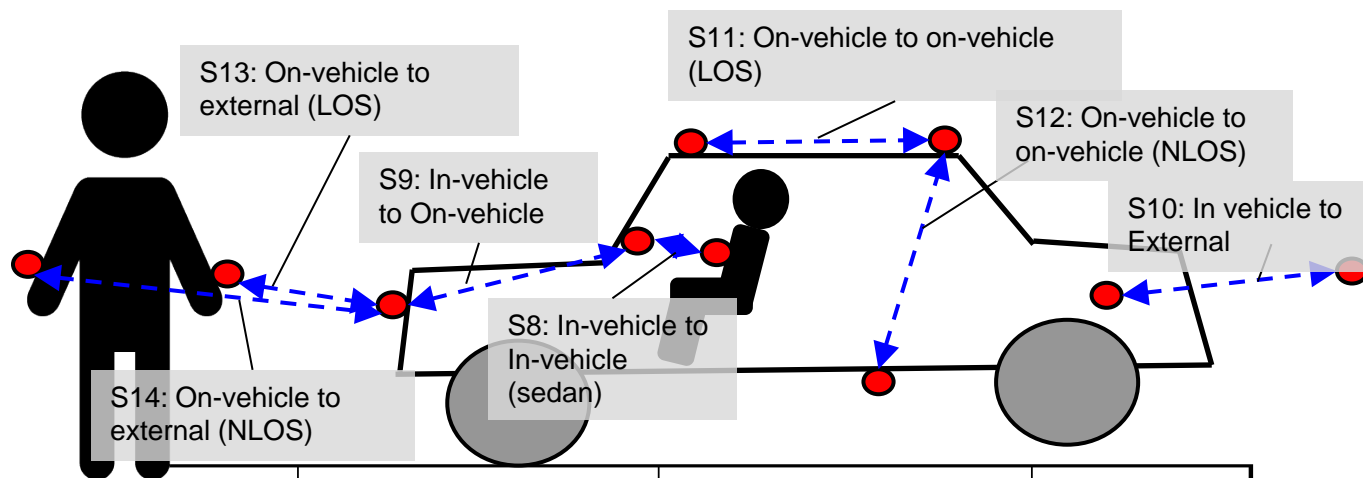

Scenario	Description	Frequency Band	Channel Model
S8	In-vehicle to In-vehicle (sedan)	2.4, 3.1-10.6 GHZ	CM8
S8.1	In-vehicle to In-vehicle (passenger bus)	2.4, 3.1-10.6 GHZ	CM8.1
S9	In-vehicle to On-vehicle	2.4, 3.1-10.6 GHZ	CM9
S10	In vehicle to External	2.4, 3.1-10.6 GHZ	CM10
S11	On-vehicle to on-vehicle (LOS)	2.4, 3.1-10.6 GHZ	CM11
S12	On-vehicle to on-vehicle (NLOS)	2.4, 3.1-10.6 GHZ	CM12
S13	On-vehicle to external (LOS)	2.4, 3.1-10.6 GHZ	CM13
S14	On-vehicle to external (NLOS)	2.4, 3.1-10.6 GHZ	CM14

4.5 Classification of Channel and Environment Models for Human and Vehicle Body Area Networks (HBAN&VBAN)

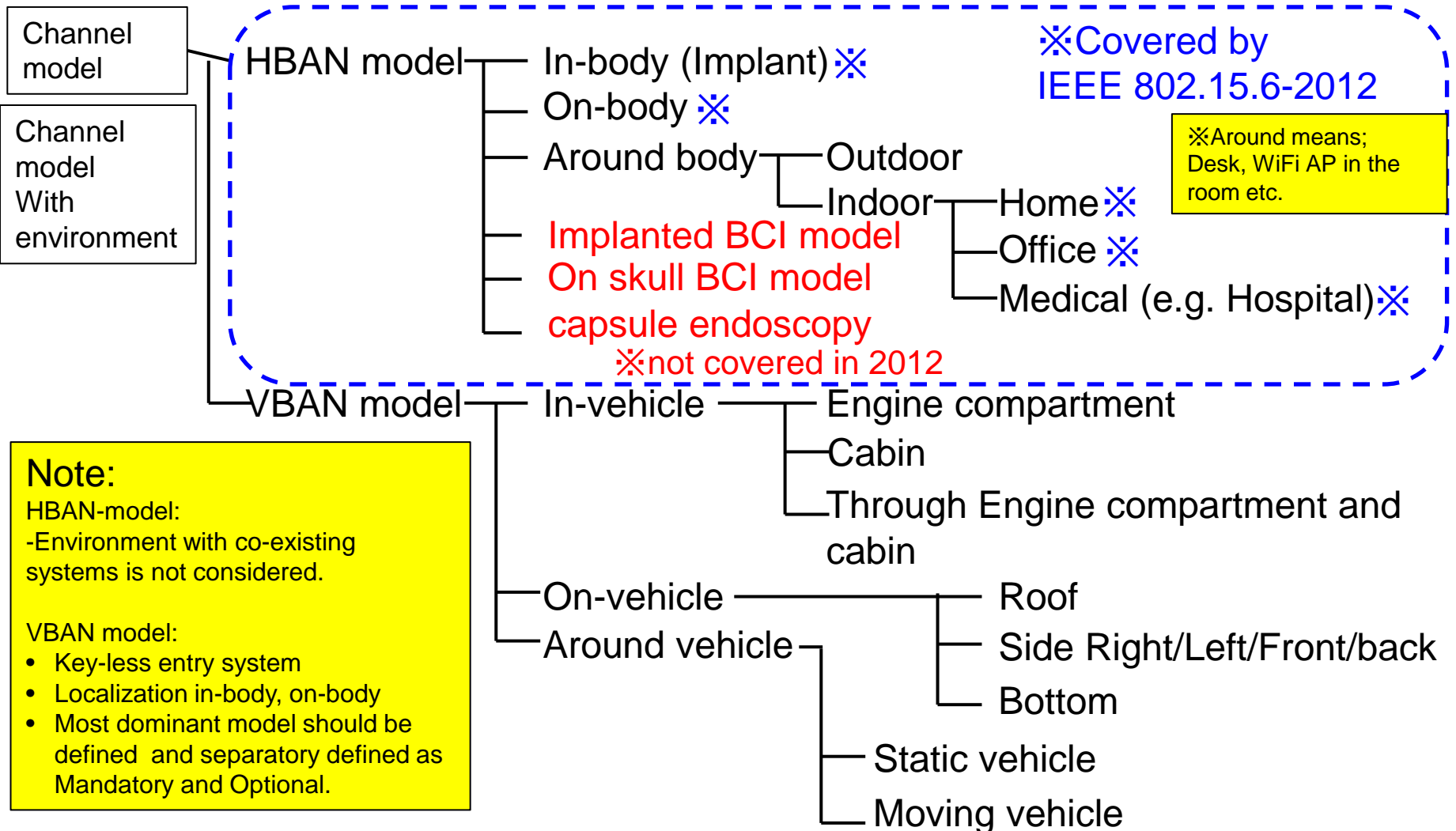

Agenda

1. Demand for WBAN for Emergent Medical Healthcare Use and Huge Market of Automotive Use and Expecting New Use Cases
2. Short Review of WBAN Standard IEEE802.15.6-2012
3. Necessity and Uniqueness for Revision of BAN with Enhanced Dependability
4. Channel and Environment Models for Focused Use Cases in Human and Vehicle BANs with Enhanced Dependability
5. Requirement for Revision of 15.6 MAC for Human and Vehicle BANs with Enhanced Dependability TG16.6ma
6. Core Technologies in PHY Layer for Enhanced Dependability TG16.6ma
7. Core Technologies in MAC Layer for Enhanced Dependability TG16.6ma
8. Letter Ballot210 and Timeline of TG6ma

5. Requirement for Revision of 15.6 MAC for Human and Vehicle BANs with Enhanced Dependability

TG15.6ma

5.1 Coexisting Models; Interference among BANs and other Networks

- There would be cases where BANs or BAN and other networks are spatially collapsed.

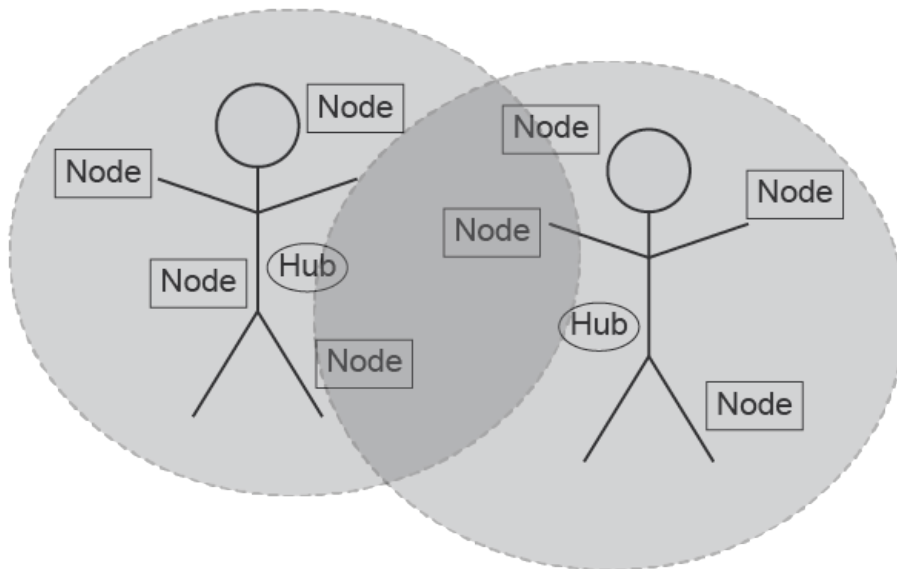

Case 1: BANs, using same frequency bands

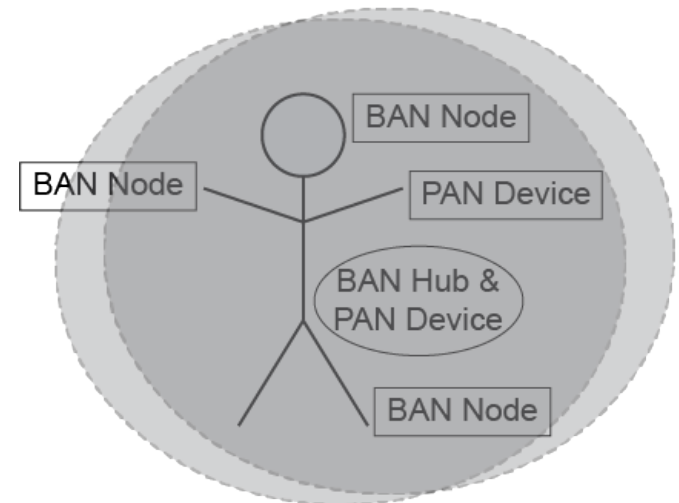

Case 2: BAN and PAN, using same frequency bands

5.2 Coexisting Models; Interference among BANs and other Radio Systems

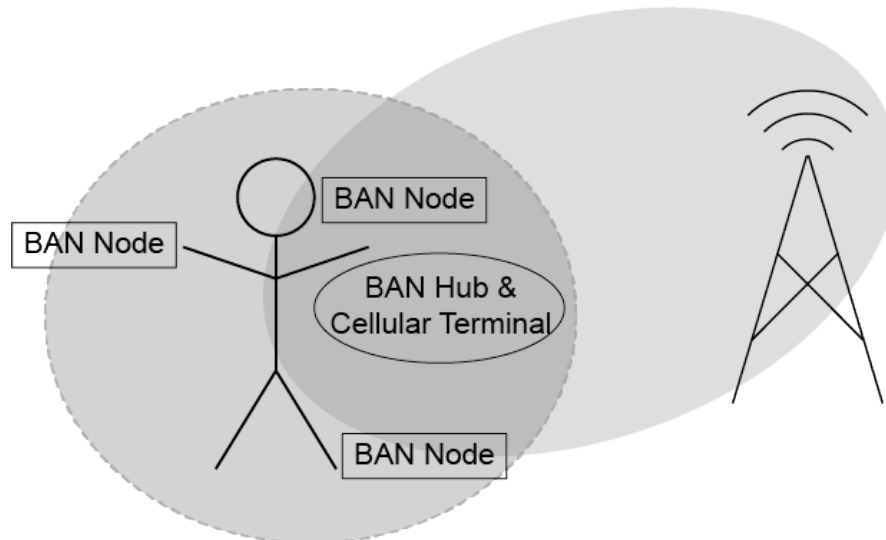

Case 3: BAN and other piconets such as cellular network or Wi-Fi, some part of their frequency bands are overlapped.

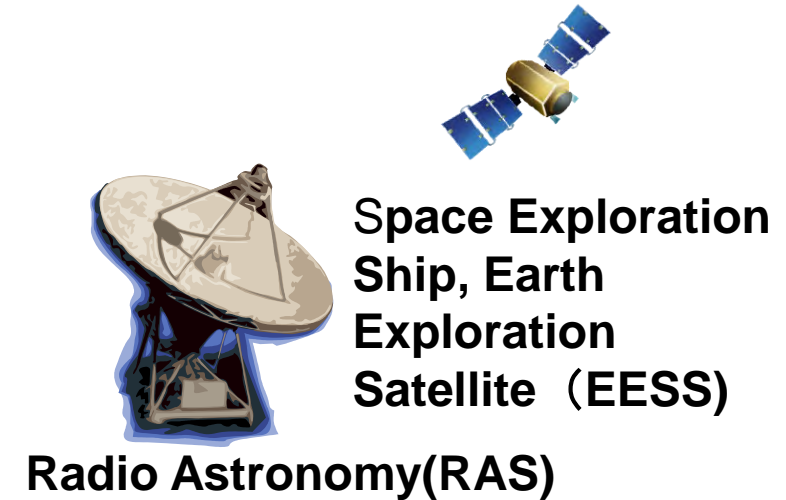

Case 4: **Coexisting Passive Radio Receiver Systems such as RAS, EESS etc.**

- **When introducing a new radio system, R&D of technologies to avoid interference among coexisting systems is mandatory by regulation and necessary in standard.**
- **Particularly, cognitive sensing, measuring, modelling, and interference mitigation technologies must be a common subject among URSI commissions.**

5.3 Definition of Coexistence Environment Classes

Coexistence Class	Coexisting system(s)					Category
	802.15.6ma	802.15.6-2012	Non-UWB (ex. Wi-Fi / Unlicensed / 3GPP)	802.15 UWB (ex. 802.15.4)	Non-802.15 UWB (ex. ETSI SmartBAN)	
0	-	-	-	-	-	Single BAN
1 (1a)	✓	-	-	-	-	Multiple 15.6 BANs
2 (1b)	✓	✓	-	-	-	
3	✓	-	✓	-	-	Non-UWB
4 (2a)	✓	-	-	✓	-	Multiple UWB systems
5 (2b)	✓	-	-	-	✓	
6 (2c)	✓	-	-	✓	✓	
7	✓	✓	✓	✓	✓	Final Boss

- The coexistence class has been redefined to 8 levels, which can be represented by 3 bits and would be suitable to include in PHY or MAC headers.

5.3.1 Coexistence Class States Transition(1/2)

- The standard's revision supports BANs operating with high reliability (coexistence class 0) and coexisting in dense environments with intra-interference and inter-interference (coexistence class 1 to 7). Figure 6 shows the state transition between several classes of coexistence environments defined in above – mentioned table.

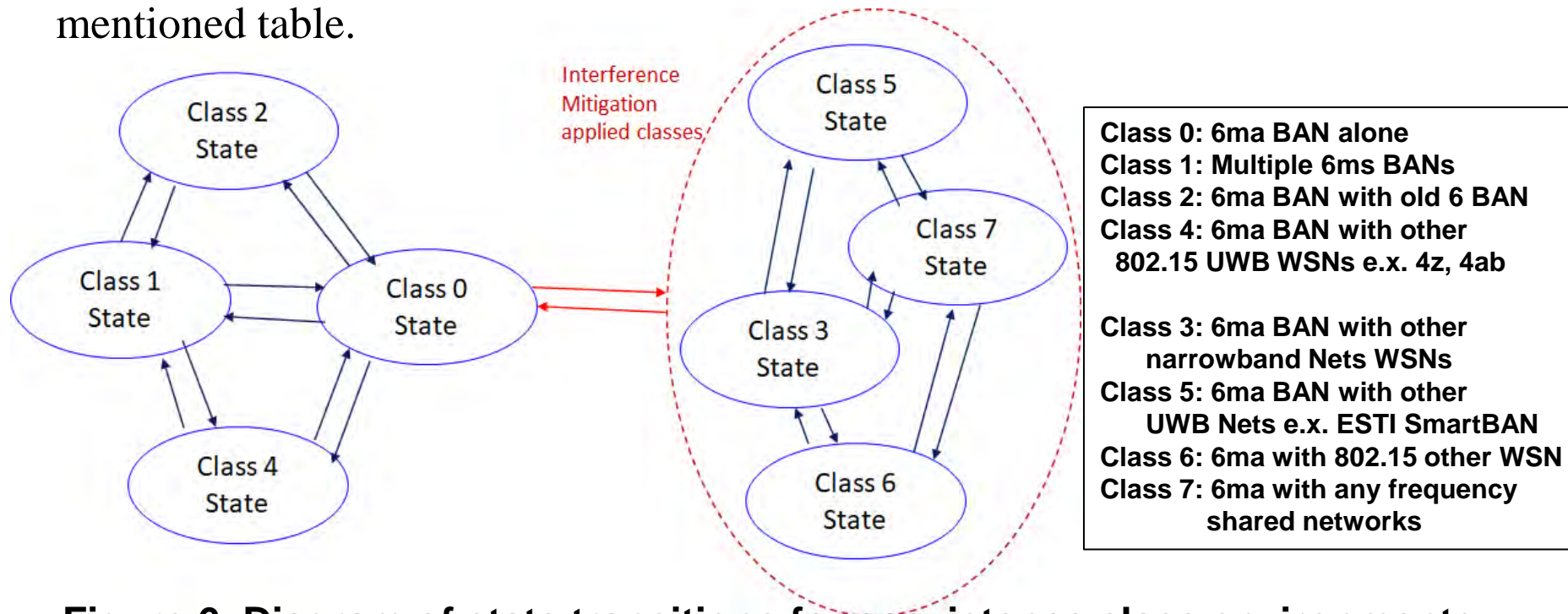

Figure 6 Diagram of state transitions for coexistence class environments.

5.3.2 Coexistence Class States Transition(2/2)

- The standard's revision focuses on the dependability mechanisms for a single HBAN or VBAN (Class 0) and the scenario with multiple HBANs or VBANS (Class 1).
- Class 2 supports compatibility with legacy BANs (IEEE 802.15.6-2012 Std).
- Class 4 supports coexistence with other IEEE 802.15 UWB Stds, and amendments such as 15.4, 15.8, 15.4z, and 4ab, via the PHY and MAC specification.
- **Classes 3, 5, 6, and 7 support coexistence with other wireless systems can result in Class 0, 1, and 2 by mitigation technology to cancel interference from other radios except legacy 15.6 at the receiver side (see clause 4.7.2 of draft#1.11).**
- During CCA, a BAN coordinator may analyze the type of synchronization preamble detected from a 15.6ma, 15.6, or 15.4 system.
- In Figure 6, the state transition probabilities are approximated in consecutive superframes. Furthermore, the duration of the CAP and CFP are determined by statistics of various QoS level of packets in previous consecutive superframes for every coming superframe.
- The draft revision #1.11 supports BANs operating with high reliability in dense environments coexisting with intra-interference and inter-interference due to other wireless systems in the same frequency band. Figure 6 shows state transition among several classes of coexistence environment defined in Table 1.

6. Core Technologies in PHY Layer for Revision of std 15.6-2012 for Human and Vehicle BANs with Enhanced Dependability TG16.6ma

6.1 Interference Mitigation Technologies

(1) Intra and Inter System Interference among BAN and Other PANs

◆ *Inter-user interference*

- IR-UWB uses the same pulse as all users signal in the same standard.
- **Other users** signal and/or the **other network** signal would be interference.

◆ *Inter-system interference*

- Interference from the other wireless system using overlapped frequency band. ⇒ **Unknown**

* 802.11a (wi-fi) (5GHz) overlaps

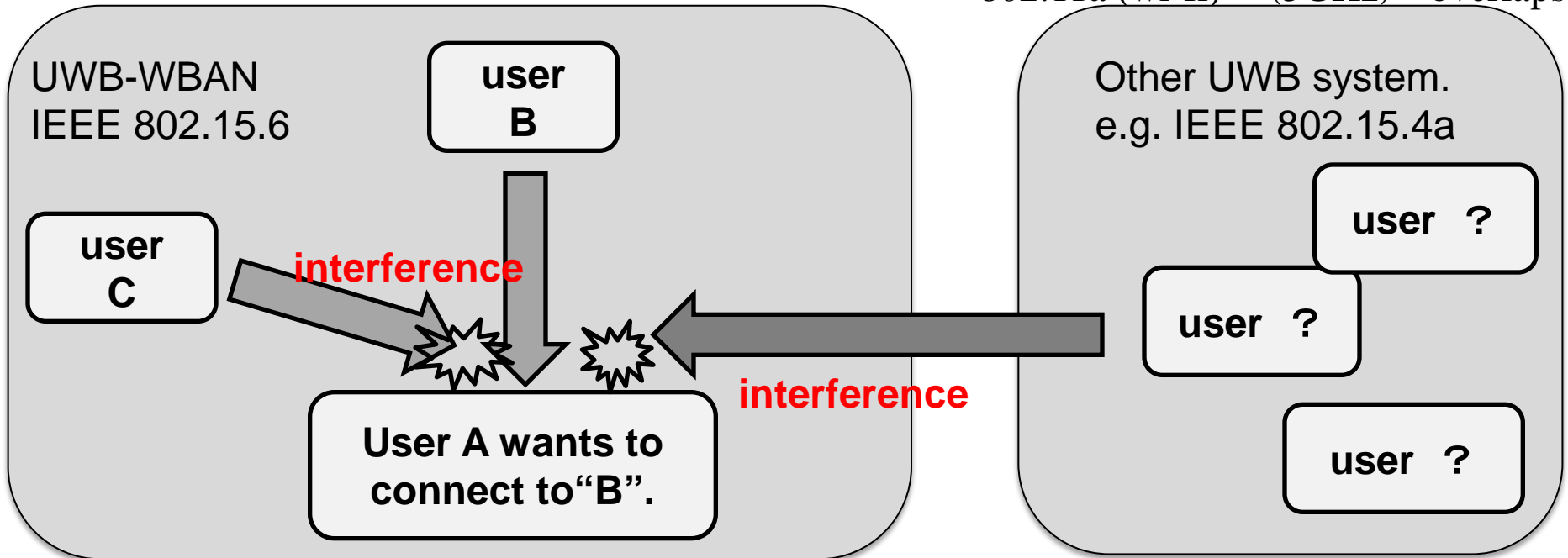

(2) Approach for Intra and Inter System Interference among BAN and Other PANs

- **Sparate** and **Recognize** each interference from different source.
 - * Apply suitable interference mitigation method according to source of interference.
- Using both of Spatial and Temporal signal processing.

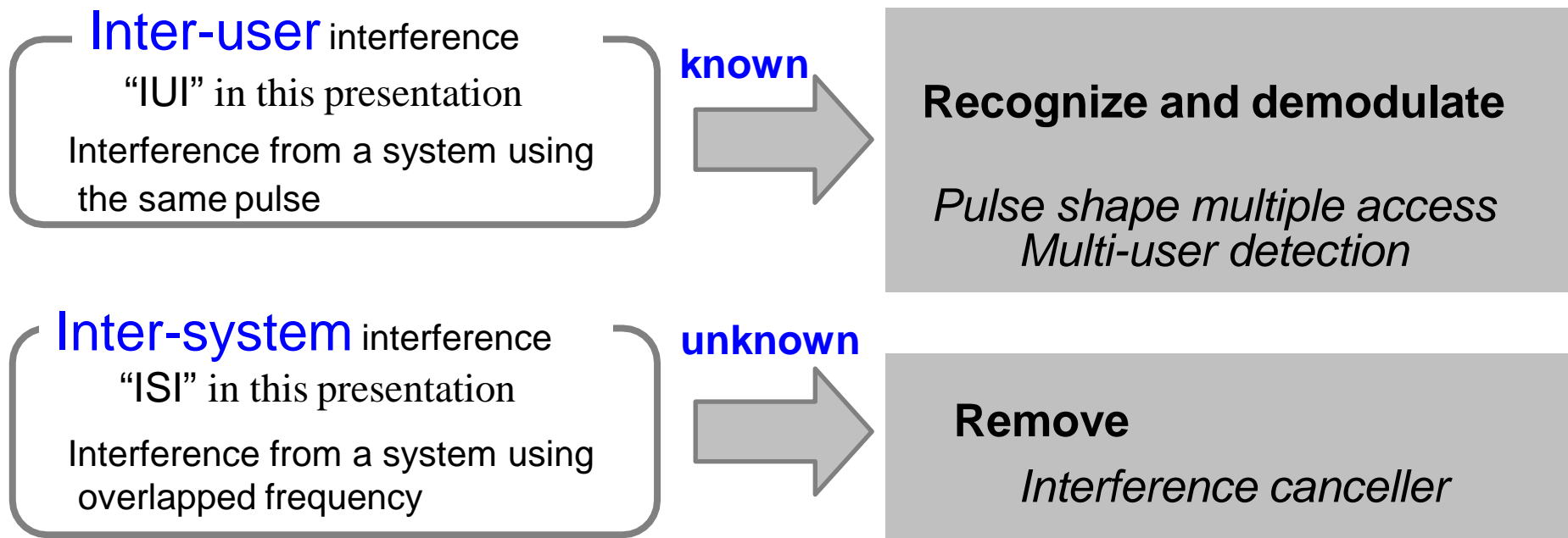

(3) Time Domain Interference Mitigation

● OMF ; orthogonal matched filter

- ◆ consists a matched filter (MF_1) and MF Group (MFG)
- ◆ Tap coefficients of MF_1 are the same as sequence of desired signal.
- ◆ Coefficients of MF_1 and each MF_k that constituting MFG are **orthogonal**.
- ◆ Desired signal does not through $MF_{2\sim K-1}$ because orthogonality.
→ **only interference can through.**
- ◆ **MFG makes replica of interference signal by lenear combination with weight vector w of linear combiner; LC.**
- ◆ Subtract interference replica from the output of MF_1 .

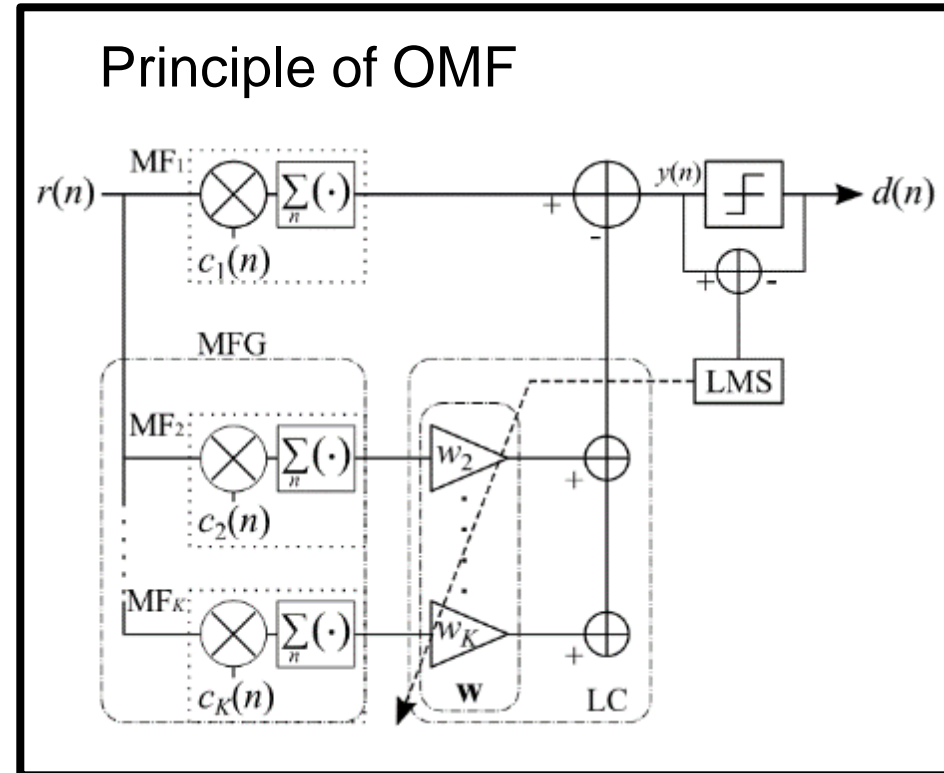

OMF can remove interference without any pre-knowledge of interference.

(4) Space Domain Interference Mitigation

● TDL-AA ; Tapped delay line array antenna

(Tapped delay line array antenna)

- ◆ Array antenna by using multiple antenna elements and tapped delay line.
- ◆ Each antenna branch has coefficients.
- ◆ Transfer function of this antenna has parameters of signal incoming **angle; θ** and **frequency; ω** .

⇒ has characteristics of both of spatial and time domain.

$$\tau_n = n \frac{d}{c} \sin \theta,$$

$$y(t) = \exp(j\omega t) \sum_{n=0}^{N-1} \sum_{m=0}^{M-1} \exp(-j\omega(\tau_n + mT_0)) w_{n,m},$$

$$= \exp(j\omega t) \times H(\theta, \omega),$$

$$H(\theta, \omega) = \sum_{n=0}^{N-1} \sum_{m=0}^{M-1} w_{n,m} \exp(-jm\omega T_0) \exp(-jn\omega \frac{d}{c} \sin \theta).$$

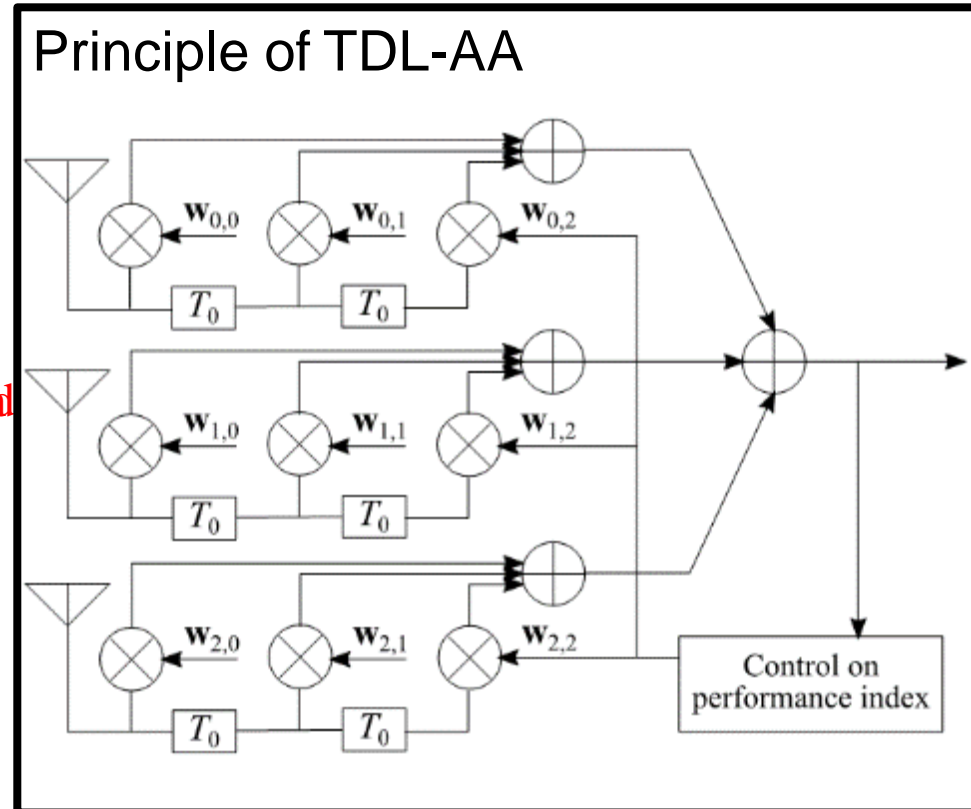

TDL-AA can work as interference canceller on both of time and space domains

(5) Interference Mitigation among Other Radios

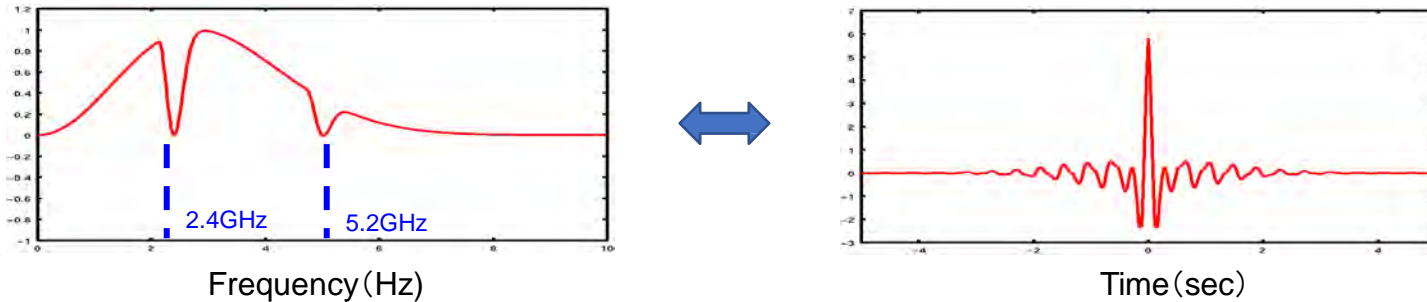

(a) Time Waveform of Pulse (right figure) and its Frequency Spectrum with notches in 2.4 and 5.2GHz for WLAN (left figure)

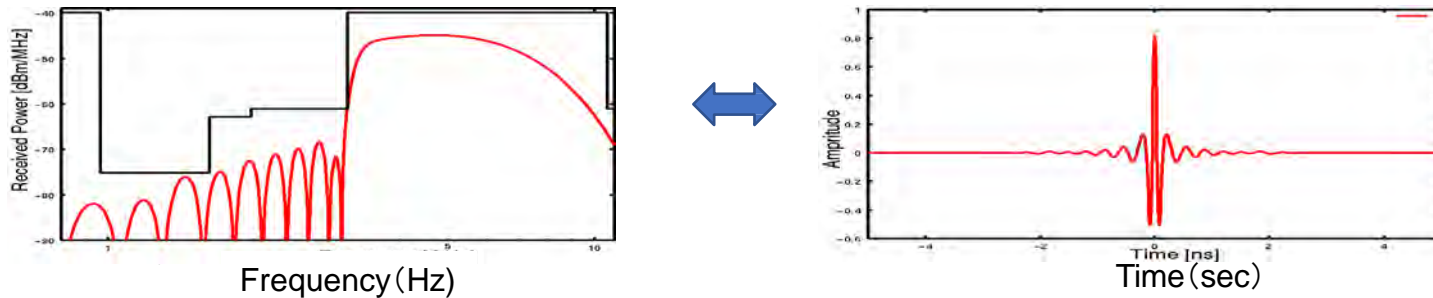

(b) Time Waveform of Pulse (right figure) and its Frequency Spectrum satisfying spectrum mask (left figure)

Ref. R.Kohno, H.Zhang, H.Nagasaka, "Ultra Wideband impulse radio using free-verse pulse waveform shaping , **Soft-Spectrum adaptation**, and local sine template receiving," doc.: IEEE 802.15-03/097r1, March 3, 2003.

(6) Integrated Terminal to Avoid Mutual Interference in case of overlaid coexisting BAN and other Radios such as UWB-BAN and 4G/5G

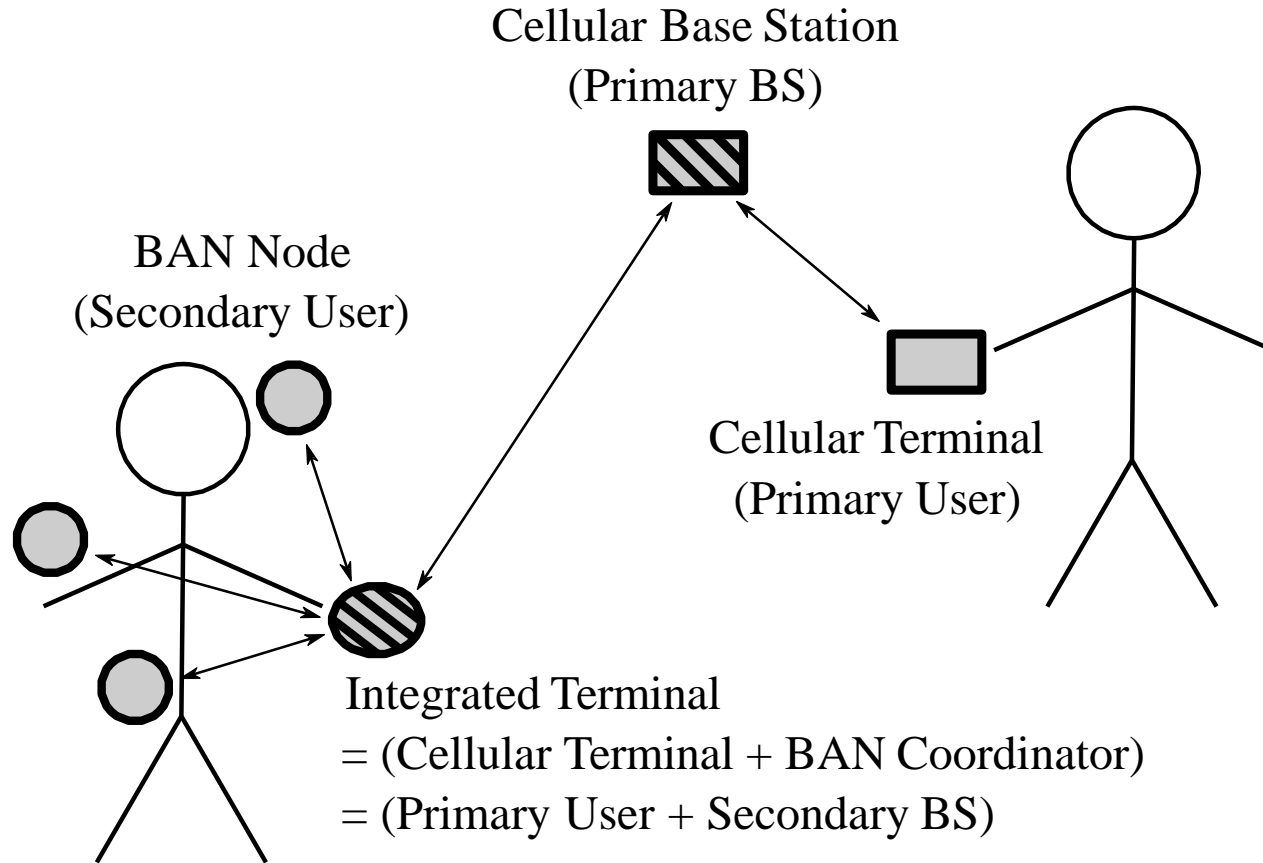

M. Kim, T. Kobayashi, C. Sugimoto, R. Kohno, "Transmission Power Control of UWB -WBAN for Avoidance of Interference to Cellular Networks Using Integrated Terminal for Both Networks," International Journal of Computer Science and Telecommunications, ISSN 2047-3338 (Online) , Vol. 11, Issue 02, pp.8-15, March 2020

6.2 Channel Coding

(1) QoS Levels of Packets corresponding to User Priority in IEEE802.15.6

- In Std.15.6 WBAN systems, a various data such as vital signs, skin temperature, blood pressure, ECG, EEG, ECoG, and vehicle controlling commons have different QoS levels corresponding to user priority.
- In 15.6ma for dependable WBAN for human and vehicles, data packet transmission should be dependable according to QoS levels even in various classes of coexistence environment.
- Therefore, **appropriate sets of error controlling scheme with FEC and hybrid ARQ** corresponding to QoS levels have been standardized in 15.6ma,

User priority	Traffic designation	Frame type
0	Background (BK)	Data
1	Best effort (BE)	Data
2	Excellent effort (EE)	Data
3	Video (VI)	Data
4	Voice (VO)	Data
5	Medical data or network control	Data or management
6	High-priority medical data or network control	Data or management
7	Emergency or medical implant event report	Data

(2) Channel Coding Table #1 for Class 0 and 1

Common with IEEE802.15.4ab

Error-correcting codes corresponding to QoS levels

User priority	Inner code	Outer code	HARQ
0	15.4ab LDPC or BCC (R=1/2)		-
1	15.4ab LDPC or BCC (R=1/2)		-
2	15.4ab LDPC or BCC (R=1/2)		-
3	15.4ab LDPC or BCC (R=1/2)		-
4	15.4ab LDPC or BCC (R=1/2)	(200,168) shortened RS code	-
5	15.4ab LDPC or BCC (R=1/2)	(200,168) shortened RS code	-
6	15.4ab LDPC or BCC (R=1/2)	(200,168) shortened RS code	-
7	15.4ab LDPC or BCC (R=1/2)	(200,168) shortened RS code	-

- As an outer code, shortened Reed-Solomon (RS) codes with N=200 (original code length N=255) will be selected to correct burst errors due to interference from other WBANs and the coding rates are changed according to each QoS and channel condition
- As an inner code, 15.4ab LDPC (K=324, 648, 972, R=1/2) or BCC will be selected for the coexistence of 15.6ma and 15.4ab
- This updated concept table is considered as the first priority

Common with IEEE802.15.4ab

(3) Channel Coding Table #2 for Class 2

User priority	Inner code	Outer code	HARQ
0	15.4ab LDPC or BCC (R=1/2)		-
1	15.4ab LDPC or BCC (R=1/2)		-
2	15.4ab LDPC or BCC (R=1/2)		-
3	15.4ab LDPC or BCC (R=1/2)		-
4			○
5			○
6			○
7			○

Hybrid ARQ (HARQ) for High QoS packets

- As an outer code, shortened Reed-Solomon (RS) codes with N=200 (original code length N=255) will be selected to correct burst errors due to interference from other WBANs and the coding rates are changed according to each QoS and channel condition
- As an inner code, 15.4ab LDPC (K=324, 648, 972, R=1/2) or BCC will be selected for the coexistence of 15.6ma and 15.4ab
- This updated concept table is considered as the first priority

(4) Channel Coding Table #3 for **Class 5**

Common with
IEEE802.15.4ab

Error-correcting codes
corresponding to QoS levels

User priority	Inner code	Outer code	HARQ
0	15.4ab LDPC or BCC (R=1/2)		-
1	15.4ab LDPC or BCC (R=1/2)		-
2	15.4ab LDPC or BCC (R=1/2)		-
3	15.4ab LDPC or BCC (R=1/2)		-
4	15.4ab LDPC or BCC (R=1/2)		-
5	15.4ab LDPC or BCC (R=1/2)	(200,168) shortened RS code	-
6	15.4ab LDPC or BCC (R=1/2)	(200,168) shortened RS code	-
7	15.4ab LDPC or BCC (R=1/2)	(200,168) shortened RS code	-

- As an outer code, shortened Reed-Solomon (RS) codes with $N=200$ (original code length $N=255$) will be selected to correct burst errors due to interference from other WBANs and the coding rates are changed according to each QoS and channel condition
- As an inner code, 15.4ab LDPC ($K=324, 648, 972, R=1/2$) or BCC will be selected for the coexistence of 15.6ma and 15.4ab
- This updated concept table is considered as the first priority

(5) Channel Coding Table #4 for Class 3, 4, 6 and 7

The same FEC for QoS levels 4,5,6 and 7 in Classes 0, 1, and 2

User priority	Inner code	Outer code	HARQ
0	15.4ab LDPC or BCC (R=1/2)	(200,168) shortened RS code	-
1	15.4ab LDPC or BCC (R=1/2)	(200,168) shortened RS code	-
2	15.4ab LDPC or BCC (R=1/2)	(200,168) shortened RS code	-
3	15.4ab LDPC or BCC (R=1/2)	(200,168) shortened RS code	-
4	15.4ab LDPC or BCC (R=1/2)	(200,168) shortened RS code	-
5			○
6			○
7			○

Hybrid ARQ (HARQ) for High QoS packets

- As an outer code, 15.4ab LDPC (K=324, 648, 972, R=1/2) codes will be selected for the coexistence of 15.6ma and 15.4ab
- As an inner code, 15.4a/z based convolutional codes (which are almost the same of our proposed decomposable codes) will be selected, and the coding rates are changed according to each QoS and channel condition, which can be applied to hybrid ARQ
- This table is considered as the second choice

(6) Specification of Error-Control Defined Corresponding Combination of 8 QoS Levels and 8 Coexistence Classes

Coexistence Class	0	1	2	3	4	5	6	7
QoS Level								
0	LDPC/BCC	LDPC/BCC	LDPC/BCC	LDPC/RS	LDPC/RS	LDPC/BCC	LDPC/RS	LDPC/RS
1	LDPC/BCC	LDPC/BCC	LDPC/BCC	LDPC/RS	LDPC/RS	LDPC/BCC	LDPC/RS	LDPC/RS
2	LDPC/BCC	LDPC/BCC	LDPC/BCC	LDPS/RS	LDPS/RS	LDPC/BCC	LDPS/RS	LDPS/RS
3	LDPS/BCC	LDPS/BCC	LDPS/BCC	LDPS/RS	LDPS/RS	LDPS/BCC	LDPS/RS	LDPS/RS
4	LDPC/RS	LDPC/RS	CFP/HARQ	LDPC/RS	LDPC/RS	LDPS/BCC	LDPC/RS	LDPC/RS
5	LDPC/RS	LDPC/RS	CFP/HARQ	CFP/HARQ	CFP/HARQ	LDPC/RS	CFP/HARQ	CFP/HARQ
6	LDPS/RS	LDPS/RS	CFP/HARQ	CFP/HARQ	CFP/HARQ	LDPS/RS	CFP/HARQ	CFP/HARQ
7	LDPS/RS	LDPS/RS	CFP/HARQ	CFP/HARQ	CFP/HARQ	LDPS/RS	CFP/HARQ	CFP/HARQ

(7) Evaluation of Channel Codes Assigned Corresponding to Different QoS Priority Levels

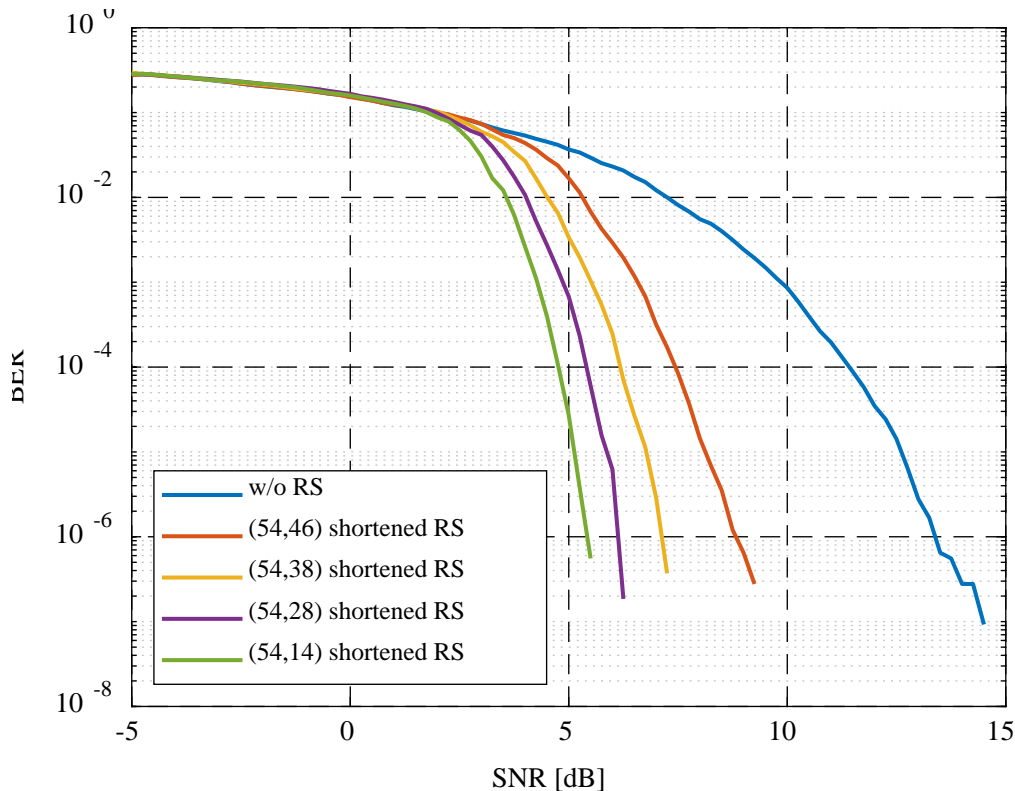

Bit error ratio of (54,46), (54,38), (54,28), (54,14) shortened RS codes and no encoding were evaluated under an AWGN channel and BPSK modulation

Performances were improved as the coding rate decreased

LDPC simulator is currently checked and will be combined with the RS simulator

(8) Performance Evaluation of Channel Coding with Interleaver

- Concatenated code
 - Outer code : Two shortened RS codes
 - Inner code : LDPC code
- BPSK modulated

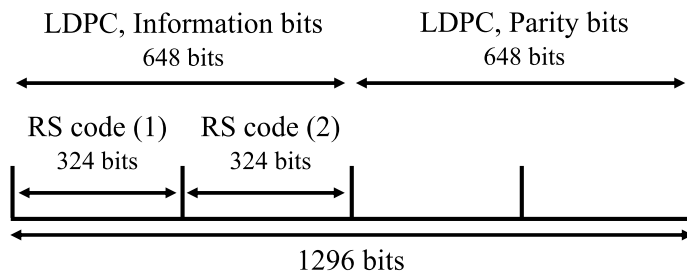

Configuration of concatenated code

- Shortened RS code
 - 1 symbol = 6 bits
 - Codeword : 63 symbols
 - Shortened symbol : 9 symbols
 - Code length : $(63 - 9) \times 6 = 324$ bits
 - Coding rate : 46/54, 38/54, 28/54, 14/54
- LDPC code
 - Code length : 1296 bits
 - Coding rate : 1/2
 - Number of iteration : 30
 - Decoding algorithm : Min-sum algorithm

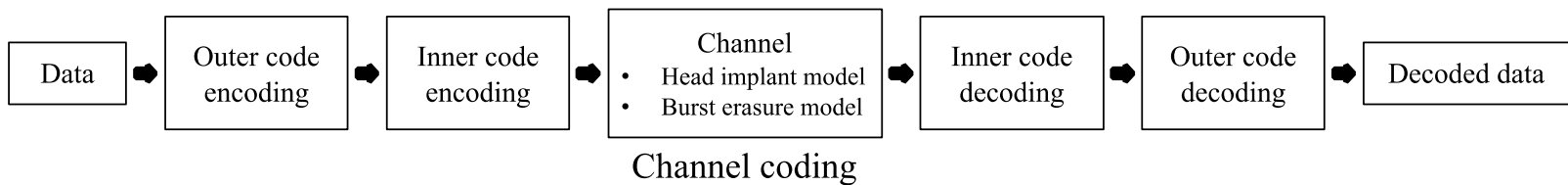

(9) Effect of interleaving on BER performance

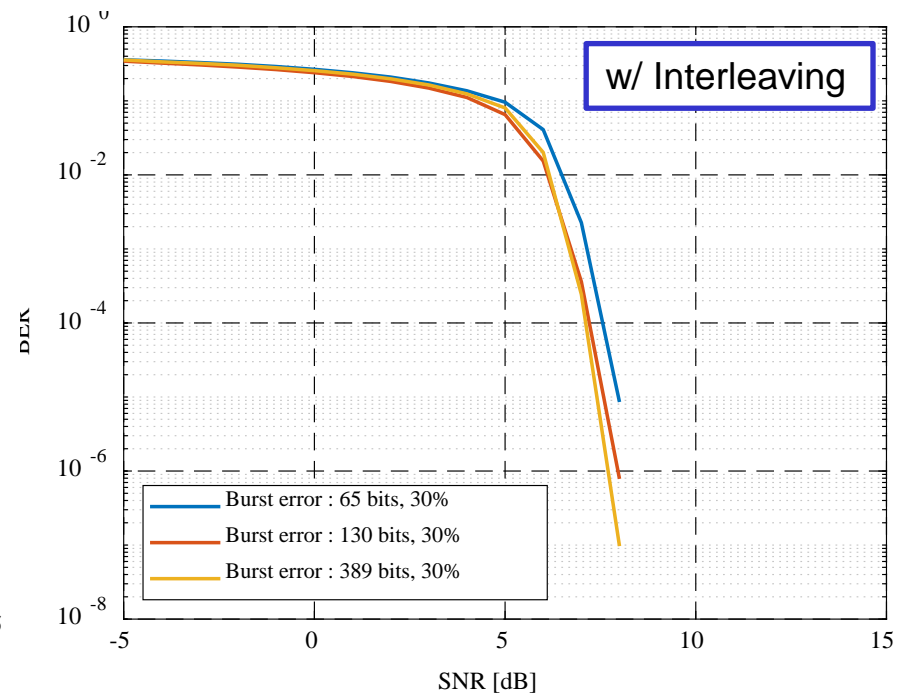
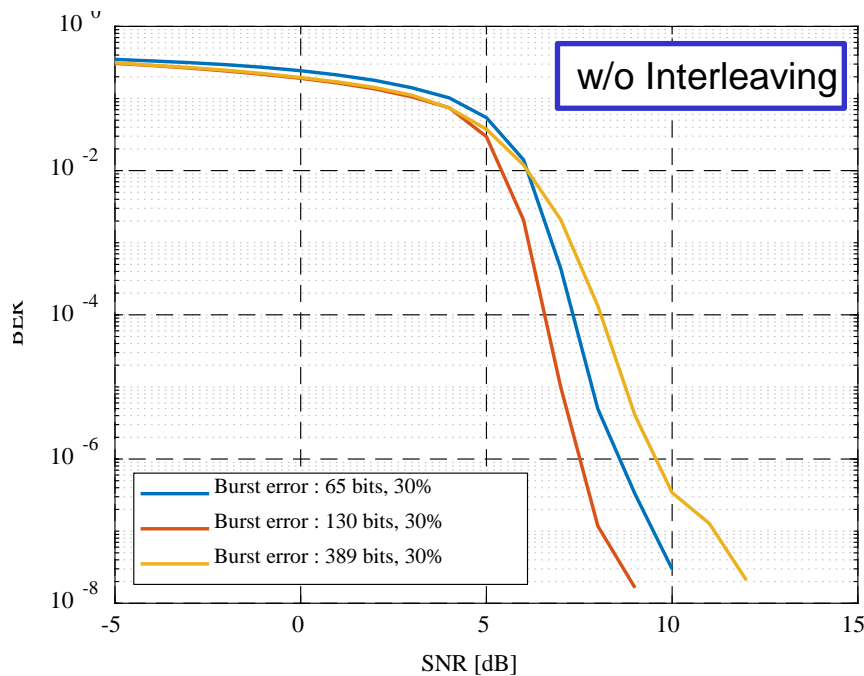

- Modulation: BPSK
- Interleaver type: Random
- Channel: AWGN + burst erasure channel

(10) Effect of interleaving on BER performance

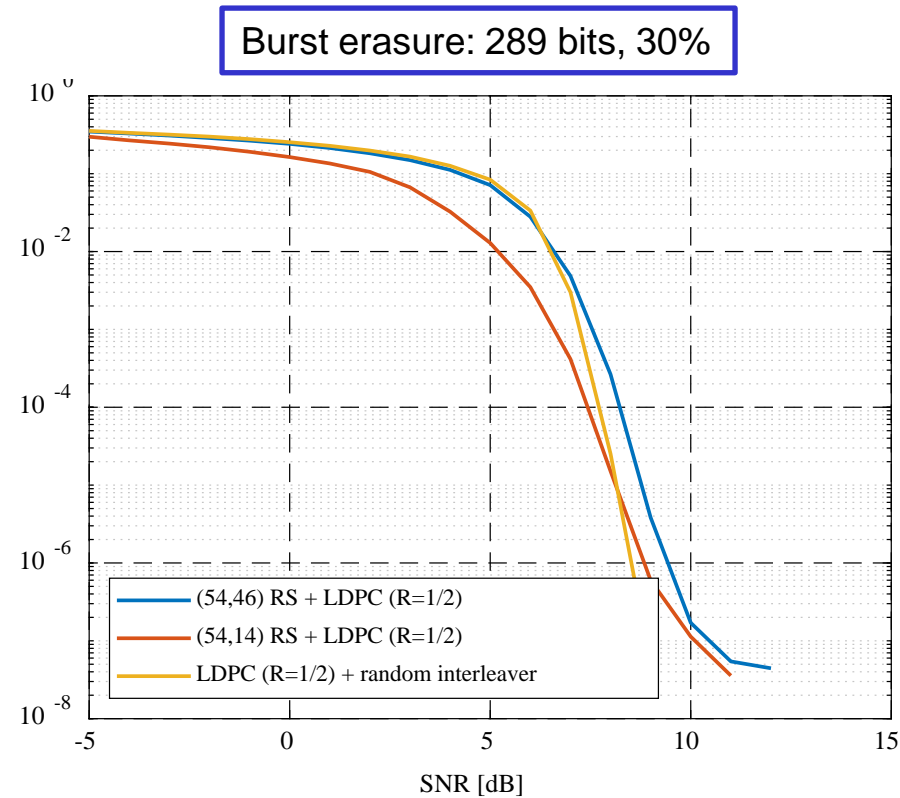
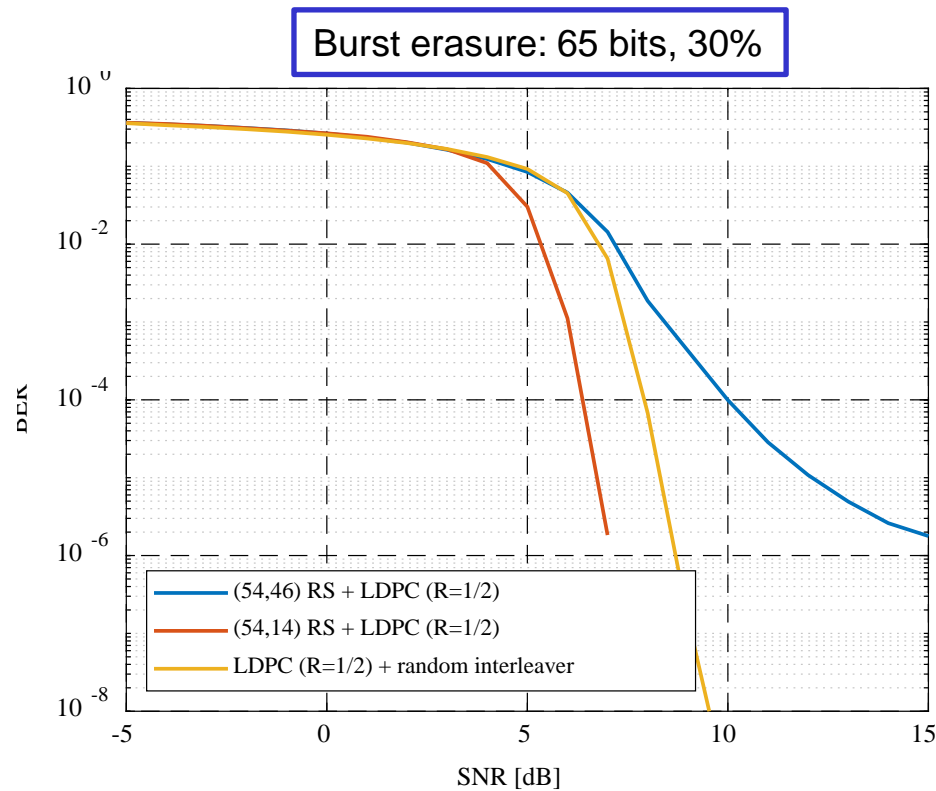

- Modulation: BPSK
- Interleaver type: Random
- Channel: AWGN + burst erasure channel

(11) Effect of interleaving on BER performance

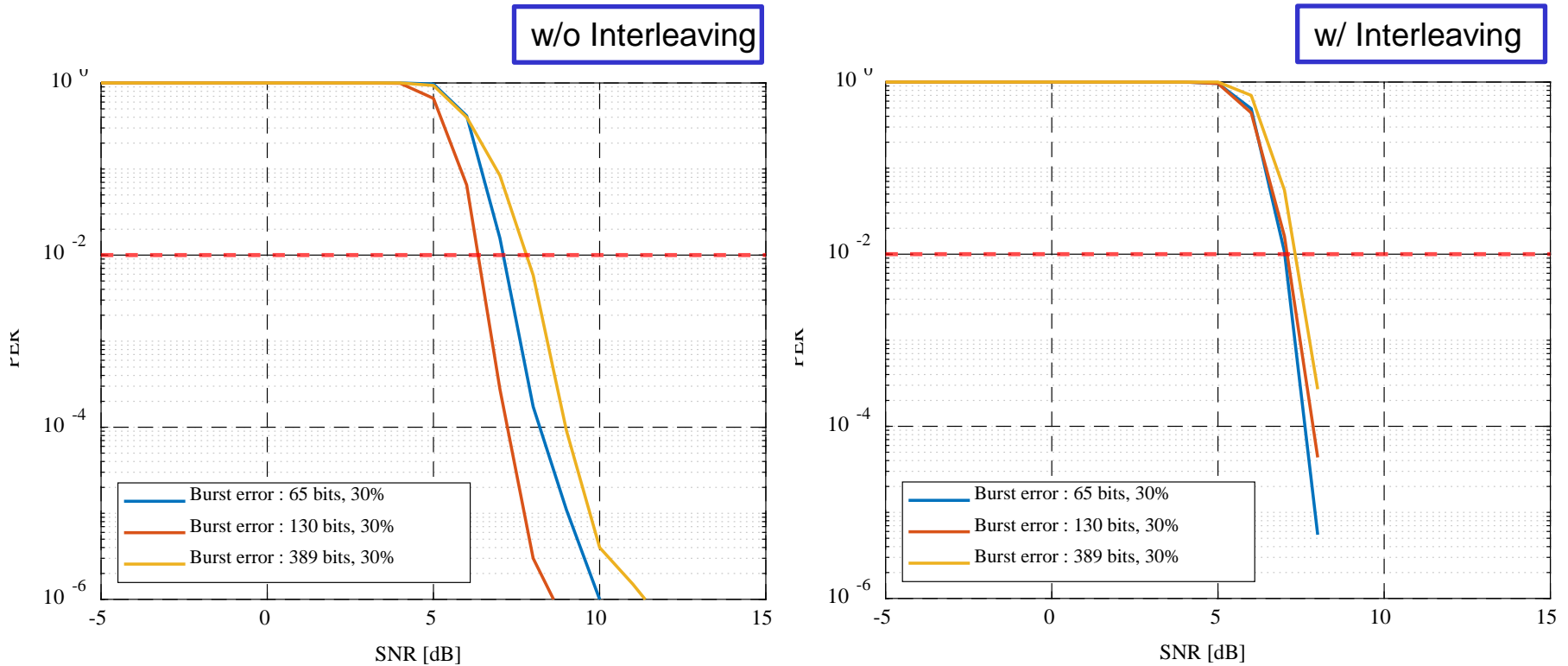

- Modulation: BPSK
- RS(54, 28) + LDPC(R=1/2)
- Channel: AWGN + burst erasure channel

7. Core Technologies in MAC Layer of IEEE802.15.6ma for Revision of std 15.6-2012 for Human and Vehicle BANs with Enhanced Dependability TG16.6ma

7.1 MAC Basic Consensus

- Two channels using two UWB band channels are applied for control channel to control frames of coexisting networks and data transmission channel. **Its alternative mode is two channels or time slots for control and data transmission using a single UWB band channel.**
- IEEE802.15.6ma; revision of IEEE802.15.6-2012 focuses on enhanced dependability in data transmission and ranging according to the class 0-7 of coexistence.
 1. **Class 0&1:** New 15.6ma MAC is defined primarily to support enhanced dependability of a new 15.6ma BAN (Class 0) and multiple 15.6ma BANs (Class 1).
 2. **Class 2:** 15,6ma MAC is defined secondarily to support backward compatibility with a legacy 15.6-2012 BAN as long as enhanced dependability of a new 15.6ma BAN can be performed in Class 2.
 3. **Class 4:** 15.6ma MAC is defined to support interoperability with coexisting 15.4ab WSN/PAN in secondary as long as enhanced dependability of 15.6ma BAN can be performed in primary in Class 4.
 4. **Class 3,5,6,7:** 15.6ma MAC is defined to support enhanced dependability of 15.6ma BAN while mitigating interference from coexisting other radios.
- **Hence, new 15.6ma MAC documentation must be good enough by describing mostly in Class 1 including Class 0, and Class 4 while describing a way to recognize class of coexistence and to mitigate interference in other classes.**

7.2 MAC Frame Structure

7.2.1. MSDU format in 15.6-2012

- The usual: MAC header + MAC payload + MAC footer

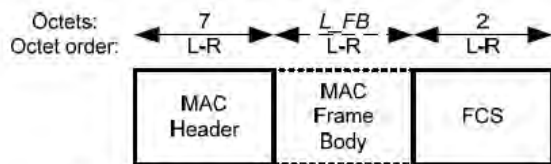

Figure 8—MAC frame format

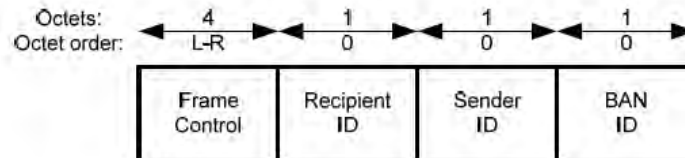

Figure 9—MAC Header format

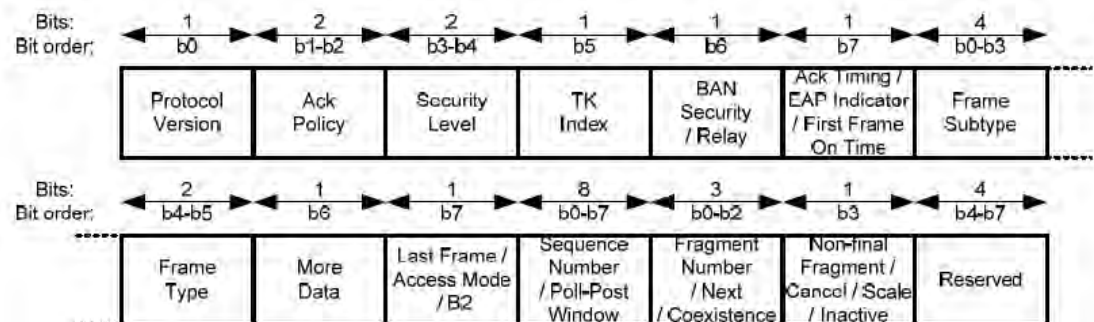

Figure 10—Frame Control format

7.2.2 15.6ma MAC

- Due to the historic background of 15.6, the MSDU format supports several MAC mechanisms (polling, CSMA, slotted Aloha, LBT), and it is up to vendors what specifically to implement.
 - However, the result was that the MAC spec is difficult to understand
- The revision 15.6ma plans to simplify the MAC mechanism under a UWB PHY:
 - LBT & slotted Aloha (CAP) and TDMA (CFP)
 - (maybe the support of an Ethertype field)
 - Hence, the MSDU Header will change.

7.2.3 MAC Protocol for Multiple BAN Environment (Class 1) # 15-22-0639 & 15-22-651-01

1.Utilizes Control Channel.

- Limits transmission privilege on Control Channel only to coordinators.
- Allows more efficient and accurate clear channel assessment by separating control frames and data frames.
- Two mandatory channels for control and data frames are required.

2.Introduces 3 Periods in Data Channel

- Network Management Period (**NMP**) for Data Beacons,
- Contention Free Period (**CFP**) for scheduled data frames,
- And Contention Access Period (**CAP**) for unscheduled data frames and node connection/disconnection.

3.Each BAN has its own contention free period while sharing superframes.

- To avoid frame collision between coexisting BANs.
- Operating procedures of some MAC functions such as BAN Creation and Superframe Transition are explained.
- The newly required fields for performing this procedure have been explained.

7.2.4 MAC in Class 1 for coexisting dependable BANs # 15-22-0594 & 15-22-651-01(January 2023)

1. Dependable BAN Service Classes

- Specifies three classes. Coexisting BANs will coordinates based on the BAN class.

2. Beacon Period Extension

- Allows flexible configuration of the beacon period.
- Supports large number of nodes while guaranteeing short cycle time.
- Guarantees that nodes can access the channel every cycle time.

3. Coordinator Hub and Beacon Access Phase

- Defines Beacon Access Phase (**BAP**) in the beacon period.
- Defines a coordinator hub and a leaf hub and let coordinator hub assigns beacon slots for leaf hubs.

4. Scheduled Access Extension

- Allows nodes have periodic access multiple times in a beacon period

5. Adaptive Superframe Interleaving with Adjustment and Regulation

- Negotiates the structure of beacon period among coexisting dependable BANs and regulates transmissions.

7.3 MAC Function

7.3.1 MAC Mode 1

Two UWB Bands Use for Control and Data Transmission Channels for Enhanced Dependability

According to functionality of used RF devices and modules, the following two modes of MAC function can be chosen. Primarily mode 1 is recommended for highly enhanced dependability if RF devices and modules can use two UWB bands channels while mode 2 is alternative choice if only a single UWB band channel is available.

- **MAC Mode 1:** Two channels using two UWB band channels are applied for control channel to manage frames of coexisting networks and data transmission channel.
- **MAC Mode 2:** Another alternative mode is two channels in time slots for control and data transmission using a single UWB band channel.

(1) Channel configuration

Band group	Channel number	Central frequency (MHz)	Bandwidth (MHz)	Channel attribute in 802.15.6-2012	Channel attribute for the revision	
Low band	0	3494.4	499.2	Optional	Control	Optional
	1	3993.6	499.2	Mandatory	Control/Data	Mandatory
	2	4492.8	499.2	Optional		Optional
High band	3	6489.6	499.2	Optional	Control/Data	Optional
	4	6988.8	499.2	Optional		Optional
	5	7488.0	499.2	Optional	Control	Optional
	6	7987.2	499.2	Mandatory	Control/Data	Mandatory
	7	8486.4	499.2	Optional		Optional
	8	8985.6	499.2	Optional		Optional
	9	9484.8	499.2	Optional		Optional
	10	9984.0	499.2	Optional		Optional

- In the original IEEE Std 802.15.6-2012, one specific channel is designated as mandatory for each band group.
- To maintain backward compatibility with the original standard, the mandatory channel configuration remains unchanged in the proposed revision.
- Additionally, in the proposed revision, one channel is designated as the control channel, which can be utilized as a common channel shared by multiple systems.

(2) Frame assignments for Control/Data Channels

Channel s	Periods	Frames (draft)	
		From coordinators	From nodes
Control	n/a	<ul style="list-style-type: none"> Control Beacon Coordinator-to-coordinator 	Not allowed
Data	Network Management	<ul style="list-style-type: none"> Data Beacon 	
	Contention Free	<ul style="list-style-type: none"> Scheduled Data 	<ul style="list-style-type: none"> Scheduled Data
	Contention Access	<ul style="list-style-type: none"> Connection Assignment Disconnection Response Unscheduled Data 	<ul style="list-style-type: none"> Connection Request Disconnection Notification Unscheduled Data

The frame assignments have been developed to account for hardware limitations between the coordinator and the nodes, including processing power, transmitting power, memory capacity, and energy efficiency.

(3) Control Channel

- Only coordinators are allowed to transmit on the control channel (C-Channel).
- The control channel does not follow a time slot structure.
 - Due to the mobility of BANs, there is a possibility that BANs or groups of BANs with different synchronization timings may come across each other.
 - Therefore, it is reasonable to design MAC protocol with the assumption that reliable synchronization between multiple BANS is not possible.
 - This is particularly important when considering the interoperability of BANs with other UWB systems.

(3) Control Channel (cont.)

- A coordinator is required to transmit a control beacon frame (C-Beacon) on the control channel (C-Channel) at regular intervals of T_C seconds.
 - Prior to emitting the first C-Beacon, the coordinator must perform Clear Channel Assessment (CCA) to ensure the channel is clear.
 - The C-Beacon Period, T_C , is randomly selected by the coordinator within the range of $T_{C,\min}$ to $T_{C,\max}$.

(4) Why is the C-Beacon Period Random?

- When all coordinators transmit their C-Beacons at the same interval, a collision between C-Beacons will persist indefinitely, causing ongoing interference.
- However, by assigning each coordinator a different interval, collisions can be minimized or eliminated.
- It is desirable to choose intervals that are relatively prime or have a large greatest common multiple, as this reduces the likelihood of future collisions and enhances overall network performance.

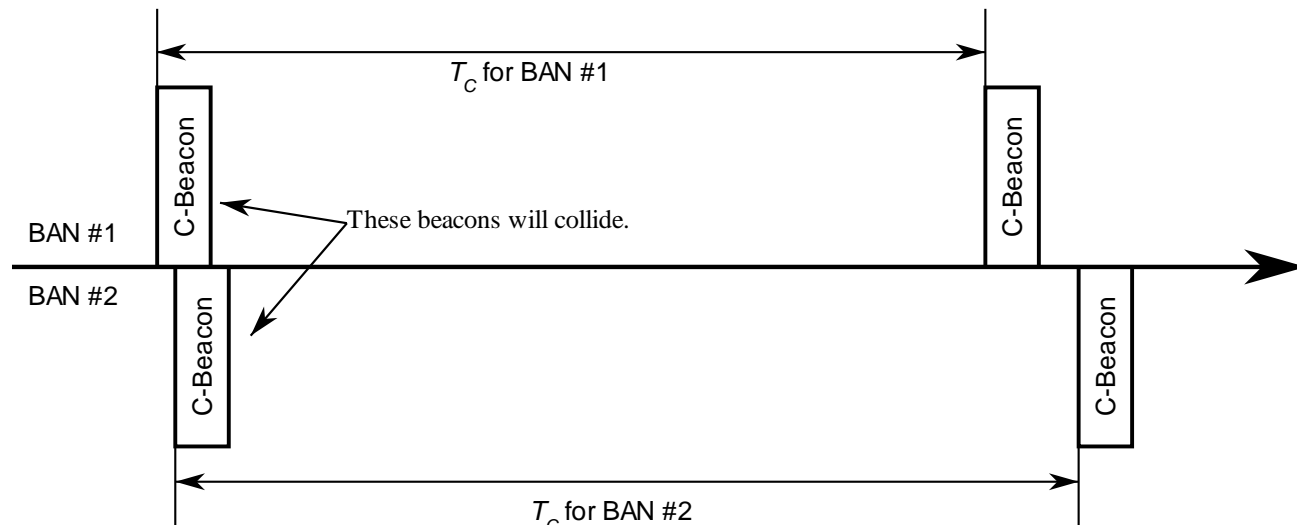

(5) Data Channel

- Both coordinators and nodes have the capability to transmit on the data channel (D-Channel).
- The time axis in a D-Channel is divided into superframes, each with a fixed duration of T_D seconds.
- Within each superframe, the time axis is further divided into time slots, each with a fixed duration of T_S seconds.
- The superframe consist of four distinct periods:
 - Network Management Period (NMP): This period consist of N_{NMP} time slots, which are dedicated to transmitting network management frames, such as data beacons.
 - Contention Free Period (CFP): This period consist of N_{CFP} time slots, which are reserved for transmitting scheduled frames.
 - Contention Access Period (CAP): This period consist of N_{CAP} time slots, which are used for transmitting unscheduled frames.
 - Inactive Period: During this period, no frames are transmitted.

(5) Data Channel (cont.)

- Each coordinator is required to select one D-Channel.
- To achieve higher dependability, a coordinator may support the use of multiple D-Channels simultaneously.
- Within each superframe of the selected D-Channel, a coordinator transmits a data beacon frame (D-Beacon) on a single time slot from the Network Management Period (NMP).

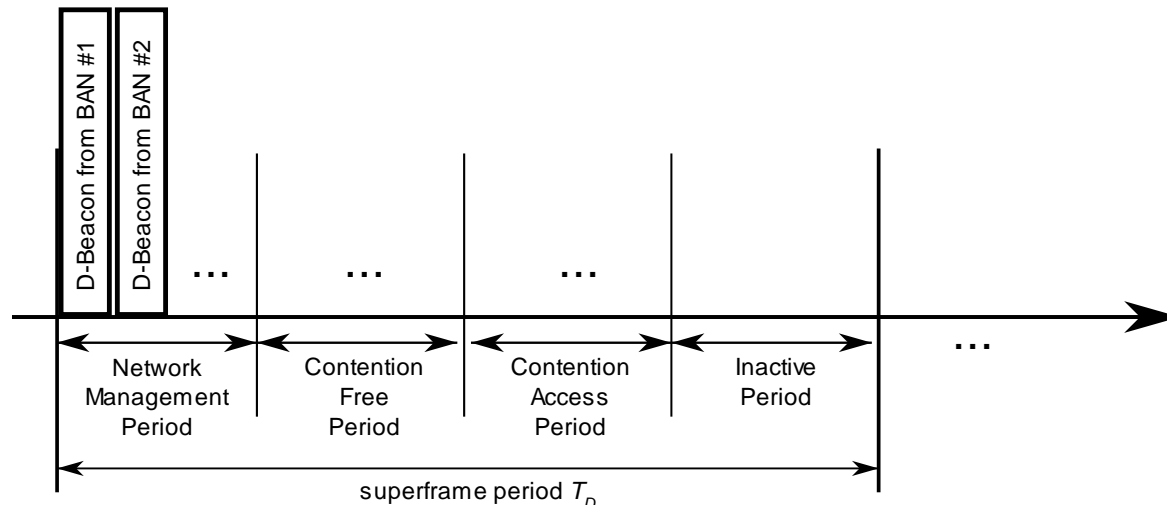

(6) MAC Functions

- BAN Creation
- Superframe transition due to proximity of BAN piconets
- Node Connection/Disconnection
- Channel access
 - Contention Free Period – TDMA
 - Contention Access Period – Slotted aloha

(7) BAN Creation

- **Neighbor BAN Detection:** The coordinator monitors the C-Channel to identify neighboring BANs and determine their presence.
- **BAN ID Selection:** The coordinator selects an available BAN ID that is not currently in use by neighboring BANs to ensure uniqueness within the network.
- **Data Channel (D-Channel) Selection:** The coordinator chooses a suitable D-Channel for communication. D-Channel Occupancy Indexes obtained from neighboring BAN's C-Beacons can be used to determine which D-Channel to use.
- **D-Channel Synchronization:** If other BANs are using the same D-Channel, the coordinator synchronizes to the superframe of the BAN(s) already using that D-Channel.

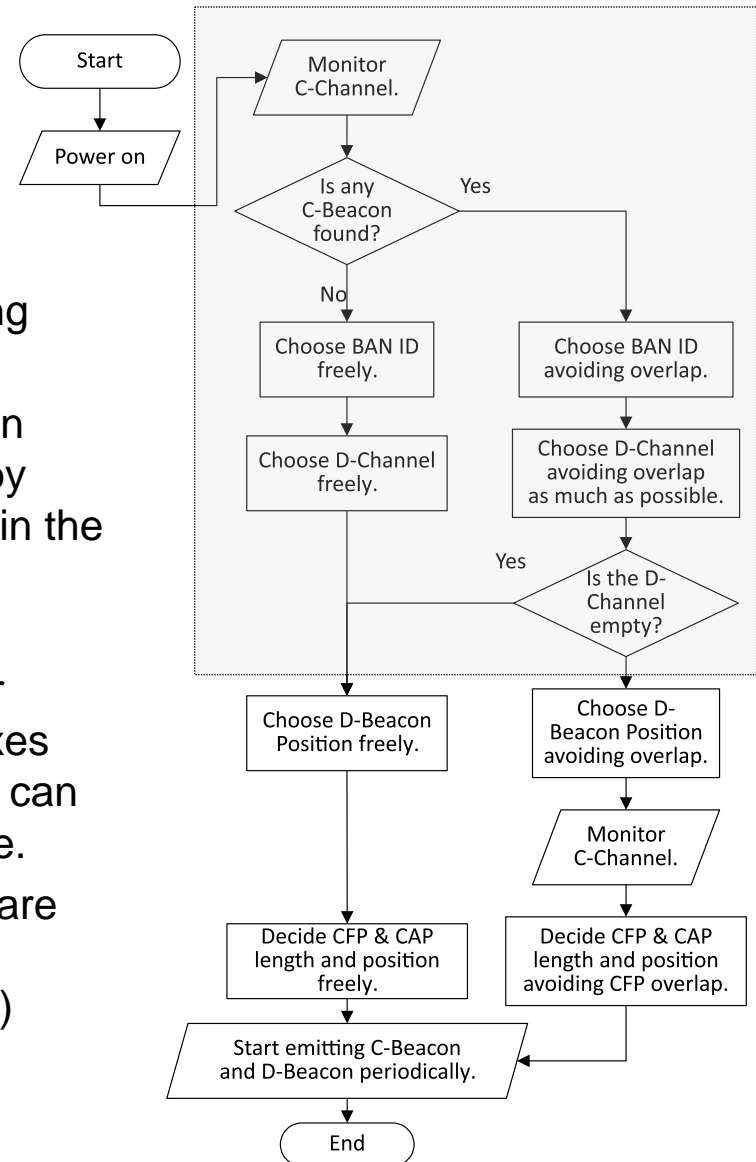

(7) BAN Creation (cont.)

- D-Beacon Position Selection:** The coordinator selects a specific position for the D-Beacon transmission within the Network Management Period (NMP) of the superframe. It ensures that the chosen position does not overlap with neighboring BANs using the same D-Channel.
- Periodic Control Beacon (C-Beacon) Transmission:** The coordinator transmits Control Beacons periodically on the C-Channel. The C-Beacon includes essential information such as the BAN ID, D-Channel number, and D-Beacon Position in NMP.
- Periodic Data Beacon (D-Beacon) Transmission:** The coordinator transmits Data Beacons periodically on the D-Channel. The D-Beacon provides slot numbers indicating the start of the Contention Free Period (CFP) and the Contention Access Period (CAP) within each superframe.

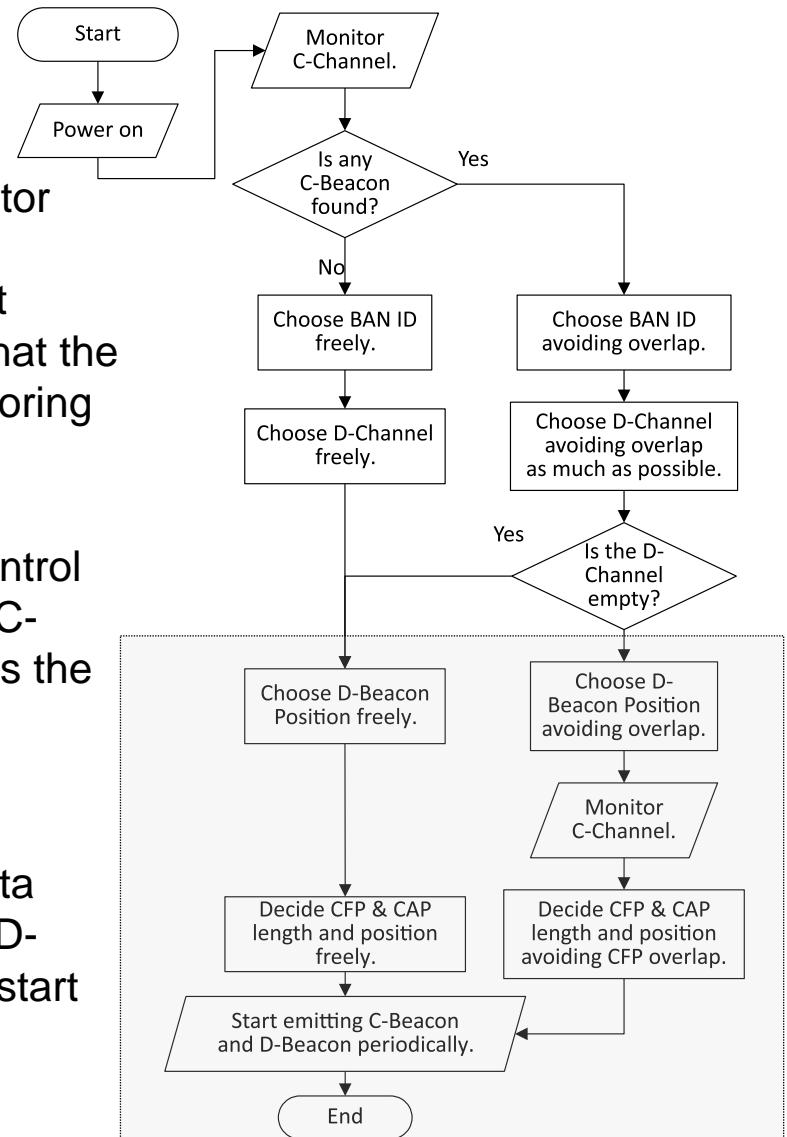

(8) List of Frame Type

Channels	Periods	Frames	Sender	Receiver
Control	n/a	Control Beacon	Coordinator	Other Coordinators and Nodes
		Coordinator-to-Coordinator		Other Coordinators
Data	Network Management	Data Beacon	Coordinator	Other Coordinators and Nodes
	Contention Free	Scheduled Downlink Data	Coordinator	Specific Node
			Coordinator	Relay Node
			Relay Node	Relay Node
			Relay Node	Specific Node
			Node	Own Coordinator
			Node	Relay Node
			Relay Node	Relay Node
			Relay Node	Own Coordinator
	Contention Access	Connection Request	Node	Own Coordinator
		Connection Assignment	Coordinator	Specific Node
		Disconnection Notification	Node	Own Coordinator
		Unscheduled Uplink Data	Specific Node	Own Coordinator

7.3 MAC Function

7.3.2 MAC Mode 2

Two Channels in Time Slots for Control and Data Transmission Using a Single UWB Band Channel.

MAC Mode 1: Two channels in frequency bands using two UWB band channels are applied for control channel to manage frames of coexisting networks and data transmission channel.

MAC Mode 2: Another alternative mode is two channels in time slots for control and data transmission using a single UWB band channel.

(1) Unifying Control and Data Channels

Control Channel

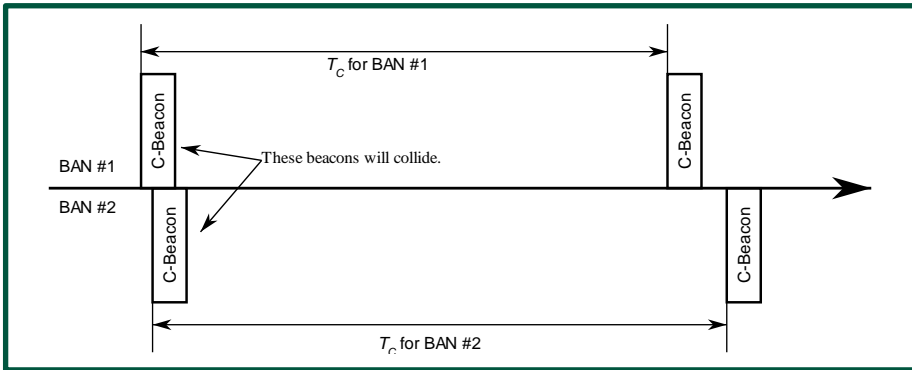

Data Channel

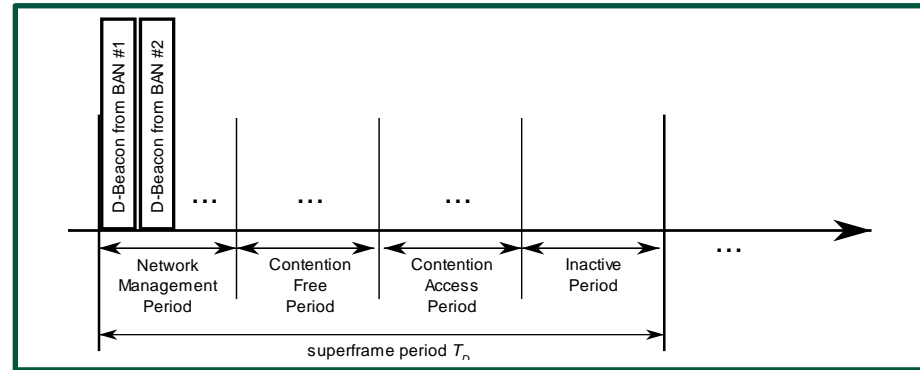

Frames for both Control Channel and Data Channels are accommodated into one single channel.

The time axis is divided into separate time periods for each frame

types.

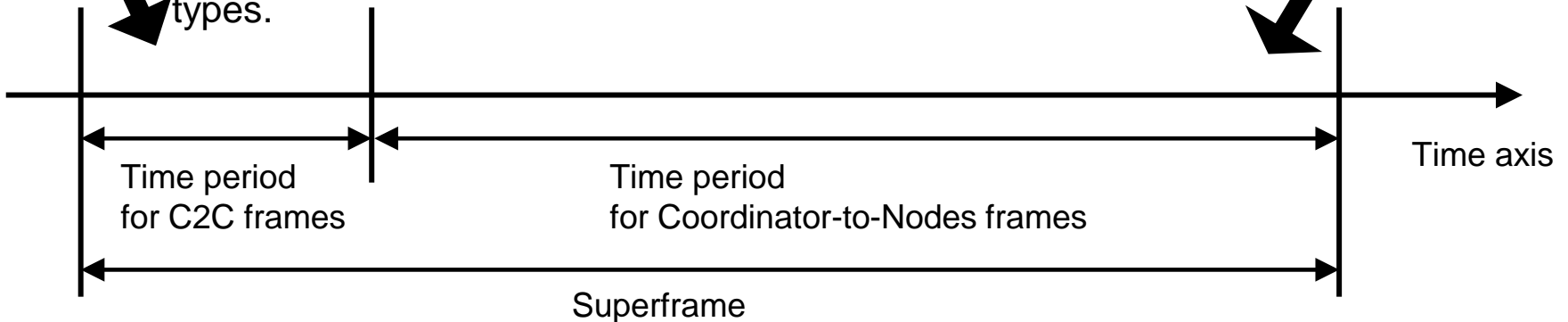

(2) Channel usage strategy

Case of low band, according to this proposal

Band group	Channel number	Central frequency (MHz)	Bandwidth (MHz)	Channel attribute in 802.15.6-2012	Channel attribute for the revision	
Low band	0	3494.4	499.2	Optional	Control	Optional
	1	3993.6	499.2	Mandatory	Control/Data	Mandatory
	2	4492.8	499.2	Optional	Control/Data	Optional



Band group	Channel number	Central frequency (MHz)	Bandwidth (MHz)	Channel attribute in 802.15.6-2012	Channel attribute for the revision	
Low band	0	3494.4	499.2	Optional	Control/Data	Optional
	1	3993.6	499.2	Mandatory	Control/Data	Mandatory
	2	4492.8	499.2	Optional	Control/Data	Optional

- All channels carry both Coordinator-to-Coordinator Frames and Coordinator-to-Node Frames.

(3) Motivation

- Low implementation difficulties
 - Requires only one UWB RF.
- Increase channel efficiency
 - All channel can carry Coordinator-to-Node frames.
 - Previously we had 1 control channel and n data channels. Now we have $n+1$ channels.

MAC Protocol Proposal for Multiple BAN Environment (Class 1), Proposal of control and data channels unification for 6ma MAC

15-22-0639, #15-23-0387

Doc.#802.15-23-0408-01-06a (July 2023)

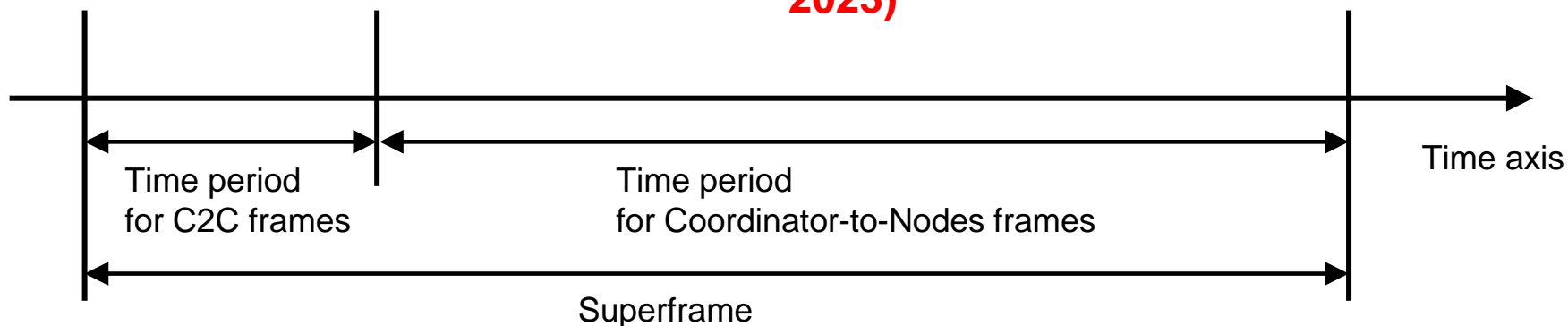

1. Unifying control and data channels into a single channel, instead of utilizing Control Channel, is proposed.
2. Frames for Coordinator to Coordinator link, previously carried by control channel, is carried by newly defined time period in the single channel.
3. For networks require higher dependability, feature of simultaneously utilizing multiple channel may still remain as optional.

Proposed text for 6ma MAC – General framework elements, Beacon Access Phase, Frames and IEs for dependable BAN, and Interference Avoidance

15-23-0322, # 15-23-0367, # 15-23-0369, # 15-23-0324

1. New terms are defined.
 - beacon access phase (BAP), coordinator hub, dependable BAN, dependable BAN group, leaf hub.
2. General explanation are modified according to new scope/features.
 - The revised standard will specify access coordination at the MAC sublayer between BANs.
3. Classes (1-3) of dependable BANs are defined.
 - In terms of bounded latency, probability of loss, update rate.
4. Length of superframe should be multiple times of fixed Basic Superframe Length.
5. Beacon Access Phase (BAP) is introduced.
 - A coordinator hub (a.k.a. super-coordinator or coordinator of coordinators) manage beacon slot allocation for leaf hubs. The last slot of BAP is reserved for a BAN of the original std.
6. New features such as Access offset, Access Phase shifting are introduced.
 - For mitigating the interference among coexisting dependable BANs, the start of access phase can be set differently.
7. Information Elements (IE) are added/defined according to the new features.

Convergence

1. Proposal # 15-22-0639 is going to be modified. the MAC will be able to use single channel too.
 - The fundamental difference of # 15-22-0639 and # 15-23-0322 series is already converged.
 - The detailed differences need to be examined more deeply, but the convergence of such differences will be much easier.
2. The differences in terminology will be also converged.
 - The two proposals have become very similar, but there are still many differences in terminology.
3. The convergence process will continue via teleconference prior to the September interim session, in order to complete the draft within the timeline.

**Doc.#802.15-22-0633-00-06a (November
2022)**

7.4 MAC Protocol Using Negotiation among Coordinators in Coexistence of Multiple Wireless BANs

7.4.1 Contention among Overlaid BANs

Issue

- Interference problem in the case where multiple BANs overlap (specifically, situations where people with BAN approaching)
- Because **the schedule adjustment between the coordinators has not been done**



Solution

- **Negotiation between coordinators**, scheduling between different BANs, to prevent deterioration due to inter-BAN interference

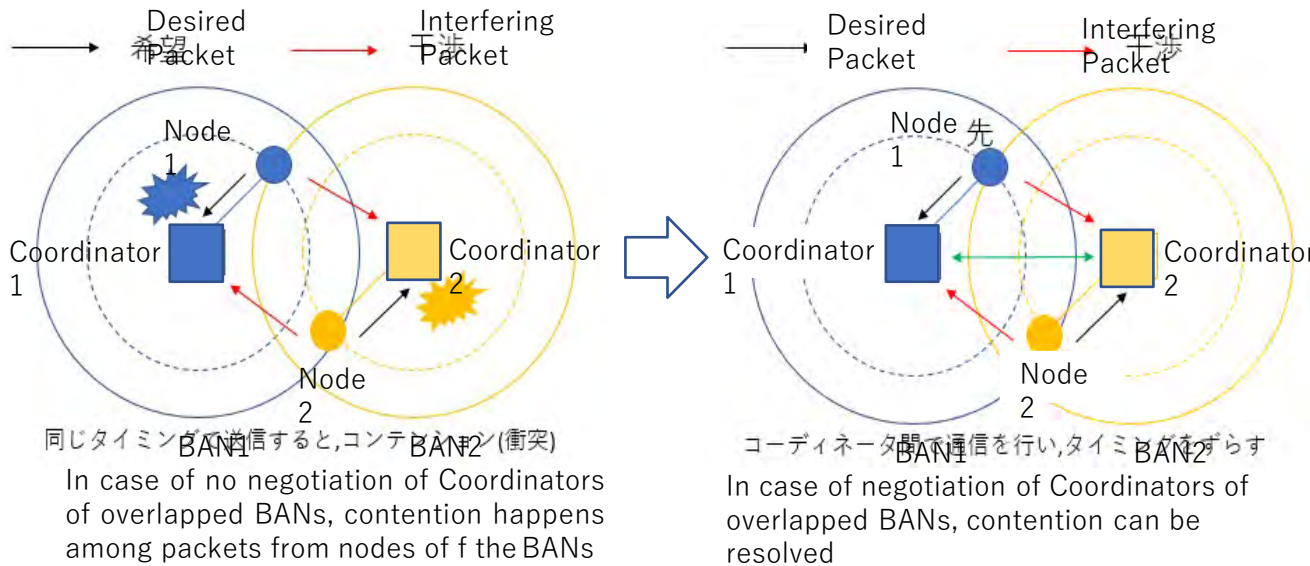

What is interference at the MAC layer

➤ Sensor nodes within the communication range try to transmit packets at the same timing, causing collisions, making it impossible to communicate correctly

Ref. R.Kohno, S.Ogawa, “MAC Protocol with Interference Mitigation Using Negotiation among Coordinators in Multiple Wireless Body Area Networks (BANs),” IEEE802.15 doc.#15-19-0119-00-0dep-ig-dep, Vancouver, Canada, March 12, 2019

7.4.2 Outline of proposed method

Purpose

- Increase the throughput of each BAN in case of interference
- Communication should be guaranteed in descending order of User Priority

Proposal

- Negotiate between coordinators, share the overlap situation of the sensor nodes, and identify the sensor nodes that will cause contention
- Do not send them at the same time

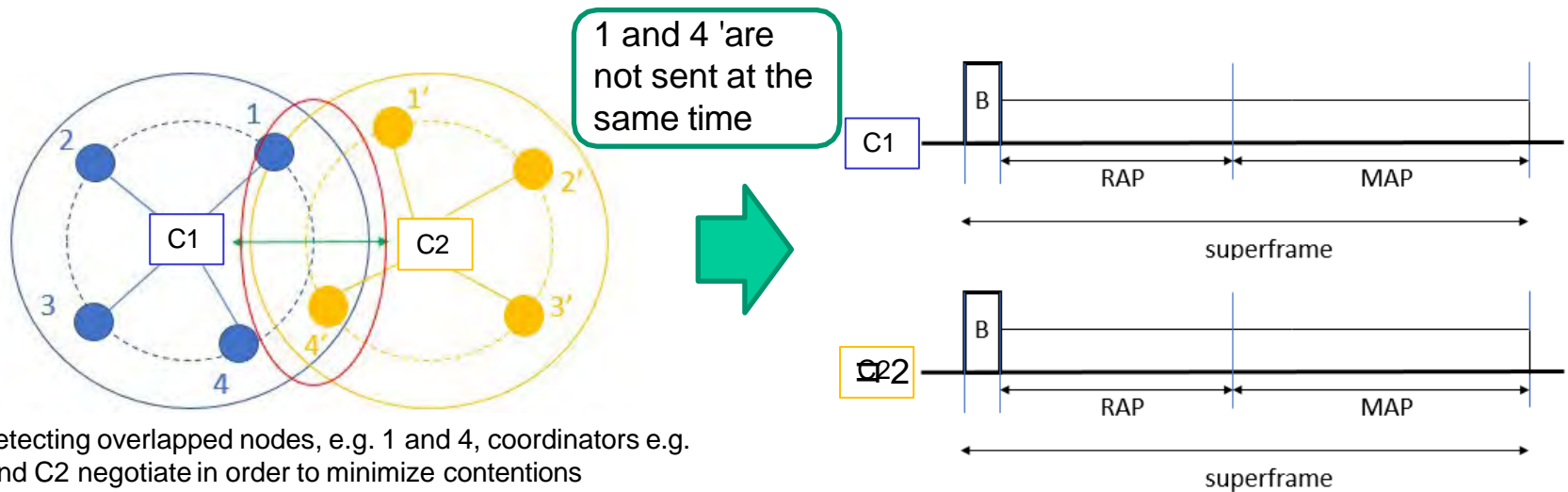

Fig3. Outline of proposed method

7.4.3 procedure of how to identify overlap situations

1. Since BAN uses UWB communication, it uses physical layer information that indicates the distance (between coordinators and sensor nodes)
 - By knowing the distance between a sensor node and the coordinator, it is possible to identify whether or not the node is within its communication range

2. Use the address of the sensor node given for each BAN
 - By sharing this address among the coordinators, it is possible to identify whether a sensor node within the trust range is under its own control or under the control of another

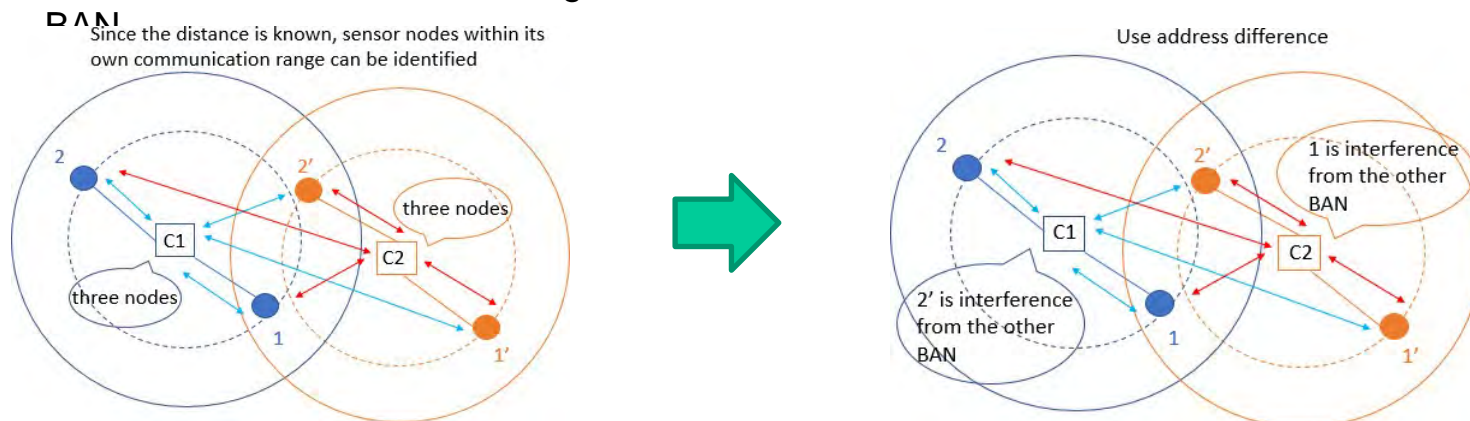

Fig4. how to identify overlap situations

7.4.4 MAC protocol of MAP(Managed access period)

Proposal

(Adopt polling for MAP)

- Divide Superframe's MAP structure into two parts, MAP 1 and MAP 2
- 1. In MAP 1, sensor nodes **not related to interference** are allocated
 - Send at the same time
- 2. In MAP 2, sensor nodes **related to interference** are allocated
 - When one BAN attempts to transmit at MAP 2, the other BAN is placed in a standby state

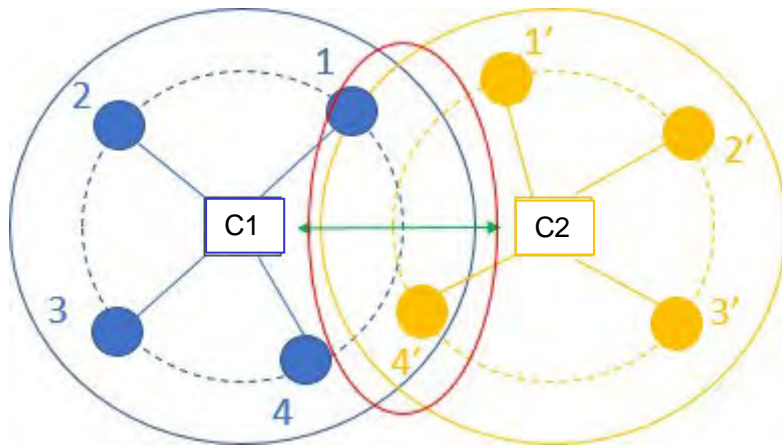

		MAP1			MAP2		
		Non Overlapped Nodes			Overlapped Nodes		
C1	B	4	2	3	1	×	1
		○	○	○	○		○
C2	B	○	○	○	○		
		1'	3'	2'	×	4'	×

○は送信成功, ×は待機状態

Fig4. MAC protocol of MAP

◆ By separating by interference and non-interference, packet collision does not occur and efficient transmission can be done

7.4.5 MAC protocol of RAP(Random Access Period)

Proposal (Adopt CSMA / CA for RAP)

- The Superframe's RAP protocol is as follows
- 1. If the interfering node is low UP (4 or less), do not conflict transmission rights (those with lower UP than competing nodes do not compete)**
 - 2. If the interference node is high UP (5 or more), compete transmission rights of normal CSMA/CA**

Although contention will occur, it will guarantee in descending order of UP

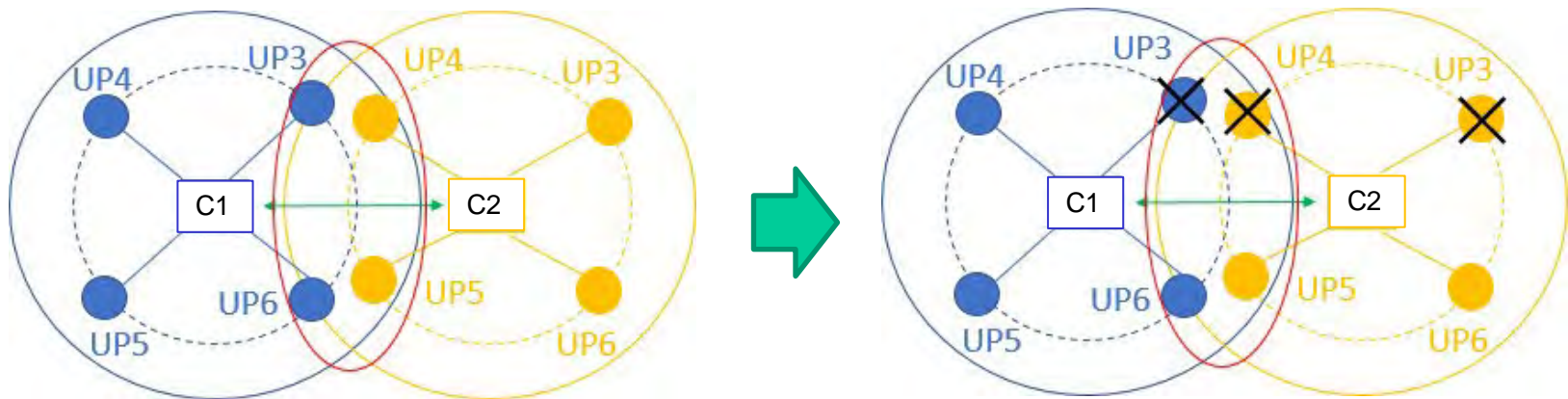

Fig5. MAC protocol of RAP

- It is possible to reduce the contention of packets while guaranteeing in descending order of UP**

7.4.6 Control to make the priority higher

- We propose a MAC protocol not only giving average performance as a whole, but also **differentiating between high UP and low UP**

RAP

- If it is low UP (4 or less) **irrespective of interference or non-interference**, do not compete transmission right
- If it is high UP (5 or more) **irrespective of interference or non-interference**, compete transmission right

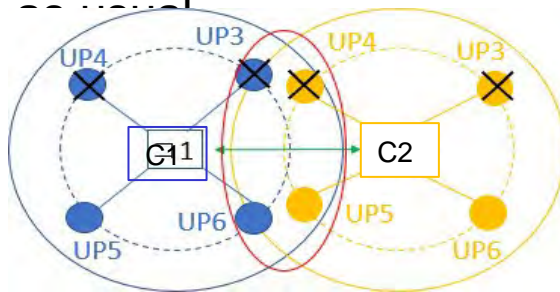

Fig8. RAP

MAP

How to assign transmission rights

The one with the largest
UP value × elapsed time



We changed the weighting
value called UP value

Weighting to make the priority more
dominant

- ◆ **By changing parameters, we can cope with each design policy (giving average performance , differentiating between high UP and low UP)**

8. TSN Possibility in WBAN 15.6ma

- 802.15.6 has BAN coordinator (hub) which can perform MAC bridge which connects two separate networks as **802.1 TSN**(Time Sensitive Network).
- A coordinator connects to nodes in its own network.
 - Not only same nodes operate on the same PHY, but also different PHYs.
- The revision may enable a coordinator to connect to other coordinators, to avoid interference and enhance dependability.
 - Unlike wired network, wireless network shares same medium and collision occurs which plays significant role in dependability.

8.1 Possible bridging in 802.15.6ma

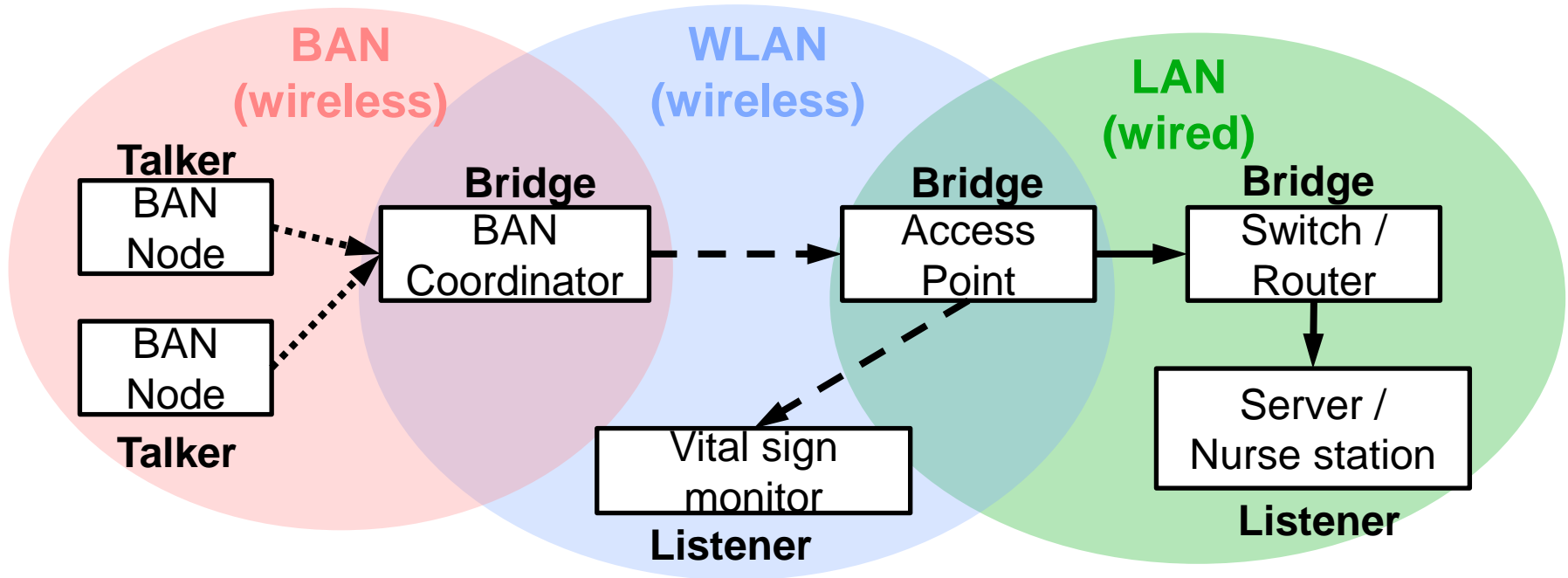

- BAN coordinator may relay frames to outer network as a MAC Bridge.

8.2 Coordinator to Coordinator Bridging

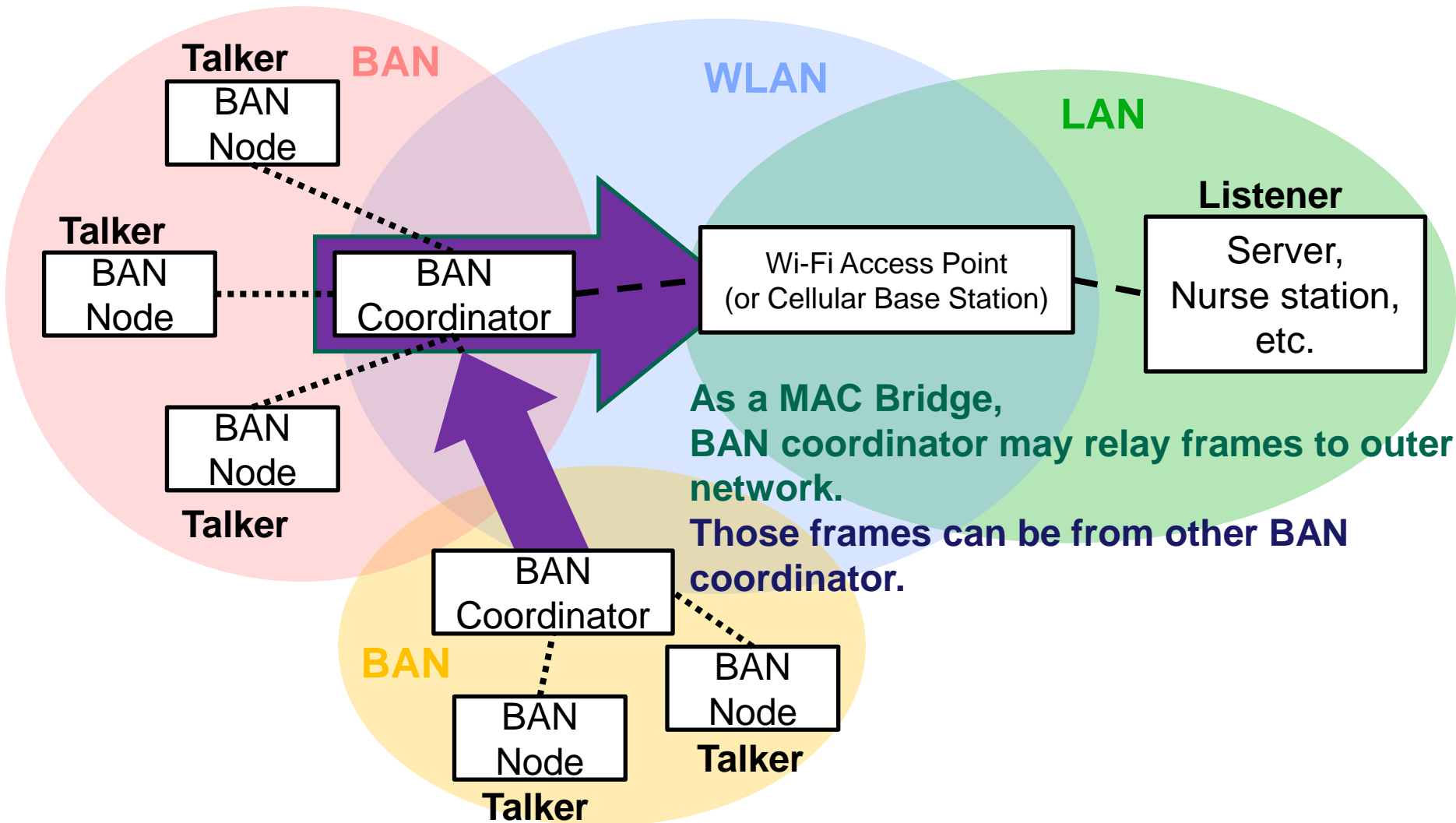

8.3 TSN equipment to infrastructure

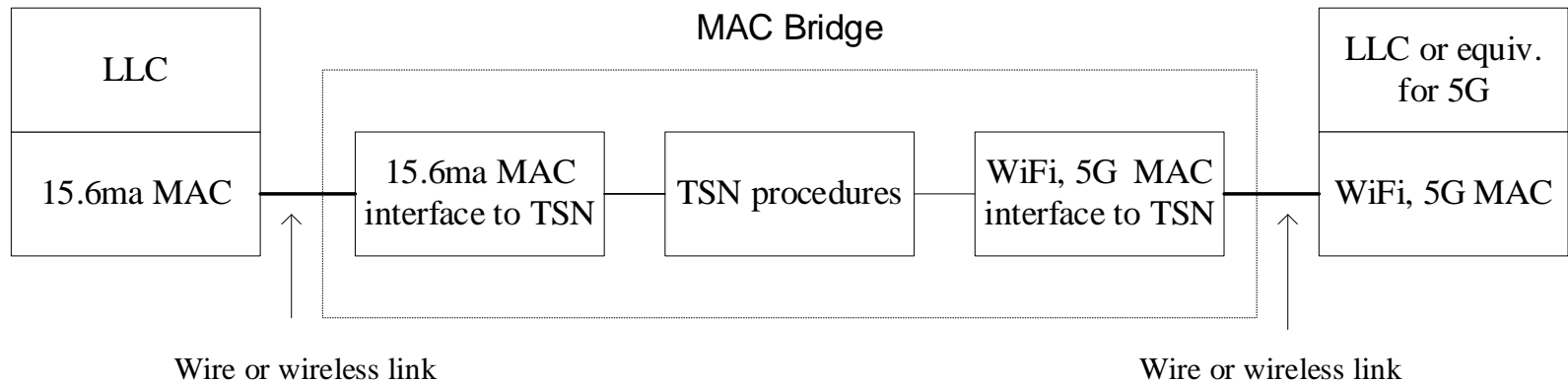

8.4 TSN in the 15.6ma protocol stack

	Application	Application
Layer 5,6,7	Payload	Payload
Layer 4	Proprietary/Other	TCP/UDP
Layer 3		IP
	LLC layer	
Layer 2	802.1 TSN interface	
	15.6ma MAC	
Layer 1	15.6ma PHY	

8.5 TSN switch

15.6ma should focus on the MAC layer

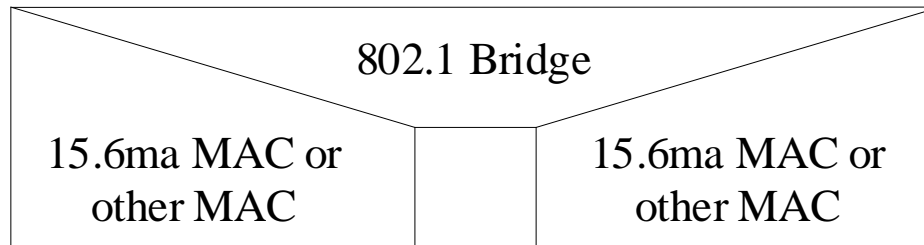

Fortunately, there is no conflict with 802.1 MAC addresses.

9. Letter Ballot 210 and Timeline of TG15.6ma

9.1 Result of Letter Ballot LB210 for the Draft P802.15.6ma_D03

		Draft P802.15.6ma	D3 LB210	
YES	88	VOTERS	122	Voting members: 122
		VOTED	96	Nearly voting members: 3
NO	0	YES	88	Aspirant voting member: 25
		ABSTAIN	8	
ABSTAIN	8	NO	0	
		% VOTERS	78.69%	
		% YES	100.00%	
total votes	96	% ABSTAIN	8.33%	
		Did Not Vote	26	

Result of LB210 (Sept.20-Oct.20)

- **78.69% of Voters voted YES which is over 75%. Then LB210 was officially Approved.**
- **Voted YES with and without Comments are 88 while No. of Comments is 113.**
- **In Vancouver Interim Meeting November 2024, Comments Resolution was done.**
- **In Kobe Interim Meeting January 2025, the Revised Draft P802.15.6ma_D04 will be approved in WG802.15. Then it will be recirculated in LB.**

9.2 CRG for draft document P802-15-6ma

- For comments in Letter Ballot and Supponsor Ballot, CRG(Comment Resolution Group) must be coordinated. CRG consists of about 4-6 voters of whom members in the same affiliation should not be beyond 20%. TG Chair must be a member.
- CRG Members
 1. Ryuji Kohno (YNU/YRP-IAI)
 2. Huan-Bang Li (NICT)
 3. Takumi Kobayashi (Nitech)
 4. Seong-Soon Joo (KPST)

9.3 TG 6ma Timeline(expected)

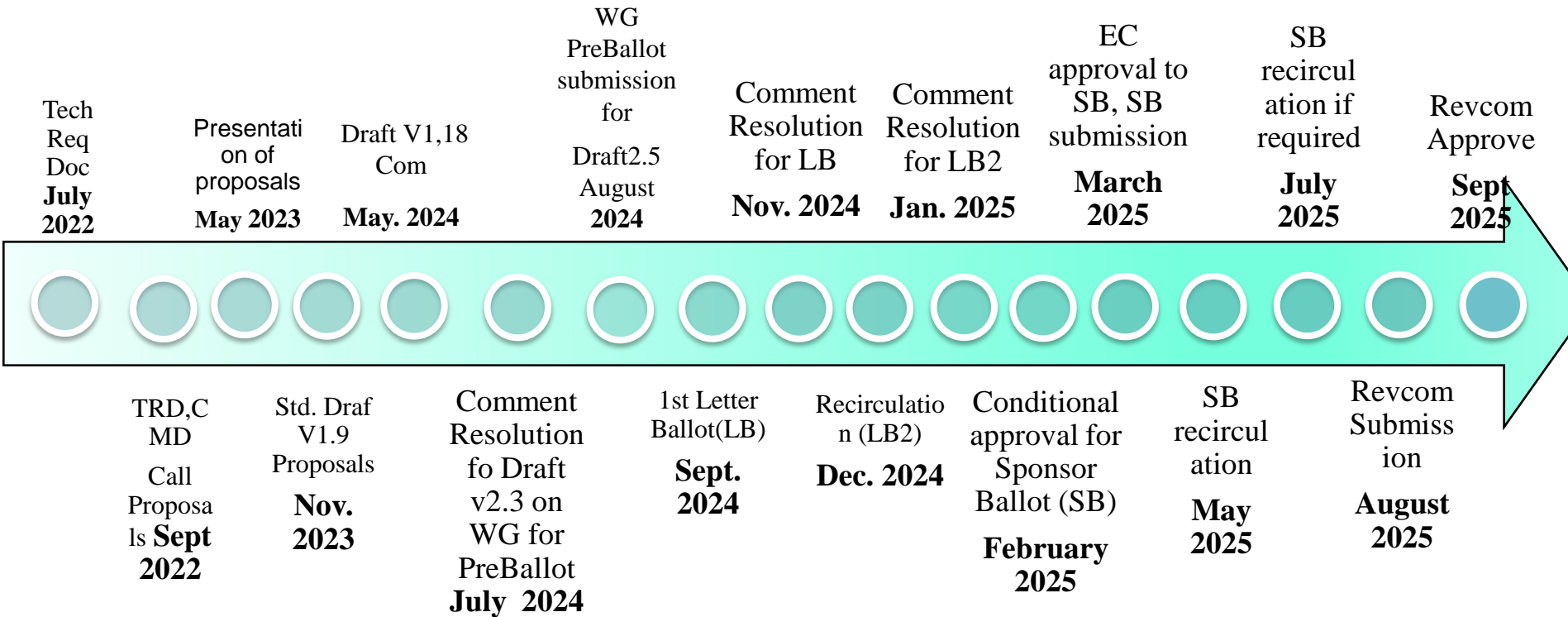

Notes: SASB/RevCom scheduled for 2024 a guess

9.4 Expecting Timeline detail

Topic item	Deadline	Action items	Notes
Std Draft D2_3 WG pre-ballot recirculation.	July/2024		Editorial comments from 802.15 technical editor were addressed. Still missing cross-references.
Towards the July 2024 meeting	July/2024	Adding MAC text. Revise PHY text. Editorial revisions.	
Target WG letter ballot (LB) submission: submit draft to TEG	August/2024	Disposition of comments.	1. Based on pre-ballot resolutions, prepare Draft D2_4 2. Request LB submission before the September meeting. Consequently, the July meeting is used to resolve comments.
TG and WG Motion to letter ballot (LB) submission: submit draft to EC	Sep/2024	TG and WG Motion to LB	Prepare all necessary documents: Project Task List, Progress Repor, Coexistence Assurance(CA) document, TG Motion to LB, WG Motion to LB
1st LB circulation	Sep/2024		Comment-resolutions to LB recirculation.
Comment Resolution for LB	Nov/2024		Comment-resolutions to LB recirculation.
2nd LB recirculation	Nov/2024		Comment-resolutions to LB recirculation.
Conditional approval for Sponsor Ballot (SB)	Nov/2024		Seek conditional approval for SB by the Executive Committee.
Final LB recirculation.	Jan/2025		WG approval to request SB submission.
Request EC approval for SB	Jan/2025		Request SB approval by the EC (conditional or not)
IEEE SA Sponsor Ballot submission	March/2025		One month for IEEE SA editorial review.
1st SB recirculation	May/2025		Comment-resolutions to SB and recirculation.
2nd SB recirculation	Jun/2025		Comment-resolutions to SB and recirculation.
Request conditional/unconditional approval to RevCom	Jun/2025		Submission to SASB agenda
Final SB recirculation, if required. Submission to RevCom	July/2025		Submission to SASB
RevCom submission	July/2025		RevCom approval

Note: the deadlines are subject to change.

Reference: doc.#15-23-0369-09-06ma

10. Concluding Remark

- Corresponding request from ETSI smart BAN and smart M2M, IG-DEP and its successive SG15.6a have discussed to focus on internal car network for IoT/M2M connections that is focused on BAN for human and car bodies.
- As a revision of IEEE802.15.6, MAC for multiple BANs can be guaranteed to satisfy permissible delay or back-off time and throughput of high QoS packets for human and vehicle BANs while maintaining average performance.
- As a revision of IEEE802.15.6, PHY for UWB radios should be revised for updated UWB regulation. In particular, coexistence among different UWB radios of IEEE802.15 such as 15.4a, 4f, 4z, 4ab can be supported.
- To include new use cases with enhanced dependability such as ECoG for Brain-Machine-Interface, technical requirement was updated to cover higher data rate.
- Core technologies such as multiple channel coding including HARQ corresponding to classes of coexistences and QoS levels of packets and interference mitigation in PHY layer have been involved in the revision.
- Core technologies in MAC layer have been involved in the revision such as control/data channels, C2C communication and ranging,
- First Letter Ballot 210 for draft Std, 802.15.6ma_D03 was approved in October. Then Comments Resolution have been proceeded in November Meeting.
- After confirm revised draft 802,15,6ma_D04 by WG Technical Editor and CRG, it will be recirculated after January Meeting,

Contacts and Conference Call

1. Chair; Ryuji Kohno, YNU/YRP-IAI
kohno@ynu.ac.jp, kohno@yrp-iai.jp
2. 1st Vice-Chair; Marco Hernandez, YRP-IAI/CWC
marco.hernandez@ieee.org
2nd Vice-Chair; Daisuke Anzai, NIT
anzai@nitech.ac.jp
3. Secretary; Takumi Kobayashi, YNU/TCU
kobayashi-takumi@yrp-iai.jp, kobayashi@nitech.ac.jp
4. Technical Editors;
Minsoo Kim, YRP-IAI minsoo@minsookim.com
Seong-Soon Joo, KPST wowbk@kpst.co.kr
Kento Takabayashi, Toyo U. takabayashi.kento.xp@gmail.com
Marco Hernandez, YRP-IAI/CWC marco.hernandez@ieee.org

- **Thank You !**
- **Any Questions ?**