

Project: IEEE P802.15 Working Group for Wireless Specialty Networks

Submission Title: Basic Consensus in MAC and PHY of Revision of IEEE802.15.6-2012(IEEE802.15.6ma)

Date Submitted: January 13th, 2025

Source: Ryuji Kohno^{1,2}, Minsoo Kim¹, Takumi Kobayashi^{1,4}, Marco Hernandez^{1,3}, Seong-Soon Joo⁶, Daisuke Anzai⁴, Kento Takebayashi⁵, Jussi Hapola³

Company: ¹Yokosuka Research Park International Alliance Institute (YRP-IAI), ²Yokohama National University (YNU), Japan, ³Centre for Wireless Communications(CWC), University of Oulu, Finland, ⁴Nagoya Institute of Technology, ⁵Toyo University, ⁶Korea Platform Service Technology (KPST), Korea

Address: ¹YRP 1, 3-4 Hikarino-oka, Yokosuka, 239-0847 Japan; ²79-5 Tokiwadai, Hodogaya-ku, Yokohama, 240-8501 Japan, ³PO Box 4500, FI-90014 University of Oulu, Finland

Voice: ²+81-90-5408-0611, **Fax:** ²+81-45-383-5528, **E-Mail:**[kohno@yrp-iai.jp, minsoo@minsookim.com; kobayashi-takumi@yrp-iai.jp, anzai@nitech.ac.jp, Marco.Hernandez@ieee.org, petrucciniyng@gmail.com, wowbk@kpst.co.kr, jussi.hapola@oulu.fi]

Re: In response to call for technical contributions

Abstract: This document contains a basic consensus of MAC of IEEE802.15.6ma to realize the enhanced reliability of P802.15.6ma.

Purpose: Material for discussion in P802.15.6ma TG

Notice: This document has been prepared to assist the IEEE P802.15.6ma. It is offered as a basis for discussion and is not binding on the contributing individual(s) or organization(s). The material in this document is subject to change in form and content after further study. The contributor(s) reserve(s) the right to add, amend or withdraw material contained herein.

Release: The contributor acknowledges and accepts that this contribution becomes the property of IEEE and may be made publicly available by P802.15.6ma.

Basic Consensus in MAC and PHY of Revision of IEEE802.15.6-2012 (IEEE802.15.6ma)

Ryuji Kohno^{1,2}, Minsoo Kim¹, Takumi Kobayashi^{1,4},
Marco Hernandez^{1,3}, Seong-Soon Joo⁶, Daisuke Anzai⁴,
Kento Takebayashi⁵, Jussi Haapola³

¹Yokosuka Research Park International Alliance Institute (YRP-IAI)

²Yokohama National University (YNU), Japan

³Centre for Wireless Communications(CWC), University of Oulu, Finland,

⁴Nagoya Institute of Technology(NIT) Japan,

⁵Toyo University(TU), Japan,

⁶Korea Platform Service Technology (KPST), Korea

1. Basic Consensus

- IEEE802.15.6ma; revision of IEEE802.15.6-2012 focuses on enhanced dependability in data transmission and ranging in classified environments of coexistence with the same and other frequency shared wireless networks.
- 15.6ma covers new and conventional channel models of major use cases of 802.15.6ma Body Area Networks (BAN) are for human and vehicle bodies in medical and automotive applications for enhanced dependability.
- **15.6ma supports some backward compatibility with 15.6-2012 as much as possible but not all of them in PHY and MAC. 15.6ma aims to replace 15.6-2012 for enhanced dependability.** For instance, 15.6ma focuses on only UWB in PHY and only time structure mode in MAC.

1. Basic Consensus(2/2)

- In order to perform enhanced dependability in revision of IEEE802.15.6-2012(IEEE802.15.6ma), coexistence environments have been classified. **Some classes of multiple new and legacy BANs coexistence are focused to manage packet contention in MAC layer while other classes are taken care by mitigation of interference in Physical layer(PHY) and manage contention in MAC.**
- Ranging in 802.15.6ma is optional but **ranging between coordinators of neighbouring or coverage overlaid BANs is helpful to identify geographical overlay and mobility of incoming and outgoing to determine coexistence class states.** Ranging between BAN coordinator and its nodes in star topology in 802.15.6ma is the same as 802.15.4z and its amendment.

2. 15.6ma PHY and MAC New Features(1/2)

Since IEEE802.15.6-2012 has too many modes in PHY and MAC, 15.6ma chooses a few modes to simplify specification of PHY and MAC while introduces new error-controlling schemes of FEC and HARQ, and management and data channels for enhanced dependability in various channel models and 8 classes of coexistence models for 8 levels of QoS priority order packets such as

1. PHY

- Various channel coding and decoding matched with QoS priority levels of packets and coexistence classes
- Interference mitigation schemes according to various environment of coexistence classes

2. MAC

- Two channels using two UWB band channels are applied for management channel to control frames of coexisting networks and data transmission channel. **Its alternative mode is two channels for management and data transmission using a single UWB band channel.**
- Coordinator-to-coordinator(C2C) negotiation of existing networks

3. Cross Layer of PHY and MAC

- Hybrid ARQ for higher priority of packets in high class of coexistence

2. 15.6ma PHY and MAC New Features(2/2)

3. Cross Layer of PHY and MAC

- Hybrid ARQ for higher priority of packets in high class of coexistence
- For the sake of easy implementation, hybrid ARQ is optional in limited high classes of coexistence.
- Ranging between coexisting BANs' coordinators could be proceeded by C2C(coordinator-to-coordinator) functionality.
- Ranging information in PHY is applied for identifying coexistence class states in which appropriate MAC is selected.

3. Channel models and scenarios in IEEE802.15.6ma

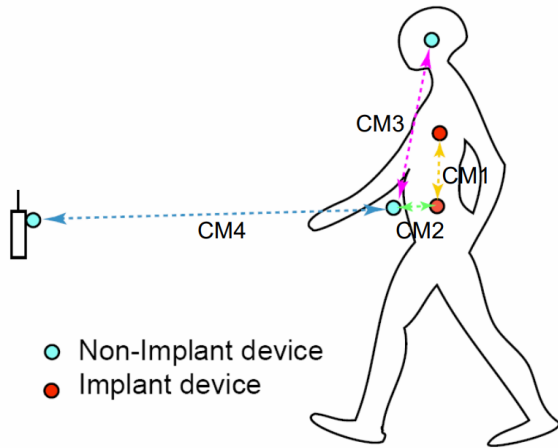

- Non-Implant device
- Implant device

- Path loss (Mandatory)
- Optional;
 - Fading (Small scale/ large scale)
 - Shadowing
 - Power delay profile

Specific use cases

Implant to Body Surface for BCI
Implant to External for BCI
Body surface to body surface for BCI
Body Surface to External for BCI
Implant to body surface for capsule endoscopy

Scenario	Description	Frequency Band	Channel Model
S2	Implant to Body Surface	402-405 MHz,	CM2
S2.1	Implant (upper body) to Body Surface	3.1-10.6 GHz UWB	CM2.1
S2.2	Implant (head) to Body Surface	3.1-10.6 GHz UWB	CM2.2
S3	Implant to External	402-405 MHz, 3.1-10.6 GHz UWB	CM2
S4	Body Surface to Body Surface (LOS)	400, 600, 900 MHz 2.4, 3.1-10.6 GHz	CM3
S4.1	Body Surface to Body Surface (LOS)	3.1-10.6 GHz CM4.1	CM4.1
S5	Body Surface to Body Surface (NLOS)	400, 600, 900 MHz 2.4, 3.1-10.6 GHz	CM3
S6	Body Surface to External (LOS)	900 MHz 2.4, 3.1-10.6 GHz	CM4
S6.1	Body Surface (head) to External (LOS)	3.1-10.6 GHz	CM6.1
S7	Body Surface to External (NLOS)	900 MHz 2.4, 3.1-10.6 GHz	CM4

3.1 Classification of Channel and Environment Models for Human and Vehicle Body Area Networks (HBAN&VBAN)

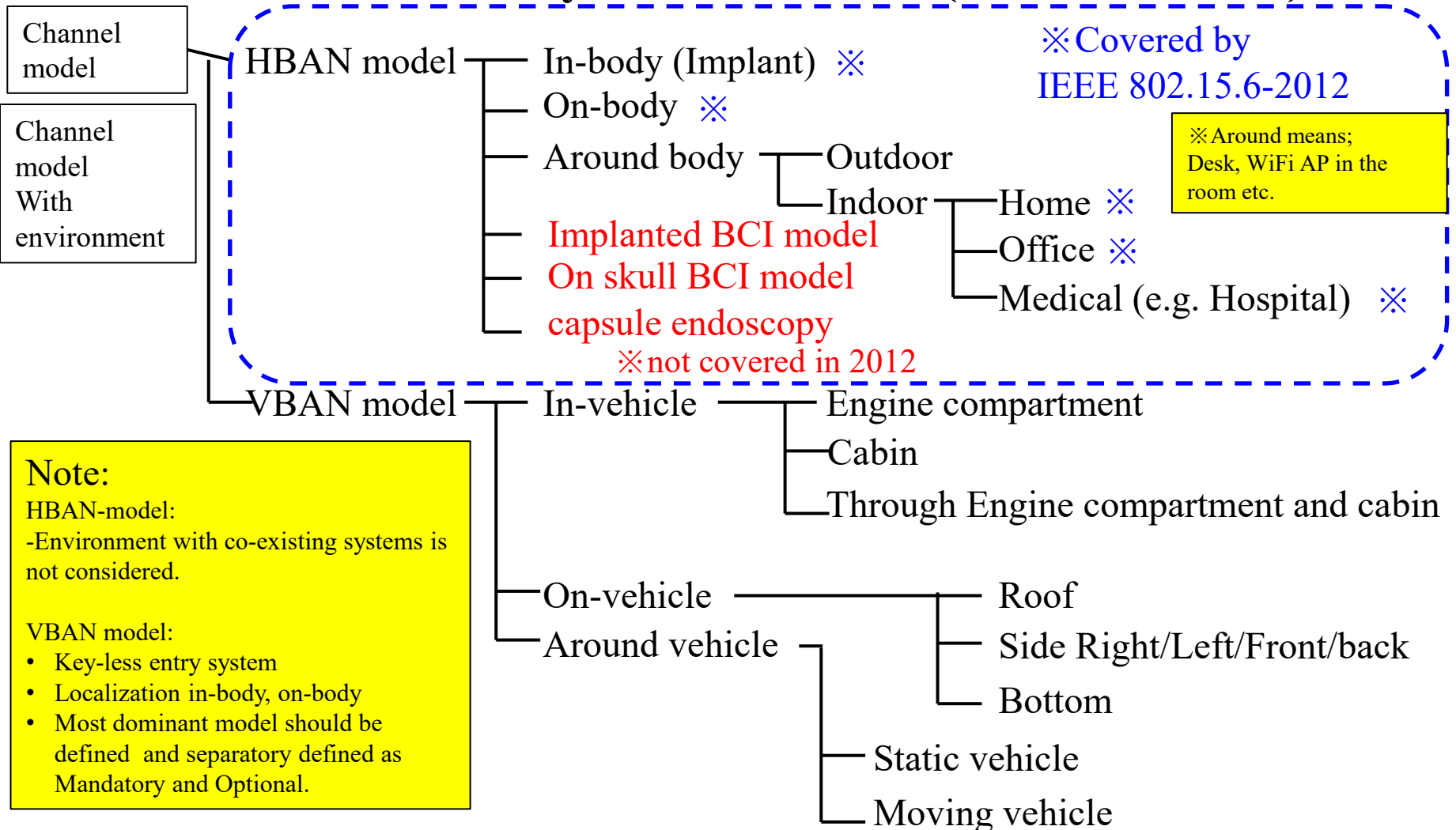

4. 8 Levels of Packets corresponding to User Priority of QoS in IEEE802.15.6 and 6ma

- In Std.15.6 WBAN systems, a various data such as vital signs, skin temperature, blood pressure, ECG, EEG, ECoG, and vehicle controlling commons have different QoS levels corresponding to user priority.
- In 15.6ma for dependable WBAN for human and vehicles, data packet transmission should be dependable according to QoS levels even in various classes of coexistence environment.
- Therefore, **appropriate sets of error controlling scheme with FEC and hybrid ARQ** corresponding to QoS levels have been standardized in 15.6ma,

User priority	Traffic designation	Frame type
0	Background (BK)	Data
1	Best effort (BE)	Data
2	Excellent effort (EE)	Data
3	Video (VI)	Data
4	Voice (VO)	Data
5	Medical data or network control	Data or management
6	High-priority medical data or network control	Data or management
7	Emergency or medical implant event report	Data

5. 8 Classes of Coexistence Environment Models

Coexistence Class	Coexisting system(s)					Category
	802.15.6ma	802.15.6-2012	Non-UWB (ex. Wi-Fi / Unlicensed / 3GPP)	802.15 UWB (ex. 802.15.4)	Non-802.15 UWB (ex. ETSI SmartBAN)	
Class 0	-	-	-	-	-	Single BAN
Class 1 (1a)	✓	-	-	-	-	Multiple 15.6 BANs
Class 2 (1b)	✓	✓	-	-	-	
Class 3	✓	-	✓	-	-	Non-UWB
Class 4 (2a)	✓	-	-	✓	-	Multiple UWB systems
Class 5 (2b)	✓	-	-	-	✓	
Class 6 (2c)	✓	-	-	✓	✓	
Class 7	✓	✓	✓	✓	✓	Final Boss

The coexistence class has been redefined to 8 levels, which can be represented by 3 bits and would be suitable to include in PHY or MAC headers.

MAC Proposal of TG15.6ma (Revision of IEEE802.15.6-2012)

Definition of Coexistence Classes and How to Support Higher Classes

May 15th, 2022

Minsoo Kim, Takumi Kobayashi, Marco Hernandez,
and Ryuji Kohno
Yokohama National University(YNU),
YRP International Alliance Institute(YRP-IAI)

Introduction

- The goal of this revision is to enhance dependability.
- This presentation focuses on the challenges of coexistence, among other obstacles we face in achieving this goal.
- There is no one-size-fits-all solution to manage any coexistence scenario.
- To start with, we are outlining the various Classes of coexistence scenarios we anticipate in an environment where one or more Body Area Networks (BANs) and other radios are operating within the same coverage area.
- TG6ma is working on defining specification at the Physical (PHY) and Media Access Control (MAC) layers to enhance dependability at each the Class, maintaining a specific Quality of Service (QoS).

Definition of Coexistence Environment Classes

Coexistence Class	Coexisting system(s)					Category
	802.15.6ma	802.15.6-2012	Non-UWB (ex. Wi-Fi / Unlicensed / 3GPP)	802.15 UWB (ex. 802.15.4)	Non-802.15 UWB (ex. ETSI SmartBAN)	
0	-	-	-	-	-	Single BAN
1 (1a)	✓	-	-	-	-	Multiple 15.6 BANs
2 (1b)	✓	✓	-	-	-	
3	✓	-	✓	-	-	Non-UWB
4 (2a)	✓	-	-	✓	-	Multiple UWB systems
5 (2b)	✓	-	-	-	✓	
6 (2c)	✓	-	-	✓	✓	
7	✓	✓	✓	✓	✓	Final Boss

- We've redefined coexistence into 8 Classes, each of which can be represented using just 3 bits. This make them suitable to include in PHY or MAC headers.

Definition of Coexistence Environment Classes

(cont.)

- Class 0 (no other systems)
 - In this scenario, there is only one BAN operating within a specific area, with no other systems coexisting.
 - The required dependability in terms of throughput and latency should be met.

Definition of Coexistence Environment Classes (cont.)

- Class 1-2 (BANs Only)
 - In these Classes, multiple BANs, all based on 15.6ma revision (Class 1) or IEEE Std. 802.15.6 (Class 2), are operating within a specific area.
 - If the BANs are based on the 15.6ma revision, they could be Human BANs or Vehicle BANs.
 - These networks follow established communication protocols, allowing BANs to receive and decode frames from other coexisting BANs.
 - Each BAN should meet the required dependability.
 - The proposed 15.6ma MAC supports Class 1-2 using only mandatory features.

Definition of Coexistence Environment Classes

(cont.)

- Class 3 (BANs Plus Other Wireless Systems)
 - Here, several BANs are operating alongside other wireless systems within a specific area.
 - The proposed 15.6ma MAC supports Class 3 on a best-effort basis using some optional features.

Definition of Coexistence Environment Classes

(cont.)

- Class 4-6 (BANs Plus Other UWB Systems)
 - In these Classes, several BANs are operating alongside multiple non-BAN Ultra-Wideband (UWB) systems.
 - These UWB systems may follow other standards such as 15.4 or ETSI SmartBAN.
 - Although they follow known communication schemes, a BAN might not fully decode their frames due to hardware limitation.
 - However, note that 15.6ma devices may be able to decode 15.4ab frames.
 - All coexisting BANs should meet the required dependability.
 - The proposed 15.6ma MAC supports Class 4-6 with the help of optional features.

6.2 Coexistence Class States Transition(1/2)

- The standard's revision supports BANs operating with high reliability (coexistence class 0) and coexisting in dense environments with intra-interference and inter-interference (coexistence class 1 to 7). Figure 6 shows the state transition between several classes of coexistence environments defined in above – mentioned table.

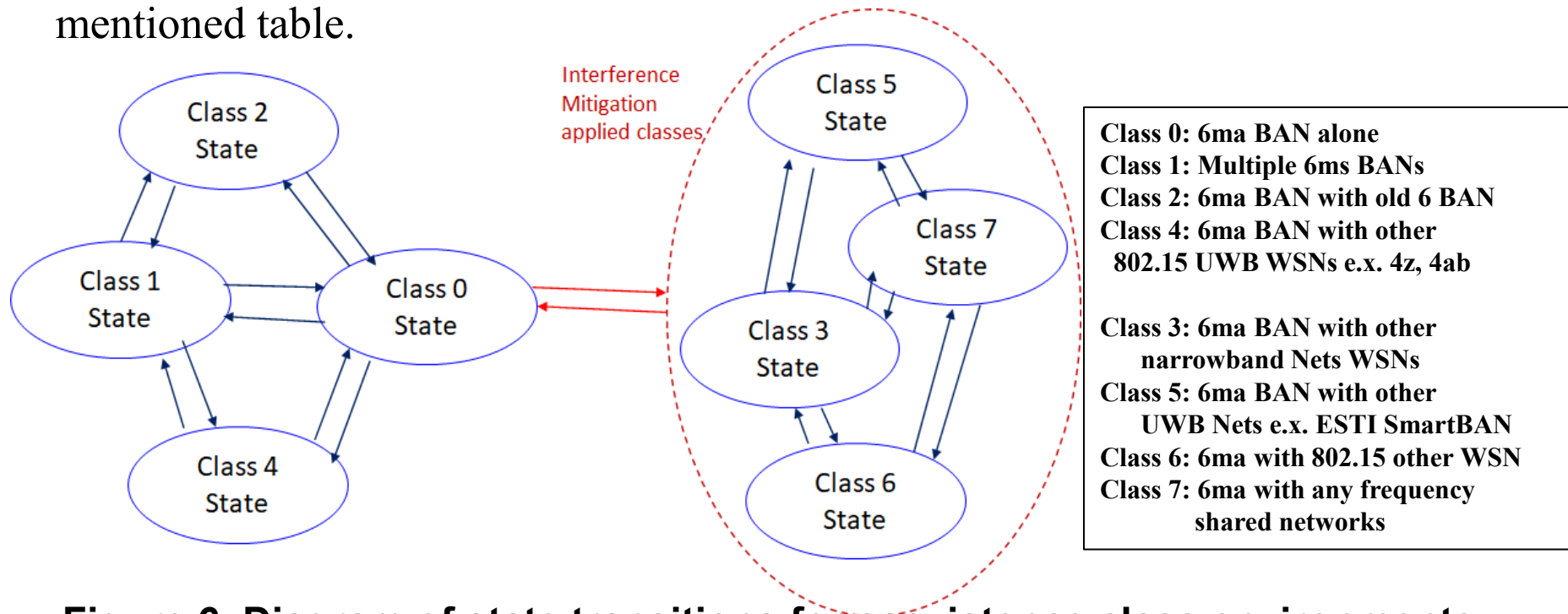

Figure 6 Diagram of state transitions for coexistence class environments.

6.2 Coexistence Class States Transition(2/2)

- The standard's revision focuses on the dependability mechanisms for a single HBAN or VBAN (Class 0) and the scenario with multiple HBANs or VBANS (Class 1).
- Class 2 supports compatibility with legacy BANs (IEEE 802.15.6-2012 Std).
- Class 4 supports coexistence with other IEEE 802.15 UWB Stds, and amendments such as 15.4, 15.8, 15.4z, and 4ab, via the PHY and MAC specification.
- **Classes 3, 5, 6, and 7 support coexistence with other wireless systems can result in Class 0, 1, and 2 by mitigation technology to cancel interference from other radios except legacy 15.6 at the receiver side (see clause 4.7.2 of draft#1.11).**
- During CCA, a BAN coordinator may analyze the type of synchronization preamble detected from a 15.6ma, 15.6, or 15.4 system.
- In Figure 6, the state transition probabilities are approximated in consecutive superframes. Furthermore, the duration of the CAP and CFP are determined by statistics of various QoS level of packets in previous consecutive superframes for every coming superframe.
- The draft revision #1.11 supports BANs operating with high reliability in dense environments coexisting with intra-interference and inter-interference due to other wireless systems in the same frequency band. Figure 6 shows state transition among several classes of coexistence environment defined in Table 1.

Supporting higher coexistence Classes

- Allocate time slots (or periods) for each BAN to prevent collisions.
 - This requires coordination between networks and increase system complexity.

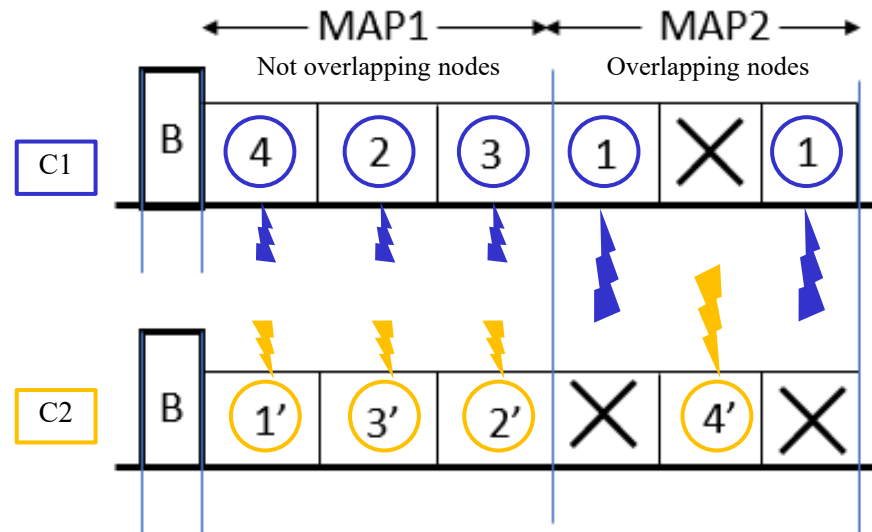

Supporting higher coexistence Classes (cont.)

- Use multiple channels in frequency domain to support more networks.
 - This requires multi-UWB-channel compatible hardware, potentially increasing hardware cost.

Band group	Channel number	Central frequency (MHz)	Bandwidth (MHz)	Channel attribute in 802.15.6-2012	Channel attribute for the revision	
Low band	0	3494.4	499.2	Optional	Control	Optional
	1	3993.6	499.2	Mandatory	Control/Data	Mandatory
	2	4492.8	499.2	Optional		Optional
High band	3	6489.6	499.2	Optional	Control/Data	Optional
	4	6988.8	499.2	Optional		Optional
	5	7488.0	499.2	Optional	Control	Optional
	6	7987.2	499.2	Mandatory	Control/Data	Mandatory
	7	8486.4	499.2	Optional		Optional
	8	8985.6	499.2	Optional		Optional
	9	9484.8	499.2	Optional		Optional
	10	9984.0	499.2	Optional		Optional

Balancing dependability and cost

- Achieving higher dependability inevitably comes with increased costs, which may pose challenges for widespread adoption.
- The parameters of the coexistence environment, such as the number of coexisting systems, need to be set at a feasible Class, taking both complexity and cost into account.
- One possible solution is to classify coexistence algorithms into mandatory and optional features.
 - Users who need higher dependability can opt for devices that support higher Classes of coexistence environment by offering optional features.

Summary

- We have categorized coexistence environments into 8 distinct Classes based on the variety of coexisting systems.
- To manage more complex coexistence environments, we propose strategies in both the time and frequency domains.
- In order to manage increased costs, we suggest classifying certain coexistence features as optional, allowing for tailored solutions based on specific user requirements.

References

- [1] 15-19-0503-01-0dep, MAC Protocol with Interference Mitigation Using Negotiation among Coordinators in Multiple Wireless Body Area Networks (BANs)
- [2] 15-22-0277-04-006a, MAC ideas for BAN with Enhanced Dependability

Physical Layer(PHY) Specification

6. PHY Specification of Error-Control Defined Corresponding Combination of 8 QoS Levels and 8 Coexistence Classes

Coexistence Class	0	1	2	3	4	5	6	7
QoS Level								
0	BCC	BCC+E	BCC+E	BCC+E			HARQ	HARQ
1	BCC	BCC+E	BCC+E	BCC+E			HARQ	HARQ
2	BCC	BCC+E	BCC+E	BCC+E			HARQ	HARQ
3	BCC	BCC+E	BCC+E	BCC+E			HARQ	HARQ
4	BCC	BCC+E	BCC+E	BCC+E			HARQ	HARQ
5	BCC	BCC+E	BCC+E	BCC+E			HARQ/IM	HARQ/IM
6	CFP/HARQ	CFP/HARQ	CFP/HARQ	CFP/HARQ	CFP/HARQ	CFP/HARQ	HARQ/IM	HARQ/IM
7	CFP/HARQ	CFP/HARQ	CFP/HARQ	CFP/HARQ	CFP/HARQ	CFP/HARQ	HARQ/IM	HARQ/IM

6.2 Channel Coding Table #1 for Class 0 and 1

Common with IEEE802.15.4ab

Error-correcting codes corresponding to QoS levels

User priority	Inner code	Outer code	HARQ
0	15.4ab LDPC or BCC (R=1/2)		-
1	15.4ab LDPC or BCC (R=1/2)		-
2	15.4ab LDPC or BCC (R=1/2)		-
3	15.4ab LDPC or BCC (R=1/2)		-
4	15.4ab LDPC or BCC (R=1/2)	(200,168) shortened RS code	-
5	15.4ab LDPC or BCC (R=1/2)	(200,168) shortened RS code	-
6	15.4ab LDPC or BCC (R=1/2)	(200,168) shortened RS code	-
7	15.4ab LDPC or BCC (R=1/2)	(200,168) shortened RS code	-

- As an outer code, shortened Reed-Solomon (RS) codes with N=200 (original code length N=255) will be selected to correct burst errors due to interference from other WBANs and the coding rates are changed according to each QoS and channel condition
- As an inner code, 15.4ab LDPC (K=324, 648, 972, R=1/2) or BCC will be selected for the coexistence of 15.6ma and 15.4ab
- This updated concept table is considered as the first priority

6.2 Channel Coding Table #2 for Class 2

Common with IEEE802.15.4ab

User priority	Inner code	Outer code	HARQ
0	15.4ab LDPC or BCC (R=1/2)		-
1	15.4ab LDPC or BCC (R=1/2)		-
2	15.4ab LDPC or BCC (R=1/2)		-
3	15.4ab LDPC or BCC (R=1/2)		-
4			○
5			○
6			○
7			○

Hybrid ARQ (HARQ) for High QoS packets

- As an outer code, shortened Reed-Solomon (RS) codes with N=200 (original code length N=255) will be selected to correct burst errors due to interference from other WBANs and the coding rates are changed according to each QoS and channel condition
- As an inner code, 15.4ab LDPC (K=324, 648, 972, R=1/2) or BCC will be selected for the coexistence of 15.6ma and 15.4ab
- This updated concept table is considered as the first priority

6.2 Channel Coding Table #3 for **Class 5**

Common with IEEE802.15.4ab

Error-correcting codes corresponding to QoS levels

User priority	Inner code	Outer code	HARQ
0	15.4ab LDPC or BCC (R=1/2)		-
1	15.4ab LDPC or BCC (R=1/2)		-
2	15.4ab LDPC or BCC (R=1/2)		-
3	15.4ab LDPC or BCC (R=1/2)		-
4	15.4ab LDPC or BCC (R=1/2)		-
5	15.4ab LDPC or BCC (R=1/2)	(200,168) shortened RS code	-
6	15.4ab LDPC or BCC (R=1/2)	(200,168) shortened RS code	-
7	15.4ab LDPC or BCC (R=1/2)	(200,168) shortened RS code	-

- As an outer code, shortened Reed-Solomon (RS) codes with N=200 (original code length N=255) will be selected to correct burst errors due to interference from other WBANs and the coding rates are changed according to each QoS and channel condition
- As an inner code, 15.4ab LDPC (K=324, 648, 972, R=1/2) or BCC will be selected for the coexistence of 15.6ma and 15.4ab
- This updated concept table is considered as the first priority

6.2 Channel Coding Table #4 for Class 3, 4, 6 and 7

The same FEC for QoS levels 4,5,6 and 7 in Classes 0, 1, and 2

User priority	Inner code	Outer code	HARQ
0	15.4ab LDPC or BCC (R=1/2)	(200,168) shortened RS code	-
1	15.4ab LDPC or BCC (R=1/2)	(200,168) shortened RS code	-
2	15.4ab LDPC or BCC (R=1/2)	(200,168) shortened RS code	-
3	15.4ab LDPC or BCC (R=1/2)	(200,168) shortened RS code	-
4	15.4ab LDPC or BCC (R=1/2)	(200,168) shortened RS code	-
5			○
6			○
7			○

Hybrid ARQ (HARQ) for High QoS packets

- As an outer code, 15.4ab LDPC (K=324, 648, 972, R=1/2) codes will be selected for the coexistence of 15.6ma and 15.4ab
- As an inner code, 15.4a/z based convolutional codes (which are almost the same of our proposed decomposable codes) will be selected, and the coding rates are changed according to each QoS and channel condition, which can be applied to hybrid ARQ
- This table is considered as the second choice

Revious Version of FEC/HARQ for 64 Combinations of 8 Coexistence Classes × 8 QoS Packet Levels

Coexistence Class	0	1	2	3	4	5	6	7
QoS Level								
0	BCC	BCC+E	BCC+E	BCC+E			HARQ	HARQ
1	BCC	BCC+E	BCC+E	BCC+E			HARQ	HARQ
2	BCC	BCC+E	BCC+E	BCC+E			HARQ	HARQ
3	BCC	BCC+E	BCC+E	BCC+E			HARQ	HARQ
4	BCC	BCC+E	BCC+E	BCC+E			HARQ	HARQ
5	BCC	BCC+E	BCC+E	BCC+E			HARQ/IM	HARQ/IM
6	CFP/HARQ	CFP/HARQ	CFP/HARQ	CFP/HARQ	CFP/HARQ	CFP/HARQ	HARQ/IM	HARQ/IM
7	CFP/HARQ	CFP/HARQ	CFP/HARQ	CFP/HARQ	CFP/HARQ	CFP/HARQ	HARQ/IM	HARQ/IM

- FEC codes and Hybrid ARQ have been designed for $8 \times 8 = 64$ combinations for QoS levels and Coexistence classes under various standard of channel models.

6.3 Specification of Error-Control Defined Corresponding Combination of 8 QoS Levels and 8 Coexistence Classes

Coexistence Class	0	1	2	3	4	5	6	7
QoS Level								
0	LDPC or BCC	LDPC or BCC	LDPC or BCC	LDPC(in) & RS(out)	LDPC(in) & RS(out)	LDPC or BCC	LDPC(in) & RS(out)	LDPC(in) & RS(out)
1	LDPC or BCC	LDPC or BCC	LDPC or BCC	LDPC(in) & RS(out)	LDPC(in) & RS(out)	LDPC or BCC	LDPC(in) & RS(out)	LDPC(in) & RS(out)
2	LDPC or BCC	LDPC or BCC	LDPC or BCC	LDPC(in) & RS(out)	LDPC(in) & RS(out)	LDPC or BCC	LDPC(in) & RS(out)	LDPC(in) & RS(out)
3	LDPC or BCC	LDPC or BCC	LDPC or BCC	LDPC(in) & RS(out)	LDPC(in) & RS(out)	LDPC or BCC	LDPC(in) & RS(out)	LDPC(in) & RS(out)
4	LDPC(in) & RS(out)	LDPC(in) & RS(out)	CFP/HARQ	LDPC(in) & RS(out)	LDPC(in) & RS(out)	LDPC or BCC	LDPC(in) & RS(out)	LDPC(in) & RS(out)
5	LDPC(in) & RS(out)	LDPC(in) & RS(out)	CFP/HARQ	CFP/HARQ	CFP/HARQ	LDPC(in) & RS(out)	CFP/HARQ	CFP/HARQ
6	LDPC(in) & RS(out)	LDPC(in) & RS(out)	CFP/HARQ	CFP/HARQ	CFP/HARQ	LDPC(in) & RS(out)	CFP/HARQ	CFP/HARQ
7	LDPC(in) & RS(out)	LDPC(in) & RS(out)	CFP/HARQ	CFP/HARQ	CFP/HARQ	LDPC(in) & RS(out)	CFP/HARQ	CFP/HARQ

Remark: LDPC(in) and RS(out) means concatenated code with LDPS as inner code and Reed-Solomon code as outer code.

6.4 Evaluation of Channel Codes Assigned Corresponding to Different QoS Priority Levels

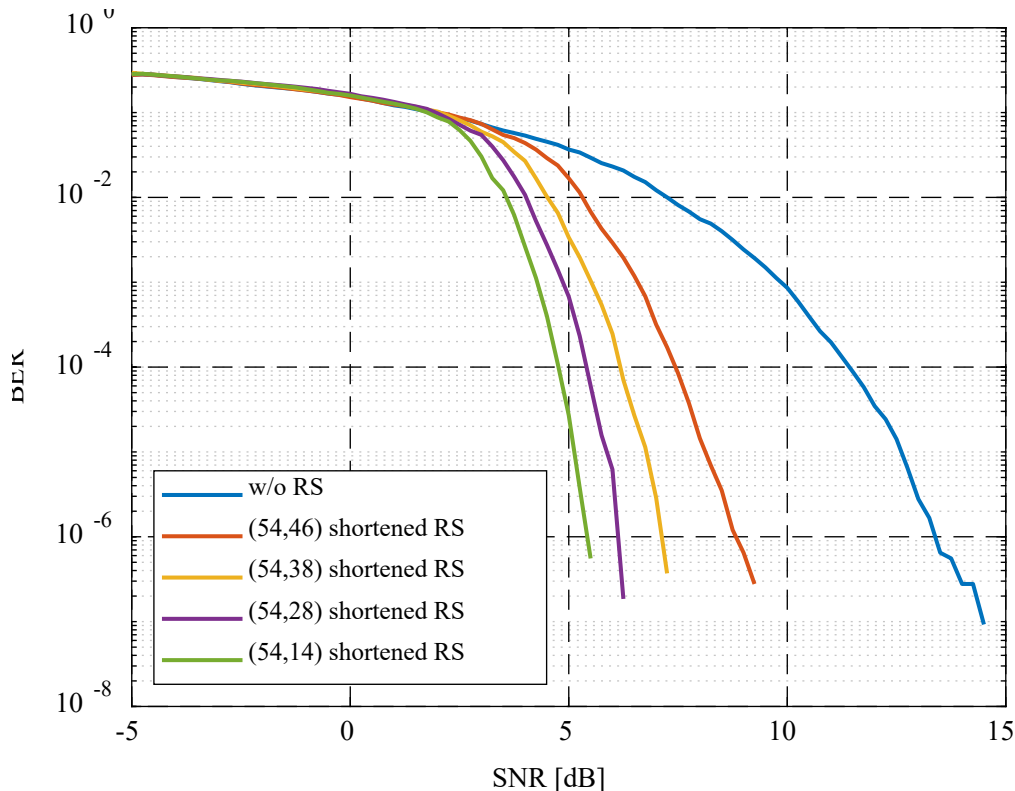

Bit error ratio of (54,46), (54,38), (54,28), (54,14) shortened RS codes and no encoding were evaluated under an AWGN channel and BPSK modulation

Performances were improved as the coding rate decreased

LDPC simulator is currently checked and will be combined with the RS simulator

6.5 Performance Evaluation of Channel Coding with Interleaver

- Concatenated code
 - Outer code : Two shortened RS codes
 - Inner code : LDPC code
- BPSK modulated

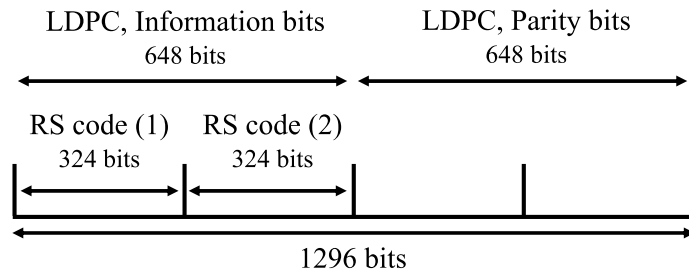

Configuration of concatenated code

- Shortened RS code
 - 1 symbol = 6 bits
 - Codeword : 63 symbols
 - Shortened symbol : 9 symbols
 - Code length : $(63 - 9) \times 6 = 324$ bits
 - Coding rate : 46/54, 38/54, 28/54, 14/54
- LDPC code
 - Code length : 1296 bits
 - Coding rate : 1/2
 - Number of iteration : 30
 - Decoding algorithm : Min-sum algorithm

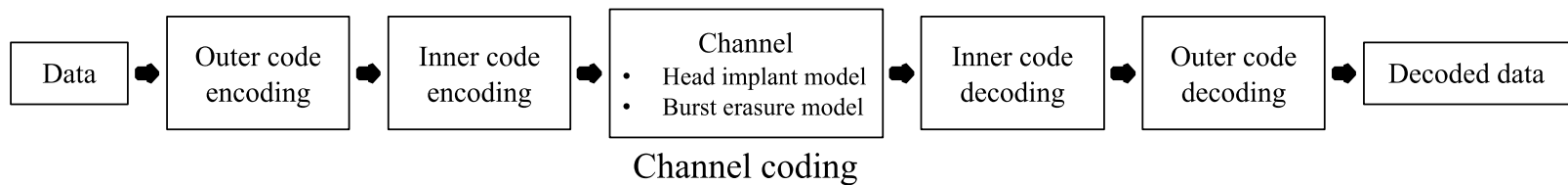

6.5 Effect of interleaving on BER performance

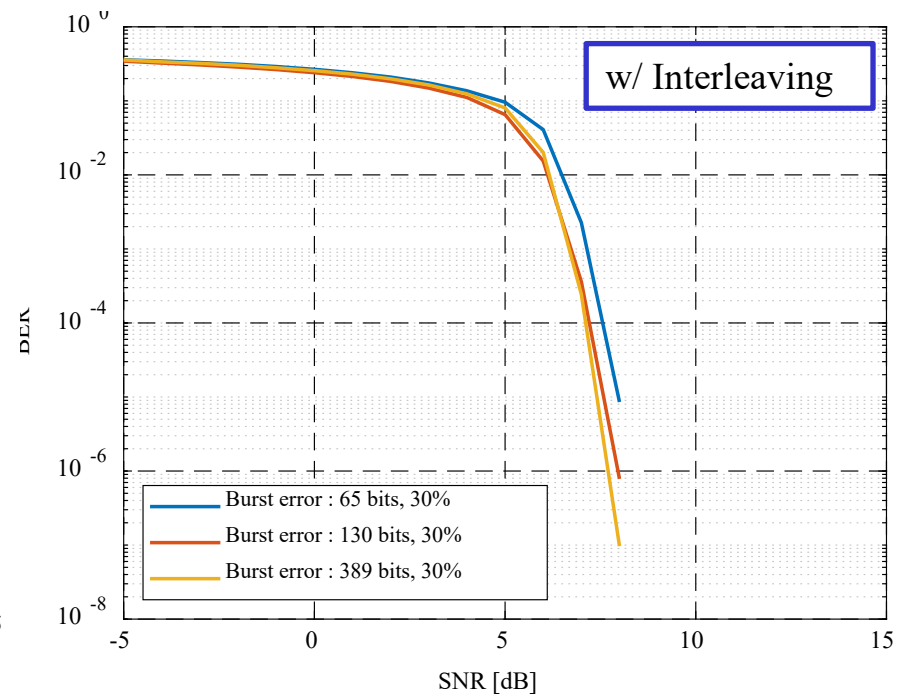
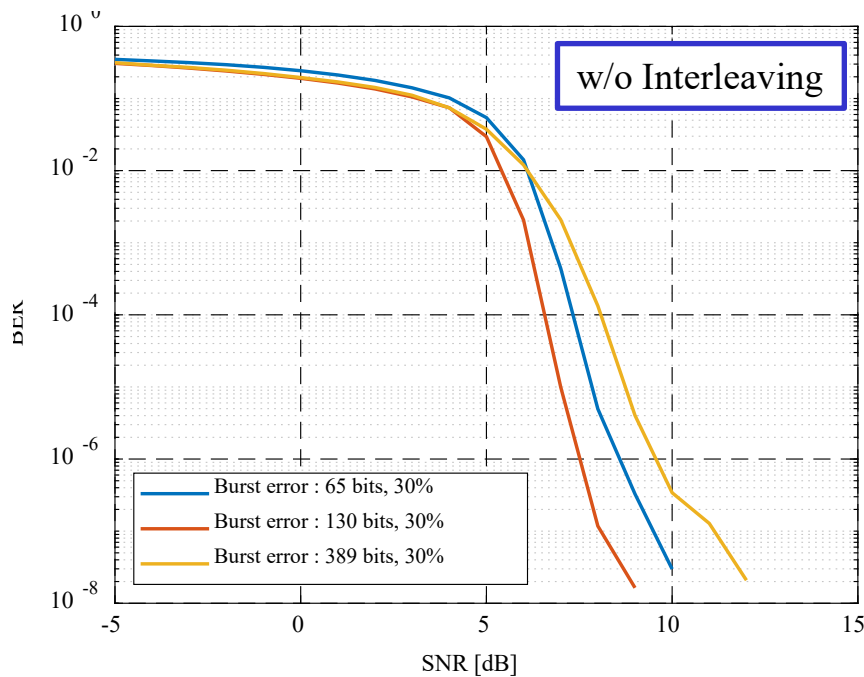

- Modulation: BPSK
- Interleaver type: Random
- Channel: AWGN + burst erasure channel

6.5 Effect of interleaving on BER performance

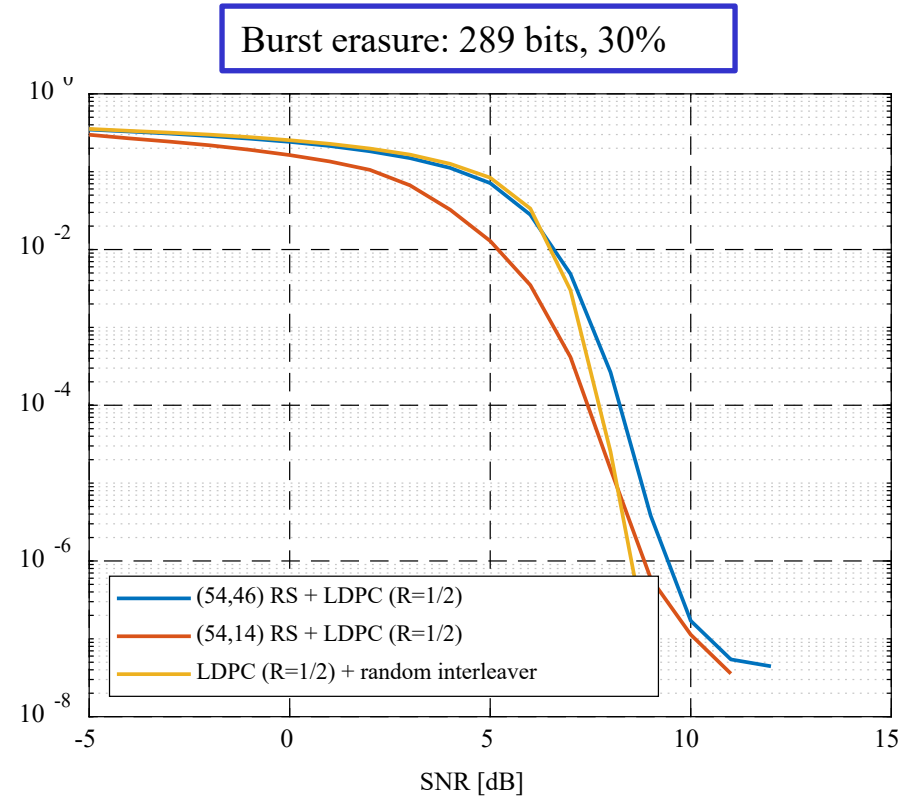
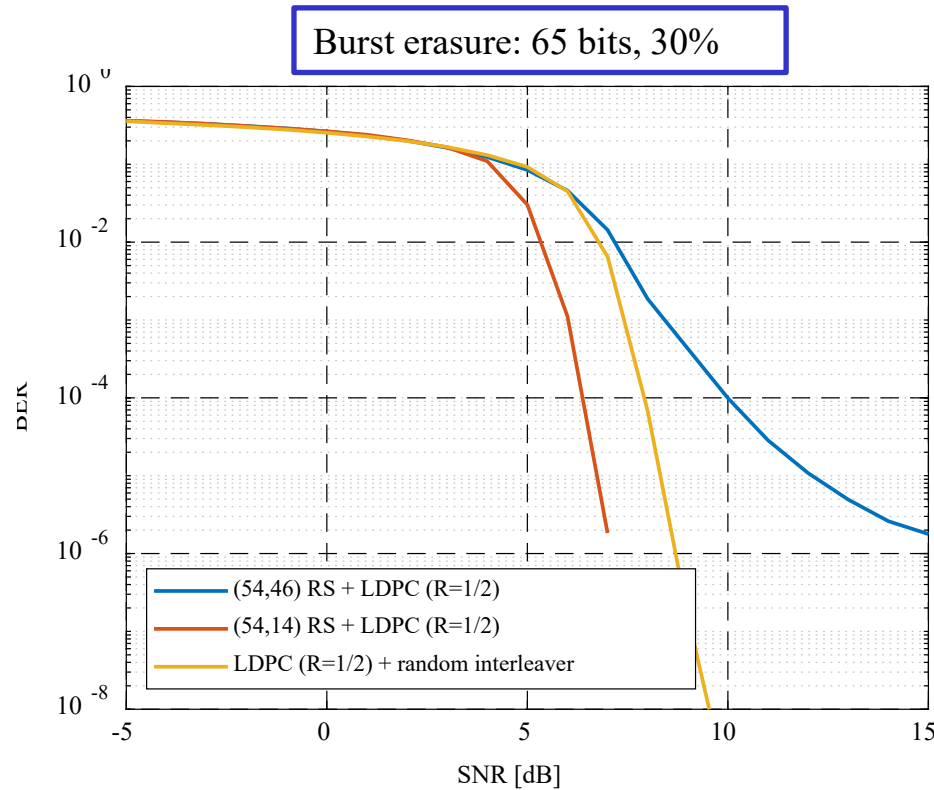

- Modulation: BPSK
- Interleaver type: Random
- Channel: AWGN + burst erasure channel

6.5 Effect of interleaving on BER performance

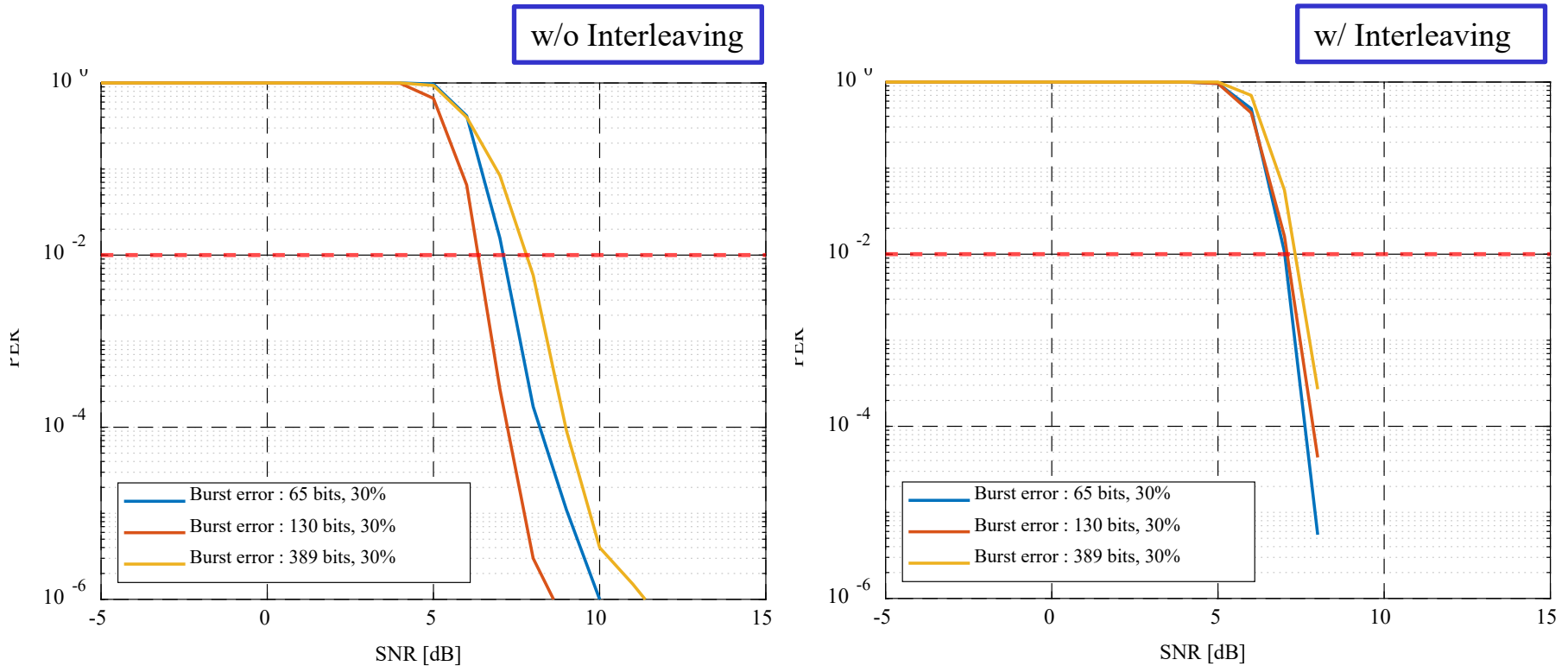

- Modulation: BPSK
- RS(54, 28) + LDPC(R=1/2)
- Channel: AWGN + burst erasure channel

7. PHY Intra and Inter System Interference among BAN and Other PANs

◆ *Inter-user interference*

- IR-UWB uses the same pulse as all users signal in the same standard.
- **Other users** signal and/or the **other network** signal would be interference.

◆ *Inter-system interference*

- Interference from the other wireless system using overlapped frequency band. ⇒ **Unknown**

* 802.11a (wi-fi) (5GHz) overlaps

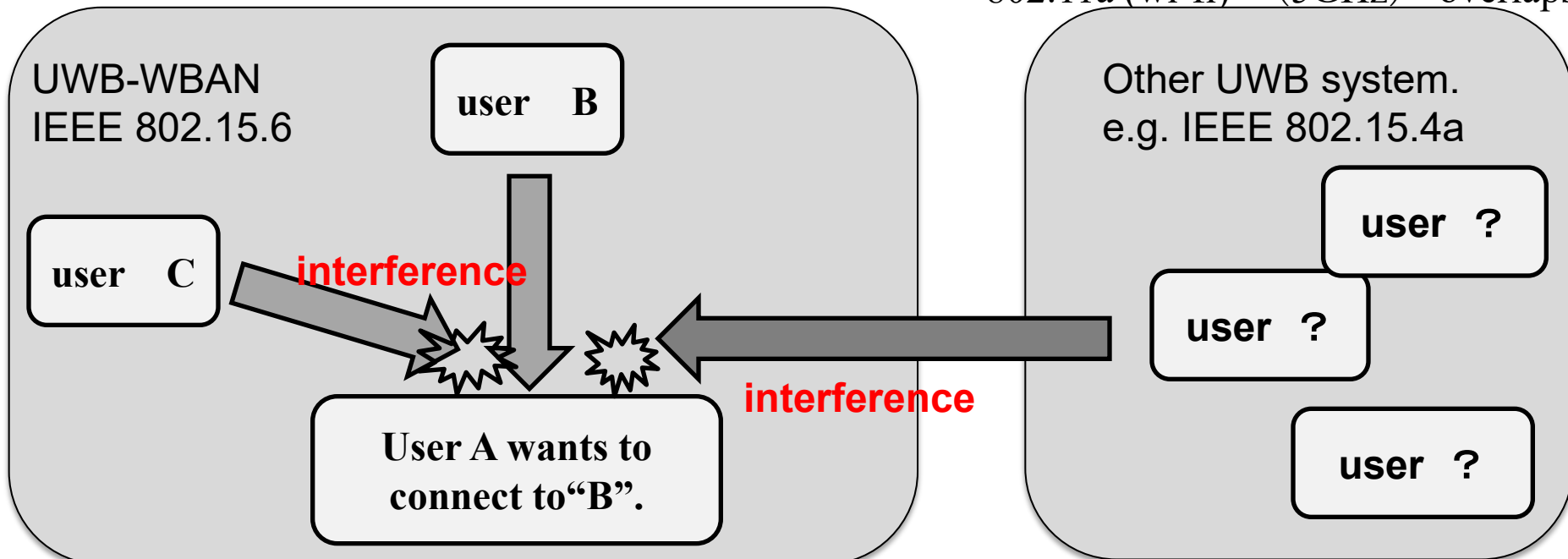

7.1 Approach for Intra and Inter System Interference among BAN and Other PANs

- **Sparate** and **Recognize** each interference from different source.
 - * Apply suitable interference mitigation method according to source of interference.
- Using both of Spatial and Temporal signal processing.

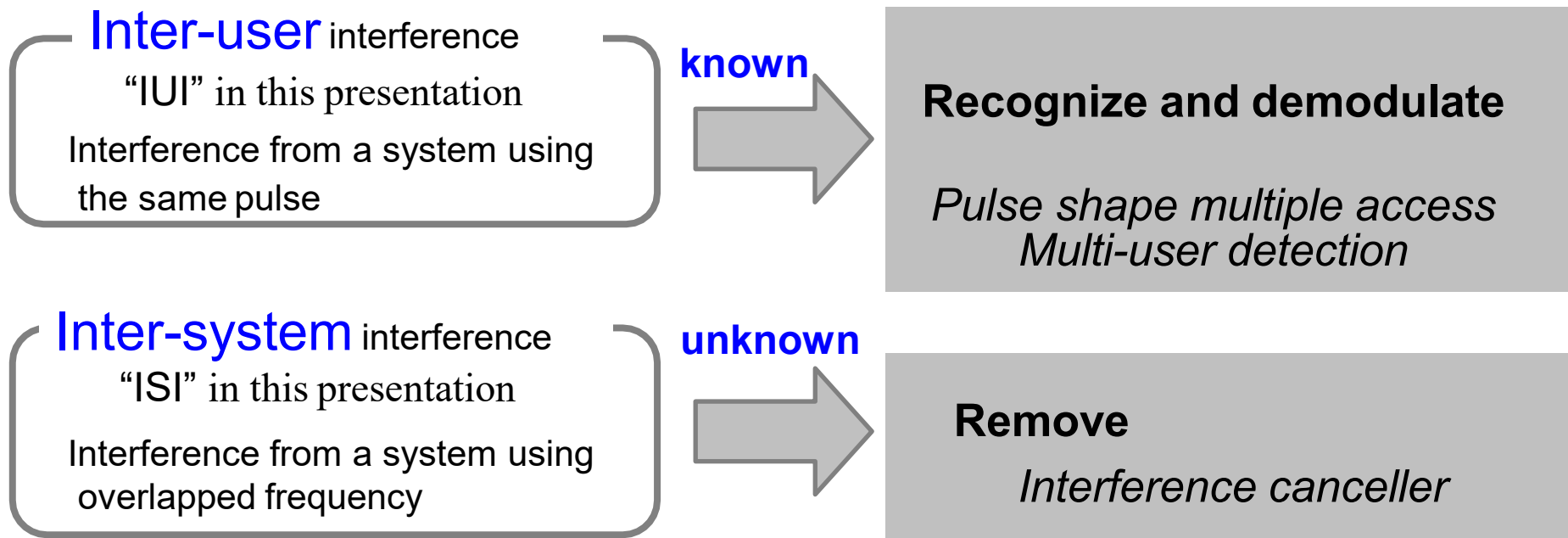

7.1.1 Time Domain Interference Mitigation

● OMF ; orthogonal matched filter

- ◆ consists a matched filter (MF_1) and MF Group (MFG)
- ◆ Tap coefficients of MF_1 are the same as sequence of desired signal.
- ◆ Coefficients of MF_1 and each MF_k that constituting MFG are **orthogonal**.
- ◆ Desired signal does not through $MF_{2\sim K-1}$ because orthogonality.
→ **only interference can through.**
- ◆ **MFG makes replica of interference signal by lenear combination with weight vector w of linear combiner; LC.**
- ◆ Subtract interference replica from the output of MF_1 .

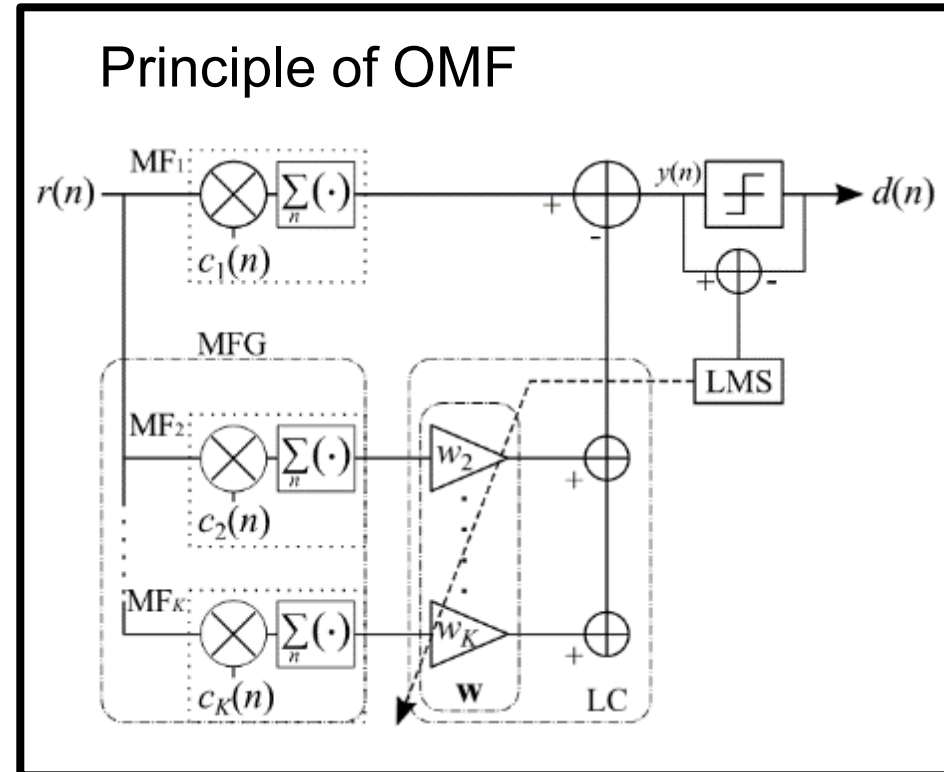

OMF can remove interference without any pre-knowledge of interference.

7.1.2 Space Domain Interference Mitigation

● TDL-AA ; Tapped delay line array antenna

(Tapped delay line array antenna)

- ◆ Array antenna by using multiple antenna elements and tapped delay line.
 - ◆ Each antenna branch has coefficients.
 - ◆ Transfer function of this antenna has parameters of signal incoming **angle; θ** and **frequency; ω** .
- ⇒ **h a s characteristics of both of spatial and time domain.**

$$\tau_n = n \frac{d}{c} \sin \theta,$$

$$y(t) = \exp(j\omega t) \sum_{n=0}^{N-1} \sum_{m=0}^{M-1} \exp(-j\omega(\tau_n + mT_0)) w_{n,m},$$

$$= \exp(j\omega t) \times H(\theta, \omega),$$

$$H(\theta, \omega) = \sum_{n=0}^{N-1} \sum_{m=0}^{M-1} w_{n,m} \exp(-jm\omega T_0) \exp(-jn\omega \frac{d}{c} \sin \theta).$$

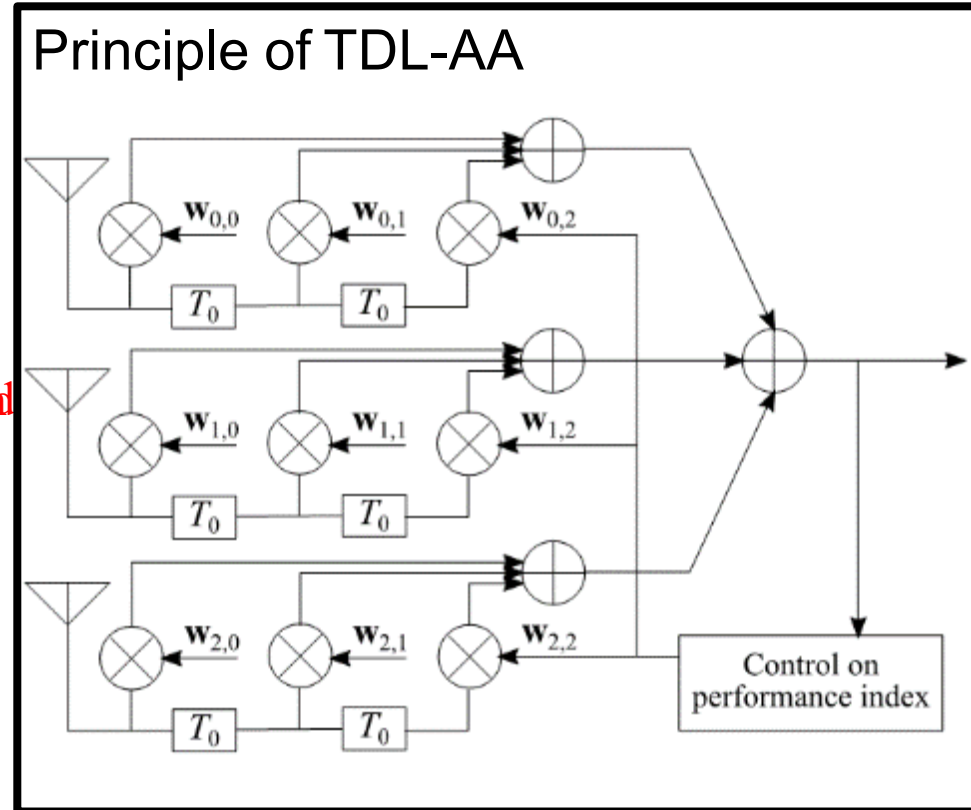

TDL-AA can work as interference canceller on both of time and space domains

7.1.3 Interference Mitigation among Other Radios

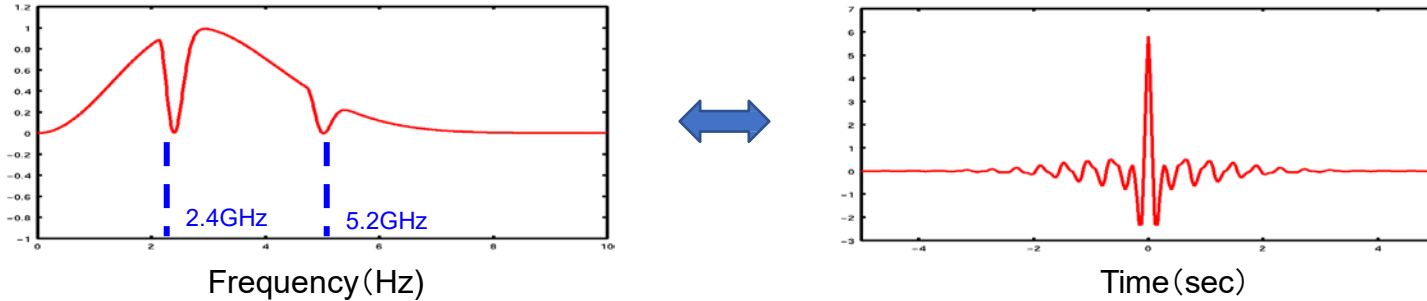

(a) Time Waveform of Pulse (right figure) and its Frequency Spectrum with notches in 2.4 and 5.2GHz for WLAN (left figure)

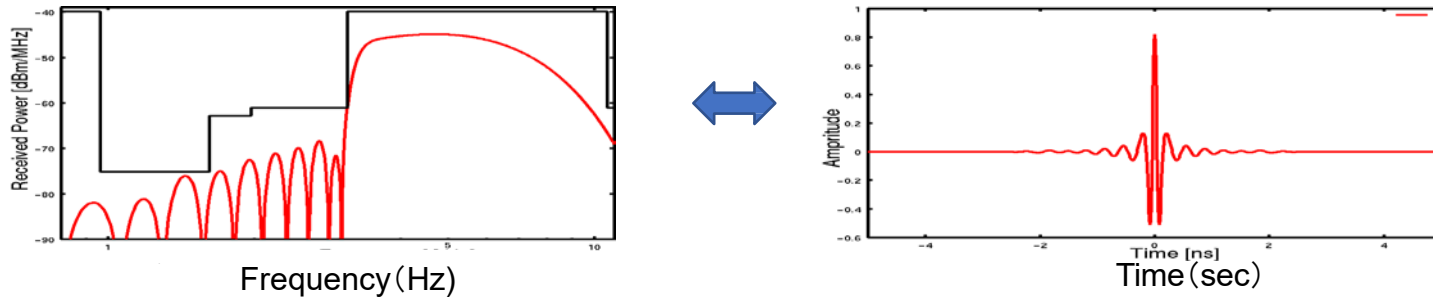

(b) Time Waveform of Pulse (right figure) and its Frequency Spectrum satisfying spectrum mask (left figure)

Ref. R.Kohno, H.Zhang, H.Nagasaka, "Ultra Wideband impulse radio using free-verse pulse waveform shaping , **Soft-Spectrum adaptation**, and local sine template receiving," doc.: IEEE

7.1.4 Integrated Terminal to Avoid Mutual Interference in case of overlaid coexisting BAN and other Radios such as UWB-BAN and 4G/5G

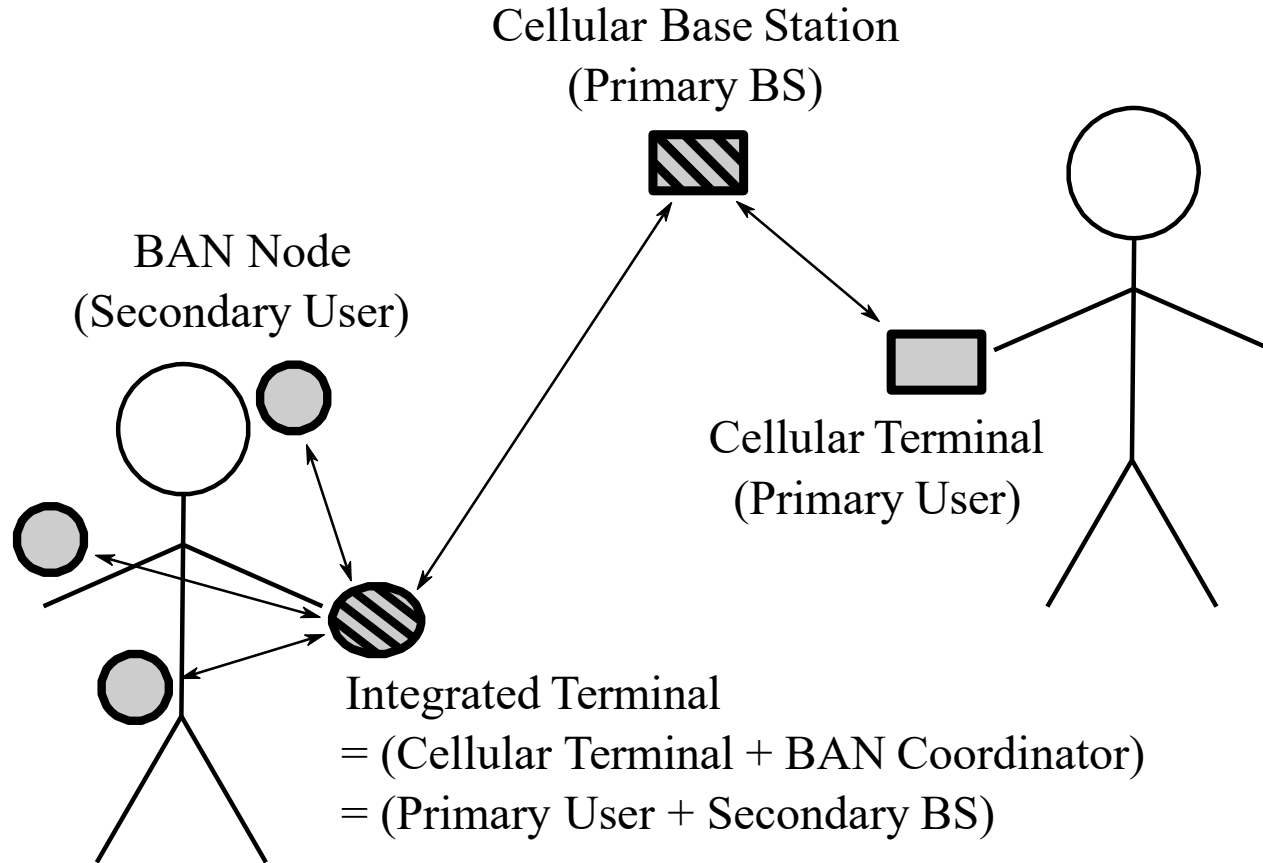

M. Kim, T.Kobayashi, C.Sugimoto, R Kohno, "Transmission Power Control of UWB -WBAN for Avoidance of Interference to Cellular Networks Using Integrated Terminal for Both Networks," International Journal of Computer Science and Telecommunications, ISSN 2047-3338 (Online) , Vol. 11, Issue 02, pp.8-15, March 2020

7.2 Coordinator-to-Coordinator (C2C) Ranging and Communication for Monitoring Coexistence Status in Multiple BANs

This specification is for ranging among coordinators of coexisting multiple BANs. To identify status of overlaid radio coverage range of multiple 15.6ma BANs, ranging capability of BAN coordinators is applied in option because two-way ranging (TWR) technology of UWB PHY can perform more accurate ranging among coordinators of approaching or leaving one another than RSSI technology using received power of narrowband PHY as shown Figure 2.

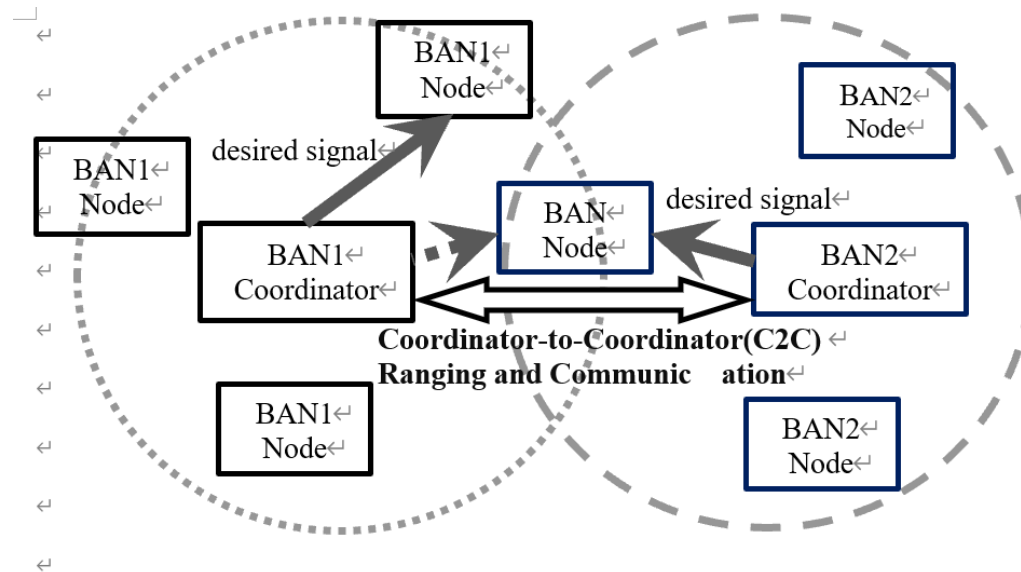

Figure 2 —Coordinator-to-Coordinator(C2C) Communication and Ranging

7.2 Coordinator-to-Coordinator (C2C) Ranging and Communication for Monitoring Coexistence Status in Multiple BANs

C2C ranging can enhance dependability of BANs by authentication of desired and undesired coordinators in environment of coexistence among multiple BANs.

C2C ranging is an optional service, but its feasible implementation may be performed by the manner of IEEE Std 802.15.4z and its amendment IEEE Std 802.15.4ab using UWB PHY [B20][B21]. In IEEE Std 802.15.6ma MAC, Group BAN coordinator periodically broadcasts beacons for seeking neighboring BAN coordinators for C2C ranging. Once group BAN coordinator to other BAN coordinators link has been established, TWR based on UWB packets proceeds C2C ranging to identify coordinators of approaching or leaving one another.

CWC communication or negotiation performs management of access controlling packets between a coordinator to nodes within each BAN and among coexisting multiple BANs. Its detail is referred in [B45][B46].

[B20] IEEE Std 802.15.4z CAD: <https://mentor.ieee.org/802.15/dcn/18/15-18-0523-06-004z-coexistence-document-15-4z.docx>

[B21] P802.15.4ab Draft P802.15.4ab-D01

[B44] Interference Mitigation Schemes in Class 3, 5, 6, and 7 of Coexistence in TG6ma, 15-24-73-2-06ma

[B45] MAC Protocol Using Negotiation among Coordinators in Coexistence of Multiple Wireless BANs, 15-22-633-0-06a

[B46] TG15.6a Coordinator-to-coordinator communication for Body Area Networks, 15-21-582-2-06a

7.3 Application of Appropriate Sets of Preamble Codes in Cass 1 of Coexisting Multiple BANs

- The coordinator may scan all the logical channels and use the preamble code sequence with minimum received power level. The usage of preamble code sequences improves coexistence of BANs and interference mitigation as different BANs use different preamble sequences.
- Appropriate sets of preamble code sequences can avoid interference among coexisting BANs in Class 1.

7.3.1 Synchronization header

- The synchronization header (SHR) shall be divided into two parts. The first part is the preamble, intended for frame synchronization, and packet detection. The second part is the start-of-frame delimiter (SFD) as shown in Figure 153.

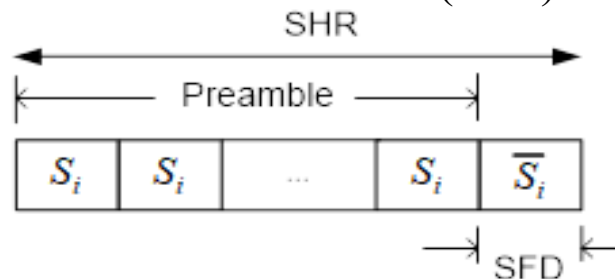

Figure 153 —Synchronization header structure

7.3.2 Preamble Codes

- Kasami sequences of length 63 shall be used to build the preamble. There are eight Kasami sequences defined in Table 125. Every Kasami sequence is indexed by C_i for $i = 1, \dots, 8$.
- The set of sequences shall be divided into two pools, where each pool has a set of four preamble sequences. The first pool (C_1 to C_4) shall be used for odd number of physical channels. The second pool (C_5 to C_8) shall be used for even number of physical channels. Therefore, four logical channels are available per physical channel.
- The coordinator may scan all the logical channels and use the preamble sequence with minimum received power level. The usage of preamble sequences improves coexistence of BANs and interference mitigation as different BANs use different preamble sequences.

Table 125 —Eight Kasami sequences of length 63

C_1	111111010101100110111011010010011100010111100101000110000 100000
C_2	000110001001001000101100011001111001100101011100011010101 010010
C_3	100011111011110001110000110111101110101110111001101000010 011001
C_4	010001000010101101011110100000100101001011001011010001001 111100
C_5	101000011110000011001001101011000000111001110010001101100 001110
C_6	110100110000010100000010001110110010000000101110100011110 110111
C_7	01101010011101111110011111100001011011100000000110100111 101011
C_8	00110110110011101001010100010101011111001001011111111011 000101

Medica Access Control Layer (MAC) Specification

8. MAC Basic Consensus

- Two channels using two UWB band channels are applied for control channel to control frames of coexisting networks and data transmission channel. **Its alternative mode is two channels or time slots for control and data transmission using a single UWB band channel.**
- IEEE802.15.6ma; revision of IEEE802.15.6-2012 focuses on enhanced dependability in data transmission and ranging according to the class 0-7 of coexistence.
 1. **Class 0&1:** New 15.6ma MAC is defined primarily to support enhanced dependability of a new 15.6ma BAN (Class 0) and multiple 15.6ma BANs (Class 1).
 2. **Class 2:** 15,6ma MAC is defined secondarily to support backward compatibility with a legacy 15.6-2012 BAN as long as enhanced dependability of a new 15.6ma BAN can be performed in Class 2.
 3. **Class 4:** 15.6ma MAC is defined to support interoperability with coexisting **15.4ab WSN/PAN in secondary** as long as enhanced dependability of 15.6ma BAN can be performed in primary in Class 4.
 4. **Class 3,5,6,7:** 15.6ma MAC is defined to support enhanced dependability of 15.6ma BAN **while mitigating interference from coexisting other radios.**
- **Hence, new 15.6ma MAC documentation must be good enough by describing mostly in Class 1 including Class 0, and Class 4 while describing a way to recognize class of coexistence and to mitigate interference in other classes.**

8.1 MAC Frame Structure

8.1.1. MSDU format in 15.6-2012

- The usual: MAC header + MAC payload + MAC footer

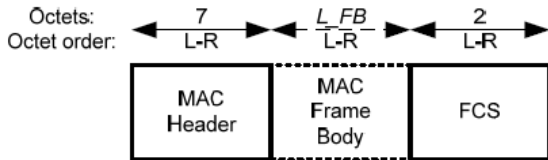

Figure 8—MAC frame format

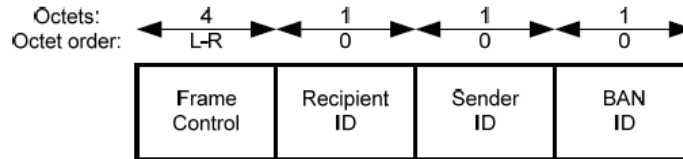

Figure 9—MAC Header format

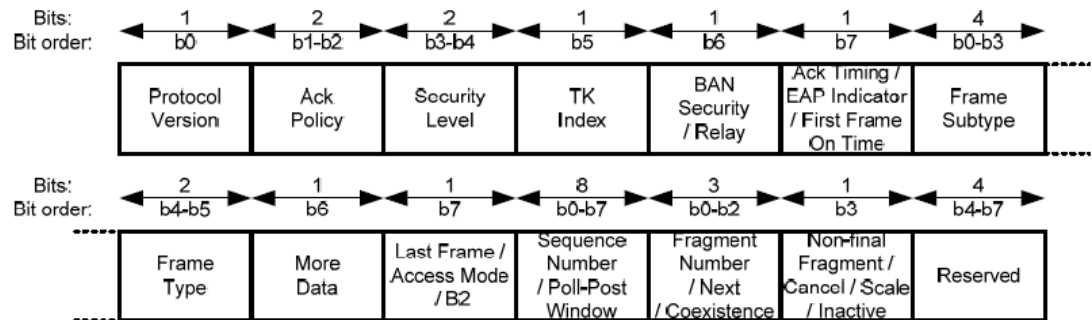

Figure 10—Frame Control format

8.1.2 15.6ma MAC

- Due to the historic background of 15.6, the MSDU format supports several MAC mechanisms (polling, CSMA, slotted Aloha, LBT), and it is up to vendors what specifically to implement.
 - However, the result was that the MAC spec is difficult to understand
- The revision 15.6ma plans to simplify the MAC mechanism under a UWB PHY:
 - LBT & slotted Aloha (CAP) and TDMA (CFP)
 - (maybe the support of an Ethertype field)
 - **Hence, the MSDU Header will change.**

8.2 MAC Protocol for Multiple BAN Environment (Class 1) # 15-22-0639 & 15-22-651-01

1.Utilizes Control Channel.

- Limits transmission privilege on Control Channel only to coordinators.
- Allows more efficient and accurate clear channel assessment by separating control frames and data frames.
- Two mandatory channels for control and data frames are required.

2.Introduces 3 Periods in Data Channel

- Network Management Period (**NMP**) for Data Beacons,
- Contention Free Period (**CFP**) for scheduled data frames,
- And Contention Access Period (**CAP**) for unscheduled data frames and node connection/disconnection.

3.Each BAN has its own contention free period while sharing superframes.

- To avoid frame collision between coexisting BANs.
- Operating procedures of some MAC functions such as BAN Creation and Superframe Transition are explained.
- The newly required fields for performing this procedure have been explained.

8.3 MAC in Class 1 for coexisting dependable BANs # 15-22-0594 & 15-22-651-01(January 2023)

1. Dependable BAN Service Classes

- Specifies three classes. Coexisting BANs will coordinates based on the BAN class.

2. Beacon Period Extension

- Allows flexible configuration of the beacon period.
- Supports large number of nodes while guaranteeing short cycle time.
- Guarantees that nodes can access the channel every cycle time.

3. Coordinator Hub and Beacon Access Phase

- Defines Beacon Access Phase (**BAP**) in the beacon period.
- Defines a coordinator hub and a leaf hub and let coordinator hub assigns beacon slots for leaf hubs.

4. Scheduled Access Extension

- Allows nodes have periodic access multiple times in a beacon period

5. Adaptive Superframe Interleaving with Adjustment and Regulation

- Negotiates the structure of beacon period among coexisting dependable BANs and regulates transmissions.

8.4 MAC Function

8.4.1 MAC Mode 1

Two UWB Bands Use for Control and Data Transmission Channels for Enhanced Dependability

According to functionality of used RF devices and modules, the following two modes of MAC function can be chosen. Primarily mode 1 is recommended for highly enhanced dependability if RF devices and modules can use two UWB bands channels while mode 2 is alternative choice if only a single UWB band channel is available.

- **MAC Mode 1:** Two channels using two UWB band channels are applied for control channel to manage frames of coexisting networks and data transmission channel.
- **MAC Mode 2:** Another alternative mode is two channels in time slots for control and data transmission using a single UWB band channel.

MAC Proposal of TG15.6ma (Revision of IEEE802.15.6-2012)

Doc.#802.15-22-0639-03-06a (May 2023)

MAC Protocol Proposal for Multiple BAN Environment (Level 1) **Class 1**

May 15th, 2023

Minsoo Kim, Takumi Kobayashi, Marco Hernandez,
and Ryuji Kohno
Yokohama National University(YNU),
YRP International Alliance Institute(YRP-IAI)

Introduction

- In this draft proposal, we are focusing on ensuring high dependability in scenarios where multiple Body Area Networks (BANs) are operating together.
- One of our key strategies is to allocate specific time slots (or periods) to each BAN, which helps to prevent frame collisions, even among different BANs.
- To achieve this, we are proposing the use of a dedicated channel for exchanging network control frames and coordinator-to-coordinator frames.
- This strategy will not only enable efficient time slot allocation to each BAN, but also allow for more precise Clear Channel Assessment (CCA), especially in dense environments.
- It is also crucial to maintain backward compatibility and ensure coexistence with devices based on the original standard. We would also like to consider ways to ensure this.

Dedicating a channel for control frames

- In the original IEEE Std 802.15.6-2012, both network control and data exchange happen on the same channel, with different frame types distinguishing between the two.
- In our proposal, we suggest dedicating one channel exclusively for the exchange of network control frames. There are a few key advantages to this approach:
 - 1. Efficient Clear Channel Assessment (CCA):** With just one channel to monitor, CCA can be conducted more efficiently.
 - 2. Reduced Control Frame Collisions:** By transmitting control frames on a less congested channel (where data frames are absent), we can significantly reduce the likelihood of frame collisions.
 - 3. Enhanced Dependability:** Devices designed for an extra level of dependability may be able to utilize this dedicated control channel, thereby enhancing the overall reliability of the network.

Channel configuration

Band group	Channel number	Central frequency (MHz)	Bandwidth (MHz)	Channel attribute in 802.15.6-2012	Channel attribute for the revision	
					Control	Data
Low band	0	3494.4	499.2	Optional	Control	Optional
	1	3993.6	499.2	Mandatory	Control/Data	Mandatory
	2	4492.8	499.2	Optional		Optional
High band	3	6489.6	499.2	Optional	Control/Data	Optional
	4	6988.8	499.2	Optional		Optional
	5	7488.0	499.2	Optional	Control	Optional
	6	7987.2	499.2	Mandatory	Control/Data	Mandatory
	7	8486.4	499.2	Optional		Optional
	8	8985.6	499.2	Optional		Optional
	9	9484.8	499.2	Optional		Optional
	10	9984.0	499.2	Optional		Optional

- In the original IEEE Std 802.15.6-2012, one specific channel is designated as mandatory for each band group.
- To maintain backward compatibility with the original standard, the mandatory channel configuration remains unchanged in the proposed revision.
- Additionally, in the proposed revision, one channel is designated as the control channel, which can be utilized as a common channel shared by multiple systems.

Frame assignments for Control/Data Channels

Channels	Periods	Frames (draft)	
		From coordinators	From nodes
Control	n/a	<ul style="list-style-type: none"> Control Beacon Coordinator-to-coordinator 	Not allowed
Data	Network Management	<ul style="list-style-type: none"> Data Beacon 	
	Contention Free	<ul style="list-style-type: none"> Scheduled Data 	<ul style="list-style-type: none"> Scheduled Data
	Contention Access	<ul style="list-style-type: none"> Connection Assignment Disconnection Response Unscheduled Data 	<ul style="list-style-type: none"> Connection Request Disconnection Notification Unscheduled Data

- The frame assignments have been developed to account for hardware limitations between the coordinator and the nodes, including processing power, transmitting power, memory capacity, and energy efficiency.

Control Channel

- Only coordinators are allowed to transmit on the control channel (C-Channel).
- The control channel does not follow a time slot structure.
 - Due to the mobility of BANs, there is a possibility that BANs or groups of BANs with different synchronization timings may come across each other.
 - Therefore, it is reasonable to design MAC protocol with the assumption that reliable synchronization between multiple BANS is not possible.
 - This is particularly important when considering the interoperability of BANs with other UWB systems.

Control Channel (cont.)

- A coordinator is required to transmit a control beacon frame (C-Beacon) on the control channel (C-Channel) at regular intervals of T_C seconds.
 - Prior to emitting the first C-Beacon, the coordinator must perform Clear Channel Assessment (CCA) to ensure the channel is clear.
 - The C-Beacon Period, T_C , is randomly selected by the coordinator within the range of $T_{C,\min}$ to $T_{C,\max}$.

Why is the C-Beacon Period Random?

- When all coordinators transmit their C-Beacons at the same interval, a collision between C-Beacons will persist indefinitely, causing ongoing interference.
- However, by assigning each coordinator a different interval, collisions can be minimized or eliminated.
- It is desirable to choose intervals that are relatively prime or have a large greatest common multiple, as this reduces the likelihood of future collisions and enhances overall network performance.

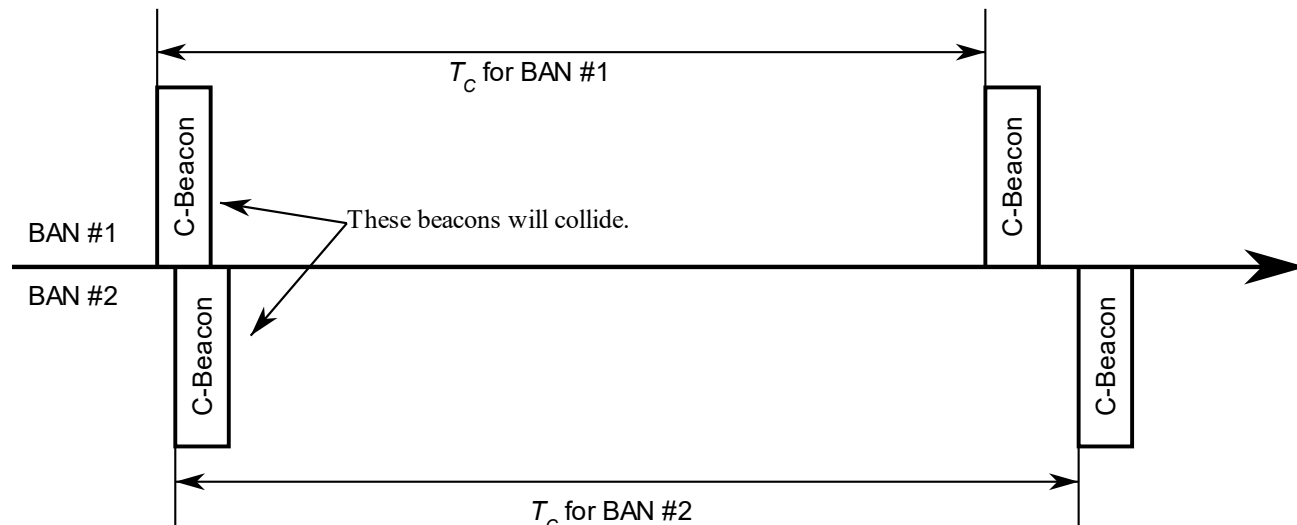

Data Channel

- Both coordinators and nodes have the capability to transmit on the data channel (D-Channel).
- The time axis in a D-Channel is divided into superframes, each with a fixed duration of T_D seconds.
- Within each superframe, the time axis is further divided into time slots, each with a fixed duration of T_S seconds.
- The superframe consist of four distinct periods:
 - Network Management Period (NMP): This period consist of N_{NMP} time slots, which are dedicated to transmitting network management frames, such as data beacons.
 - Contention Free Period (CFP): This period consist of N_{CFP} time slots, which are reserved for transmitting scheduled frames.
 - Contention Access Period (CAP): This period consist of N_{CAP} time slots, which are used for transmitting unscheduled frames.
 - Inactive Period: During this period, no frames are transmitted.

Data Channel (cont.)

- Each coordinator is required to select one D-Channel.
- To achieve higher dependability, a coordinator may support the use of multiple D-Channels simultaneously.
- Within each superframe of the selected D-Channel, a coordinator transmits a data beacon frame (D-Beacon) on a single time slot from the Network Management Period (NMP).

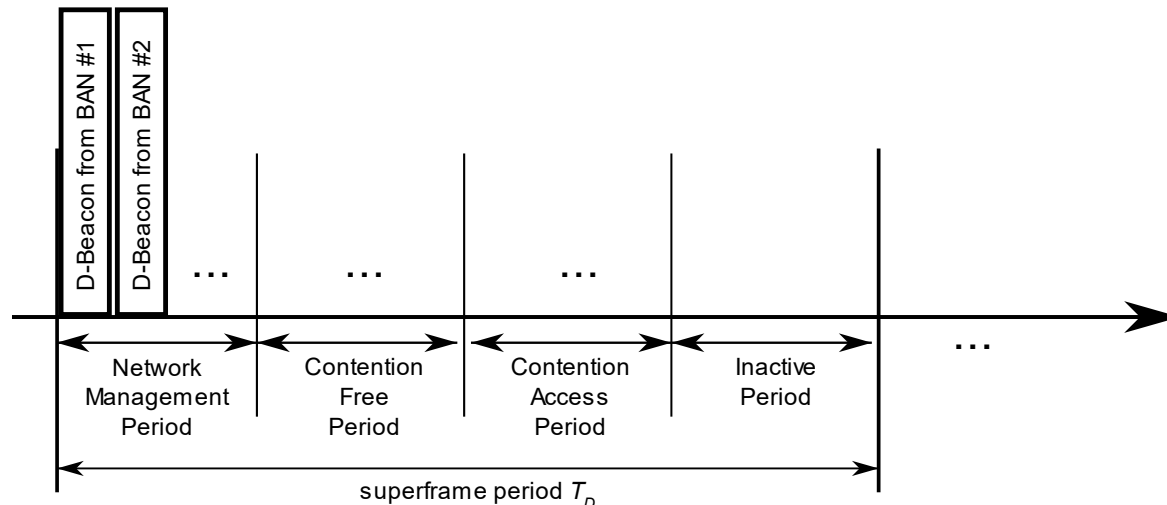

MAC Functions

- BAN Creation
- Superframe transition due to proximity of BAN piconets
- Node Connection/Disconnection
- Channel access
 - Contention Free Period – TDMA
 - Contention Access Period – Slotted aloha

BAN Creation

- **Neighbor BAN Detection:** The coordinator monitors the C-Channel to identify neighboring BANs and determine their presence.
- **BAN ID Selection:** The coordinator selects an available BAN ID that is not currently in use by neighboring BANs to ensure uniqueness within the network.
- **Data Channel (D-Channel) Selection:** The coordinator chooses a suitable D-Channel for communication. D-Channel Occupancy Indexes obtained from neighboring BAN's C-Beacons can be used to determine which D-Channel to use.
- **D-Channel Synchronization:** If other BANs are using the same D-Channel, the coordinator synchronizes to the superframe of the BAN(s) already using that D-Channel.

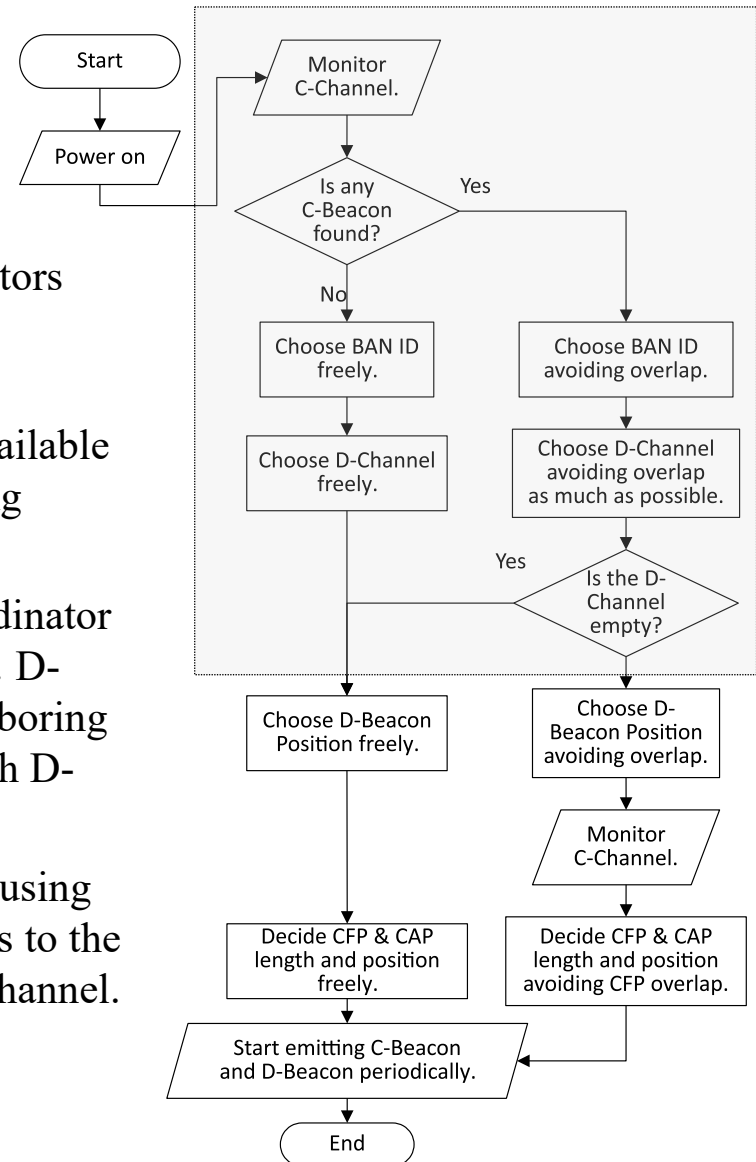

BAN Creation (cont.)

- D-Beacon Position Selection:** The coordinator selects a specific position for the D-Beacon transmission within the Network Management Period (NMP) of the superframe. It ensures that the chosen position does not overlap with neighboring BANs using the same D-Channel.
- Periodic Control Beacon (C-Beacon) Transmission:** The coordinator transmits Control Beacons periodically on the C-Channel. The C-Beacon includes essential information such as the BAN ID, D-Channel number, and D-Beacon Position in NMP.
- Periodic Data Beacon (D-Beacon) Transmission:** The coordinator transmits Data Beacons periodically on the D-Channel. The D-Beacon provides slot numbers indicating the start of the Contention Free Period (CFP) and the Contention Access Period (CAP) within each superframe.

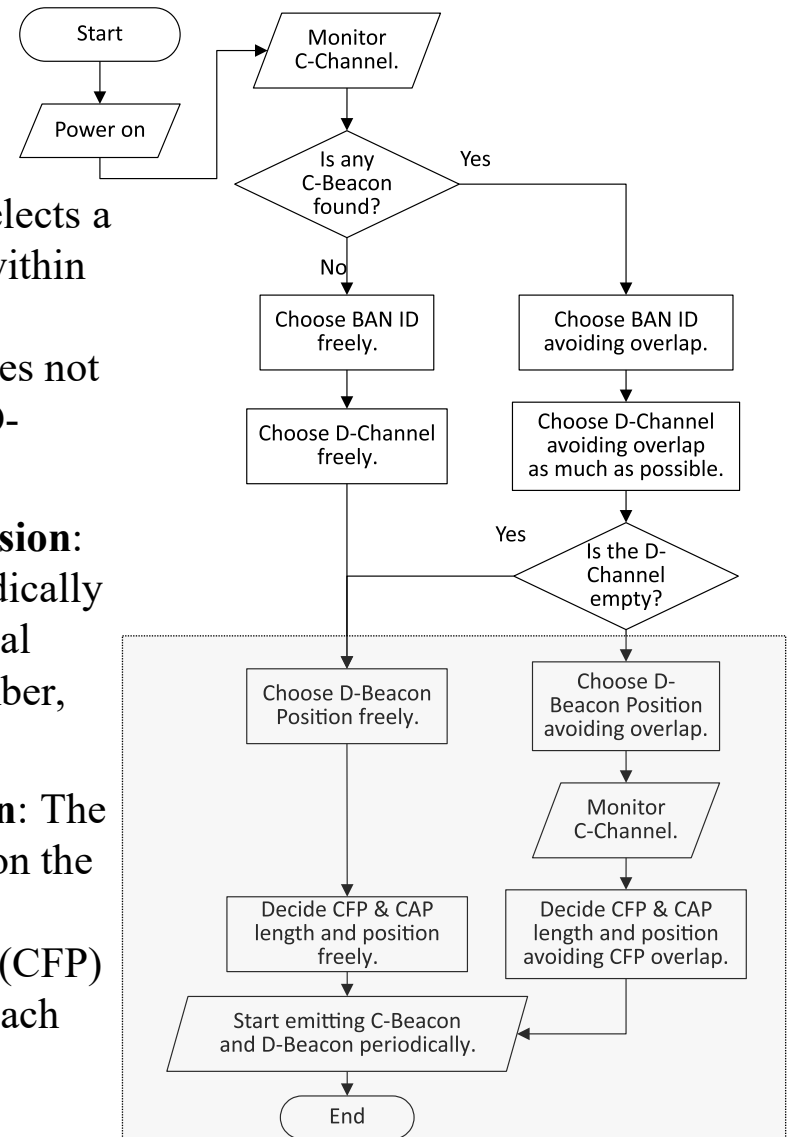

Superframe transition due to proximity of BAN piconets

- As BANs are mobile, it is possible for multiple BANs that have started independently to come into close proximity with each other.
- Since these BANs are likely using different superframes, their frames will interfere each other, causing performance degradation.
- To avoid this interference, BANs located in close proximity must transition to using common superframes.

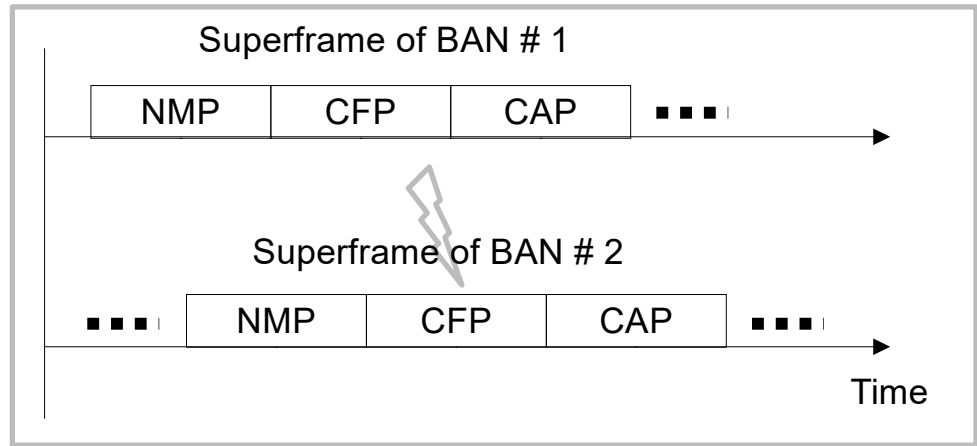

After superframe transition

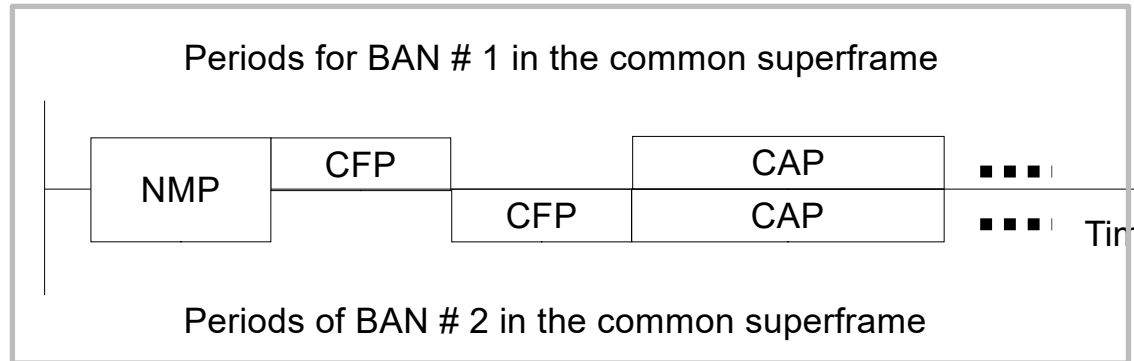

Superframe transition due to proximity of BAN piconets (cont.)

- A **coordinator** continuously monitors the C-Channel to detect neighboring BANs.
- When a **coordinator** receives a Control Beacon (C-Beacon) with a different **Superframe Reference BAN ID** value and a **Superframe Priority Index** greater than its own, it indicates that a new BAN is nearby.
- In such cases, **the coordinator** must transition to using the superframe of **the newly met BAN** to avoid interference and ensure efficient communication.

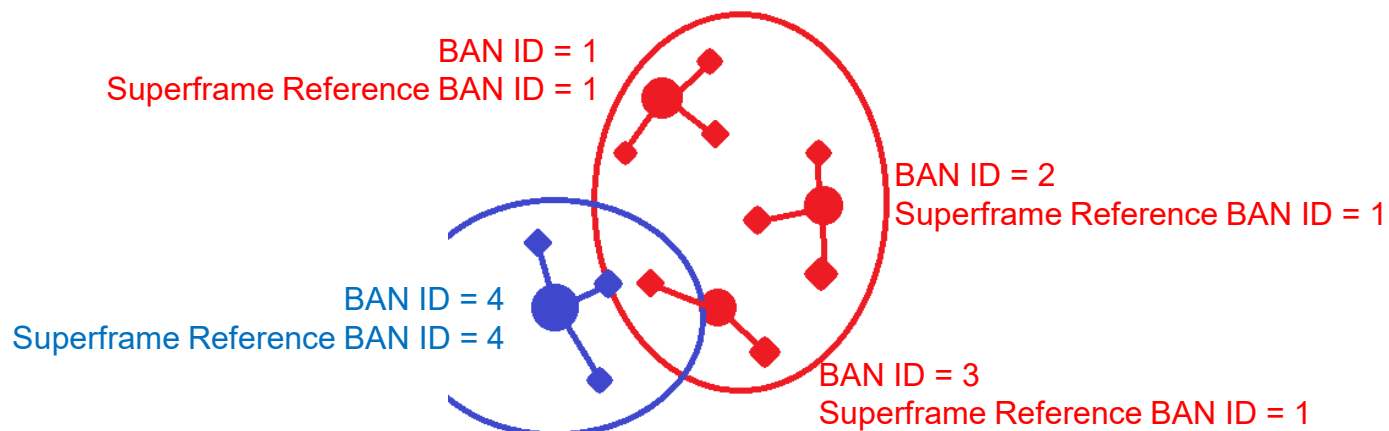

Superframe transition due to proximity of BAN piconets (cont.)

- **The Superframe Priority Index** is used to determine which BAN should continue using its current superframe and which BAN should transition to the superframe of another BAN when multiple BANs come into close proximity.
 - The index should be defined in a way that allows BANs with many nodes of high priority to maintain their superframes, while BANs with lower priority nodes can transition to other BAN's superframe.

- **Fallback Mechanism:** In scenarios where a BAN with a low Superframe Priority Index fails to receive the C-beacon of another BAN, interference cannot be avoided due to the inability to perform superframe transition.
 - To address this situation, implementing a fallback mechanism allowing high-priority BANs to initiate superframe transition would be advantageous.

Node Connection/Disconnection

- The node monitors the C-Channels to acquire a C-Beacon, which provides essential information.
- By receiving the C-Beacon, the node can obtain the BAN ID, D-Channel number, and D-Beacon Position for further communication.
- The node also monitors the D-Channels to acquire a D-Beacon, which provides details about the positions of Contention Free Period (CFP) and Contention Access Period (CAP).
- During the CAP, the node initiates the Connection Request (C-Request) frame using the Contention Access procedure.
- Upon successful reception of the C-Request frame, the coordinator responds by transmitting
 - an Acknowledgement,
 - and a Connection Assignment (C-Assignment) frame in the next available time slot.
- The C-Assignment frame provides information of the allocated resources to the node, including the number of time slots allocated, and the node's allocated Node ID.

Fields in Control Beacon

- **BAN ID**
 - This is a unique identifier assigned to each Body Area Network (BAN).
 - It is used to distinguish between BANs operating in the vicinity and facilitate communication between them.
- **D-Channel number**
 - This refers to the specific channel utilized for data transmission within a BAN.
 - Each BAN is assigned a particular D-Channel number to avoid interference with other BANs and enable efficient communication.
- **D-Beacon Position in Network Management Period (NMP)**
 - This indicates the specific time slot within the NMP where the D-Beacon, which provides network management information, is transmitted.
- **D-Channel Occupancy Index**
 - This index is a measure used to inform neighboring BANs about the congestion level of the D-Channel.
 - It provides an indication of how busy the channel is, helping BANs make informed decisions regarding D-Channel selection.

Fields in Control Beacon (cont.)

- **The Superframe Reference BAN ID**
 - This serves the purpose of informing neighboring BANs about the BAN with which they share the same superframe.
 - BANs that share superframes should have the same Superframe Reference BAN ID, allowing synchronization and coordinated operation within the shared superframe.
- **The Superframe Priority Index**
 - This is an index used to determine the priority of a BAN in relation to other BANs when multiple BANs come into proximity.
 - It enables the orderly transition of superframes, ensuring that BANs with higher priority can maintain their superframes while lower-priority BANs transition to other BAN's superframes.

Fields in Data Beacon

- **Position of Contention Free Period (CFP)**
 - This refers to the specific time slots within the superframes where the Contention Free Period occurs.
 - The CFP is a dedicated period during which scheduled frames are transmitted without contention.
 - To ensure coexistence and minimize interference among coexisting BANs, the position of the CFP may vary between BANs.
 - By assigning different CFP positions, BANs can have non-overlapping CFPs, allowing for interference-free transmission of scheduled frames.

Fields in Data Beacon (cont.)

- **Position of Contention Access Period (CAP)**
 - This refers to the specific time slots within the superframes where the Contention Access Period occurs.
 - The CAP is a period during which unscheduled frames are transmitted using the slotted aloha access mechanism, where nodes contend for access to the channel.
 - The specific position of the CAP within the superframe allows nodes to know when to transmit unscheduled frames and participate in the contention process.
 - The CAP provides a mechanism for nodes to access the channel when their transmissions are not pre-scheduled during the Contention Free Period (CFP).

List of Frame Type

Channels	Periods	Frames	Sender	Receiver
Control	n/a	Control Beacon	Coordinator	Other Coordinators and Nodes
		Coordinator-to-Coordinator		Other Coordinators
Data	Network Management	Data Beacon	Coordinator	Other Coordinators and Nodes
	Contention Free	Scheduled Downlink Data	Coordinator	Specific Node
			Coordinator	Relay Node
			Relay Node	Relay Node
			Relay Node	Specific Node
		Scheduled Uplink Data	Node	Own Coordinator
			Node	Relay Node
			Relay Node	Relay Node
			Relay Node	Own Coordinator
	Contention Access	Connection Request	Node	Own Coordinator
		Connection Assignment	Coordinator	Specific Node
		Disconnection Notification	Node	Own Coordinator
		Unscheduled Uplink Data	Specific Node	Own Coordinator

Summary

- The proposed solution emphasizes the allocation of time slots to each Body Area Network (BAN) to prevent frame collisions, even when multiple BANs are present.
- It suggest utilizing a Control Channel for precise time slot allocation and improved clear channel assessment.
- The operating procedures of essential MAC functions, including BAN creation, are presented through a flowchart, along with an explanation of the required fields to facilitate the procedure.

References

- [1] 15-22-0277-04-006a, MAC ideas for BAN with Enhanced Dependability

8.4 MAC Function

8.4.2 MAC Mode 2

Two Channels in Time Slots for Control and Data Transmission Using a Single UWB Band Channel.

MAC Mode 1: Two channels in frequency bands using two UWB band channels are applied for control channel to manage frames of coexisting networks and data transmission channel.

MAC Mode 2: Another alternative mode is two channels in time slots for control and data transmission using a single UWB band channel.

Project: P802.15 Working Group for Wireless Specialty Networks

Submission Title: Proposal of control and data channels unification for 6ma MAC

Date Submitted: November 16th, 2022

Source: Minsoo Kim, Takumi Kobayashi, Daisuke Anzai, Marco Hernandez and Ryuji Kohno

Company: YRP-IAI, NIT, CWC Oulu, YNU

Address: 3-4 Hikarino-oka, Yokosuka, 239-0847, Japan

Voice: +81 46-847-5439 **Fax:** +81 46-847-5431 **E-Mail:**

Re: In response to the call for technical contributions

Abstract:

Purpose: In response to the call for technical contributions

Notice: This document has been prepared to assist P802.15.6ma. It is offered as a basis for discussion and is not binding on the contributing individual(s) or organization(s). The material in this document is subject to change in form and content after further study. The contributor(s) reserve(s) the right to add, amend or withdraw material contained herein.

Release: The contributor acknowledges and accepts that this contribution becomes the property of IEEE and may be made publicly available by P802.15.6ma.

Unifying Control and Data Channels

Control Channel

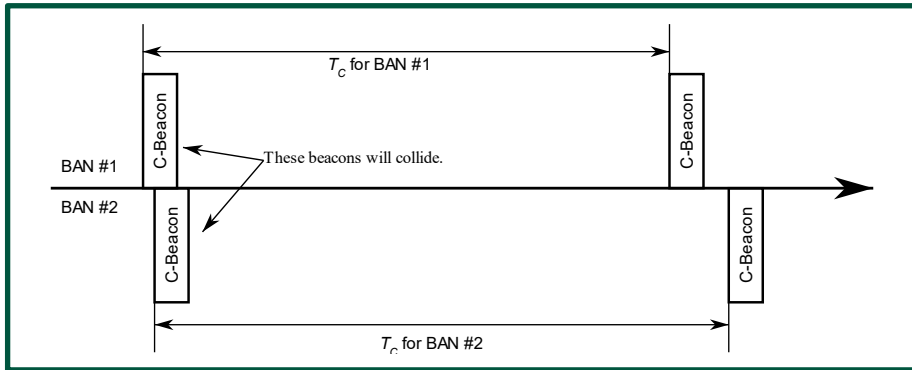

Data Channel

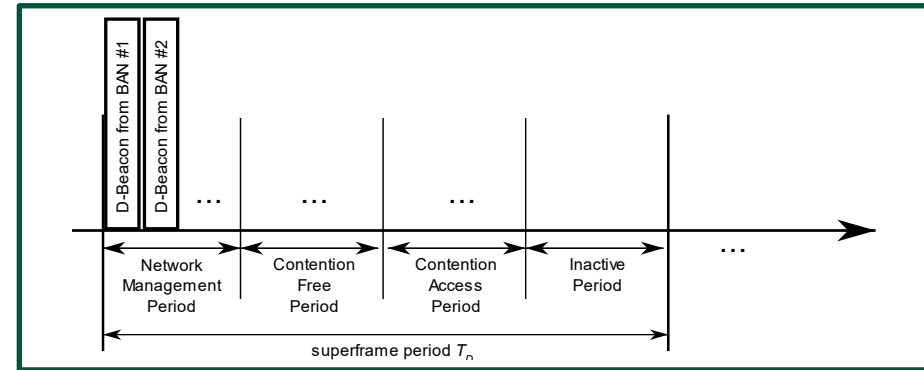

Frames for both Control Channel and Data Channels are accommodated into one single channel.

The time axis is divided into separate time periods for each frame types.

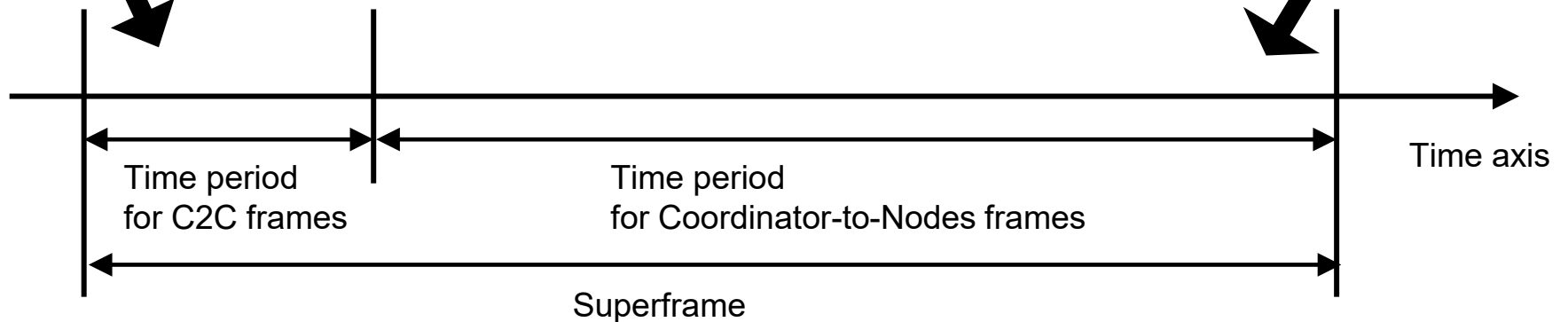

Channel usage strategy

Case of low band, according to this proposal

Band group	Channel number	Central frequency (MHz)	Bandwidth (MHz)	Channel attribute in 802.15.6-2012	Channel attribute for the revision	
Low band	0	3494.4	499.2	Optional	Control	Optional
	1	3993.6	499.2	Mandatory	Control/Data	Mandatory
	2	4492.8	499.2	Optional	Control/Data	Optional



Band group	Channel number	Central frequency (MHz)	Bandwidth (MHz)	Channel attribute in 802.15.6-2012	Channel attribute for the revision	
Low band	0	3494.4	499.2	Optional	Control/Data	Optional
	1	3993.6	499.2	Mandatory	Control/Data	Mandatory
	2	4492.8	499.2	Optional	Control/Data	Optional

- All channels carry both Coordinator-to-Coordinator Frames and Coordinator-to-Node Frames.

Motivation

- Low implementation difficulties
 - Requires only one UWB RF.
- Increase channel efficiency
 - All channel can carry Coordinator-to-Node frames.
 - Previously we had 1 control channel and n data channels.
Now we have $n+1$ channels.

Project: IEEE P802.15 Working Group for Wireless Specialty Networks

Submission Title: Overview and convergence of MAC proposals for 15.6ma

Date Submitted: July 13th, 2023

Source: Minsoo Kim, Seong-Soon Joo, Takumi Kobayashi, Anzai Daisuke, Marco Hernandez, Ryuji Kohno

Company: YRP-IAI, KPST, CWC Oulu Univ, NIT, YNU

Address: (1)79-5 Tokiwadai, Hodogaya-ku, Yokohama, 240-8501 Japan,
(2) YRP1 Bldg., 3-4 HikarinoOka, Yokosuka-City, Kanagawa, 239-0847 Japan

Voice:[+81-90-5408-0611] **E-Mail:**[minsoo@minsookim.com, kobayashi-takumi-ch@ynu.ac.jp, marco.hernandez@ieee.org, kohno@ynu.ac.jp, ssjoo@etri.sci.kr]

Re: In response to call for proposal

Abstract: Overview and convergence of MAC proposals for 15.6ma

Purpose: Material for discussion in P802.15.6ma TG

Notice: This document has been prepared to assist the IEEE P802.15. It is offered as a basis for discussion and is not binding on the contributing individual(s) or organization(s). The material in this document is subject to change in form and content after further study. The contributor(s) reserve(s) the right to add, amend or withdraw material contained herein.

Release: The contributor acknowledges and accepts that this contribution becomes the property of IEEE and may be made publicly available by P802.15.

MAC Protocol Proposal for Multiple BAN Environment (Class 1),
Proposal of control and data channels unification for 6ma MAC
15-22-0639, #15-23-0387

Doc.#802.15-23-0408-01-06a (July 2023)

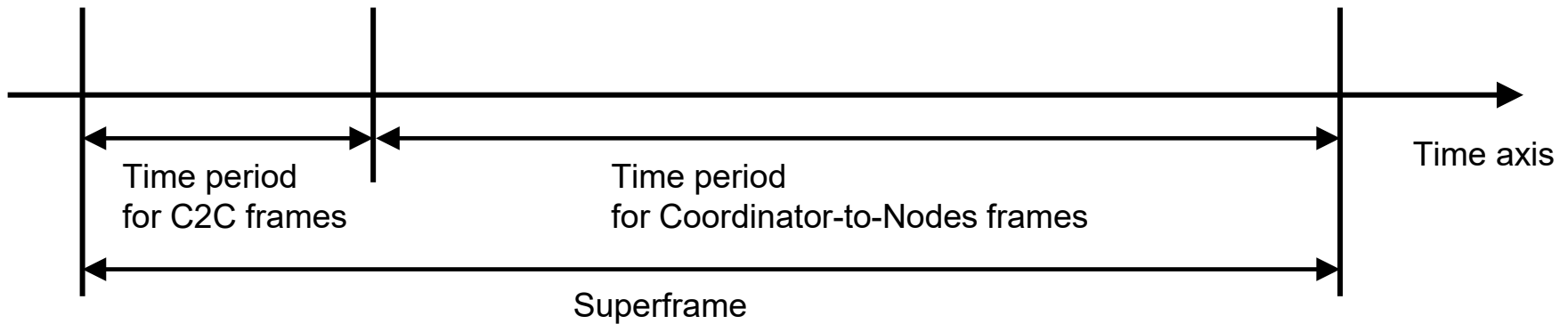

1. Unifying control and data channels into a single channel, instead of utilizing Control Channel, is proposed.
2. Frames for Coordinator to Coordinator link, previously carried by control channel, is carried by newly defined time period in the single channel.
3. For networks require higher dependability, feature of simultaneously utilizing multiple channel may still remain as optional.

Proposed text for 6ma MAC – General framework elements, Beacon Access Phase, Frames and IEs for dependable BAN, and Interference Avoidance

15-23-0322, # 15-23-0367, # 15-23-0369, # 15-23-0324

New terms are defined.

beacon access phase (BAP), coordinator hub, dependable BAN, dependable BAN group, leaf hub.

General explanation are modified according to new scope/features.

The revised standard will specify access coordination at the MAC sublayer between BANs.

Classes (1-3) of dependable BANs are defined.

In terms of bounded latency, probability of loss, update rate.

Length of superframe should be multiple times of fixed Basic Superframe Length.

Beacon Access Phase (BAP) is introduced.

A coordinator hub (a.k.a. super-coordinator or coordinator of coordinators) manage beacon slot allocation for leaf hubs. The last slot of BAP is reserved for a BAN of the original std.

New features such as Access offset, Access Phase shifting are introduced.

For mitigating the interference among coexisting dependable BANs, the start of access phase can be set differently.

Information Elements (IE) are added/defined according to the new features.

Convergence

Proposal # 15-22-0639 is going to be modified. the MAC will be able to use single channel too.

The fundamental difference of # 15-22-0639 and # 15-23-0322 series is already converged.

The detailed differences need to be examined more deeply, but the convergence of such differences will be much easier.

The differences in terminology will be also converged.

The two proposals have become very similar, but there are still many differences in terminology.

The convergence process will continue via teleconference prior to the September interim session, in order to complete the draft within the timeline.

8.5 MAC Function of Synchronization and access control in CCA and Inter-Coordinator Negotiation in Class 1, 2 and 4

- In CCA period, if a beacon is detected and a beacon packet preamble is decoded using pre-knowledge of possible coexisting systems, then it is possible to identify class of coexistence by detecting type and number of coexisting systems with MAC address, ID etc.

Reference: [cognitive sensing](#), [cognitive radio](#)

- If coordinators or hubs of coexisting BANs in class 1, 2 and 4 may communicate each other after identify coexisting systems, **the coordinators or hubs can negotiate each other to synchronize system clocks and to manage packets access** of individual 15.6ma and 15.6 BANs in class 1 and 2, respectively and 15.4ab WSNs/PANs in class 4.
- Even in class 3, 5, 6, and 7, **if interference from coexisting systems different from 15.6ma, 15.6, and 15.4ab can be mitigated**, then the same MAC function can be proceeded by the same manner as in class 1,2 and 4.

Project: IEEE P802.15 Working Group for Wireless Personal Area Networks (WPANs)

Submission Title: [MAC Protocol Using Negotiation among Coordinators in Coexistence of Multiple Wireless BANs]

Date Submitted: [15 November 2022]

Source: [Shunya Ogawa¹, Minsoo Kim,² Ryuji Kohno^{1,2}] [1;Yokohama National University, 2;YRP International Alliance Institute(YRP-IAI)]

Address [1; 79-5 Tokiwadai, Hodogaya-ku, Yokohama, Japan 240-8501

2; YRP1 Blg., 3-4 HikarinoOka, Yokosuka-City, Kanagawa, Japan 239-0847]

Voice:[1; +81-45-339-4115, 2:+358-8-553-2849], FAX: [+81-90-5408-0611],

Email:[1: ogawa-shunya-md@ynu.jp, kohno@ynu.ac.jp, 2: Kohno@yrp-iai.jpi]

Re: []

Abstract: [This is an updated version of doc.: IEEE 802.15-19-0402-00-0dep for a dependable MAC protocol for wireless body area network(WBAN) in presence of multiple overlaid BANS is introduced, A scheme of negotiation among coordinators could improve overall performance.]

Purpose: [information]

Notice: This document has been prepared to assist the IEEE P802.15. It is offered as a basis for discussion and is not binding on the contributing individual(s) or organization(s). The material in this document is subject to change in form and content after further study. The contributor(s) reserve(s) the right to add, amend or withdraw material contained herein.

Release: The contributor acknowledges and accepts that this contribution becomes the property of IEEE and may be made publicly available by P802.15.

- MAC Protocol Using Negotiation
among Coordinators in Coexistence of
Multiple Wireless BANs

Shunya Ogawa*, Minsoo Kim † , Ryuji Kohno* †

* Yokohama National University(YNU)

† YRP International Alliance Institute(YRP-IAI)

1. Introduction

1.1 Introduction

- From the development of an aging society and wireless communication technology, researches on medical information communication technology are thriving

➤ One solution is a WBAN (Wireless Body Area Network) IEEE802.15.6

WBAN

A network consisting of sensor nodes and coordinators installed around the human body

International standard of WBAN
Defined for physical layer and MAC layer

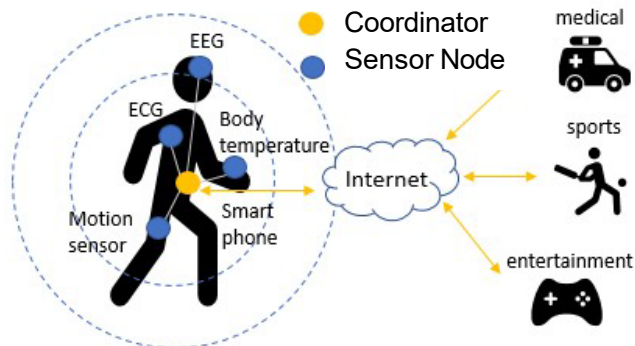

Fig1. Overall picture of WBAN network

This study changes the MAC layer



Hardware already sold
MAC layer can be changed by software

WBAN can control priority according to importance of data packet

- ◆ **In this research, we focus on the MAC layer of IEEE 802.15.6 and propose a MAC protocol that reduces inter-BAN interference**

1.2 Issues in the standard

Issue

- Interference problem in the case where multiple BANs overlap (specifically, situations where people with BAN approaching)
- Because the schedule adjustment between the coordinators has not been done



Proposal

- Negotiation between coordinators, scheduling between different BANs, to prevent deterioration due to inter-BAN interference

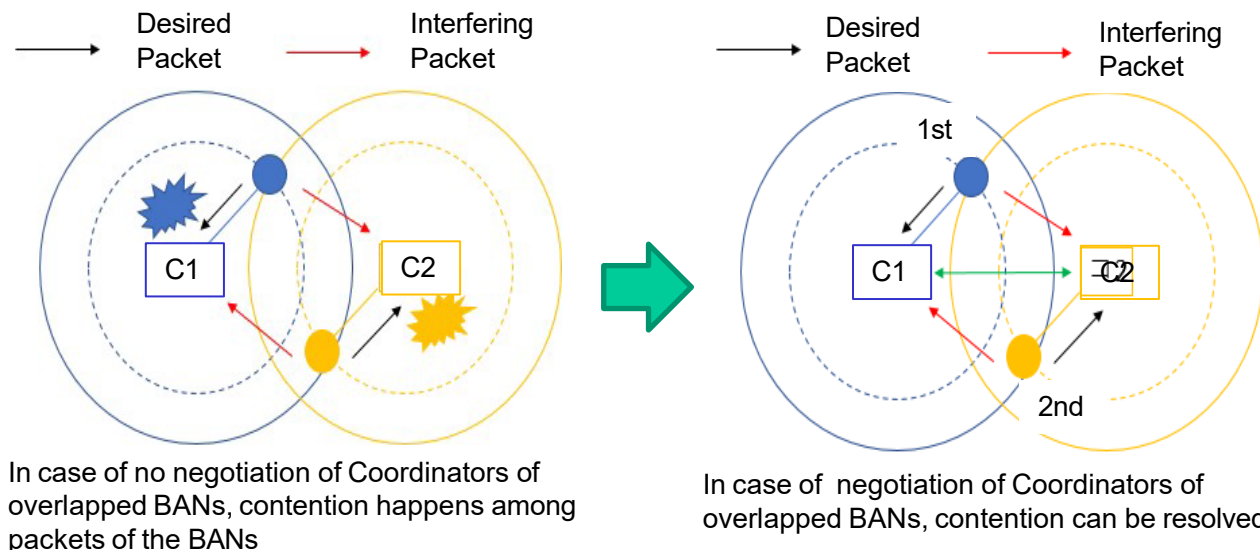

- What is interference at the MAC layer
- Sensor nodes within the communication range try to transmit packets at the same timing, causing collisions, making it impossible to communicate correctly

Fig2. Issue and proposal

2. Proposed method

Purpose

2.1 Outline of proposed method

- Increase the throughput of each BAN in case of interference
- Communication should be guaranteed in descending order of User Priority

Proposal

- Negotiate between coordinators, share the overlap situation of the sensor nodes, and identify the sensor nodes that will cause contention
- Do not send them at the same time

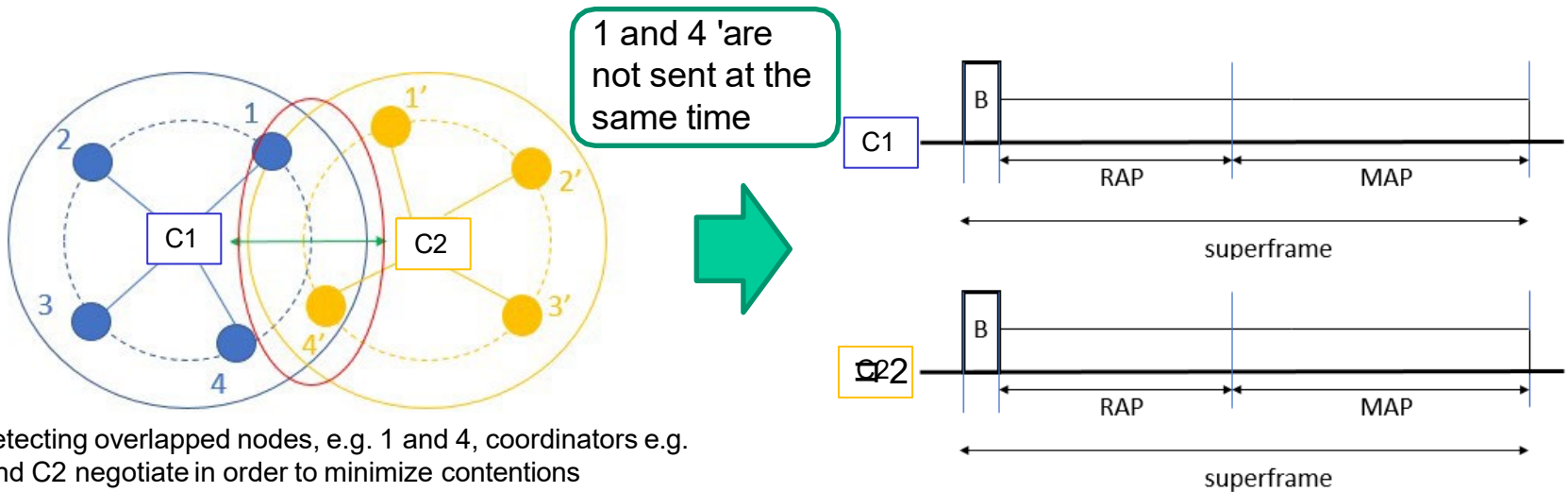

Fig3. Outline of proposed method

2.2 Time synchronization method between coordinators

1. The time difference between receiving the beacon frames of the two coordinators is used as the offset value.

$$TT_{\text{offset}} = TT_1 - TT_0 \cdots (1)$$

TT_1 :Overlap coordinator beacon time TT_0 :Reference coordinator beacon time

2. Calculate the amount of time adjustment ($TT_{\text{adjustment}}$) based on the offset value

$$TT_{\text{adjustment}} = TT_{\text{offset}_1} - TT_{\text{offset}_0} \cdots (2)$$

TT_{offset_1} :Offset value obtained from the reception of previous beacon frame

TT_{offset_0} :Offset value obtained from the reception of the current beacon frame

If the value of $TT_{\text{adjustment}}$ is greater than 0, stop the time of the reference coordinator by the value of $TT_{\text{adjustment}}$ and vice versa

2.3 procedure of how to identify overlap situations

1. Since BAN uses UWB communication, it uses physical layer information that indicates the distance (between coordinators and sensor nodes)

➤ By knowing the distance between a sensor node and the coordinator, it is possible to identify whether or not the node is within its communication range

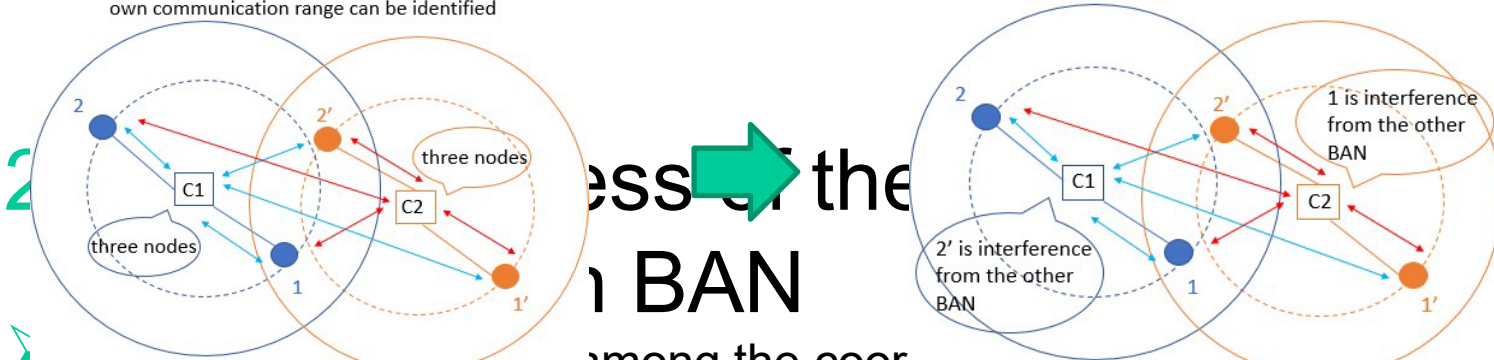

➤ By sharing the address among the coordinators, it is possible to identify whether a sensor node within the trust range is under its own control or under the control of another BAN

2.4 MAC protocol of MAP(Managed access period)

Proposal

(Adopt polling for MAP)

- Divide Superframe's MAP structure into two parts, MAP 1 and MAP 2
- 1. In MAP 1, sensor nodes **not related to interference** are allocated
 - Send at the same time
- 2. In MAP 2, sensor nodes **related to interference** are allocated
 - When one BAN attempts to transmit at MAP 2, the other BAN is placed in a standby state

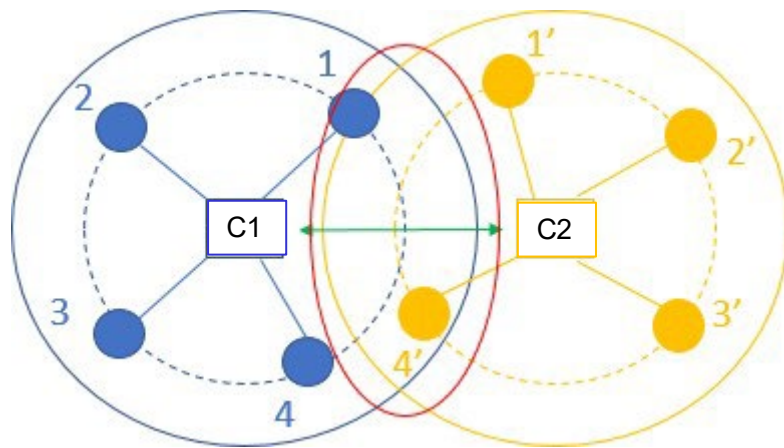

		MAP1			MAP2		
		Non Overlapped Nodes			Overlapped Nodes		
C1	B	4	2	3	1	×	1
		○	○	○	○		○
C2	B						
		○	○	○	○		
	B	1'	3'	2'	×	4'	×

○は送信成功, ×は待機状態

Fig4. MAC protocol of MAP

◆ By separating by interference and non-interference, packet collision does not occur and efficient transmission can be done

2.5 MAC protocol of RAP(Random Access Period)

Proposal (Adopt CSMA / CA for RAP)

- The Superframe's RAP protocol is as follows
- 1. If the interfering node is low UP (4 or less), do not conflict transmission rights (those with lower UP than competing nodes do not compete)**
 - 2. If the interference node is high UP (5 or more), compete transmission rights of normal CSMA/CA**

Although contention will occur, it will guarantee in descending order of UP

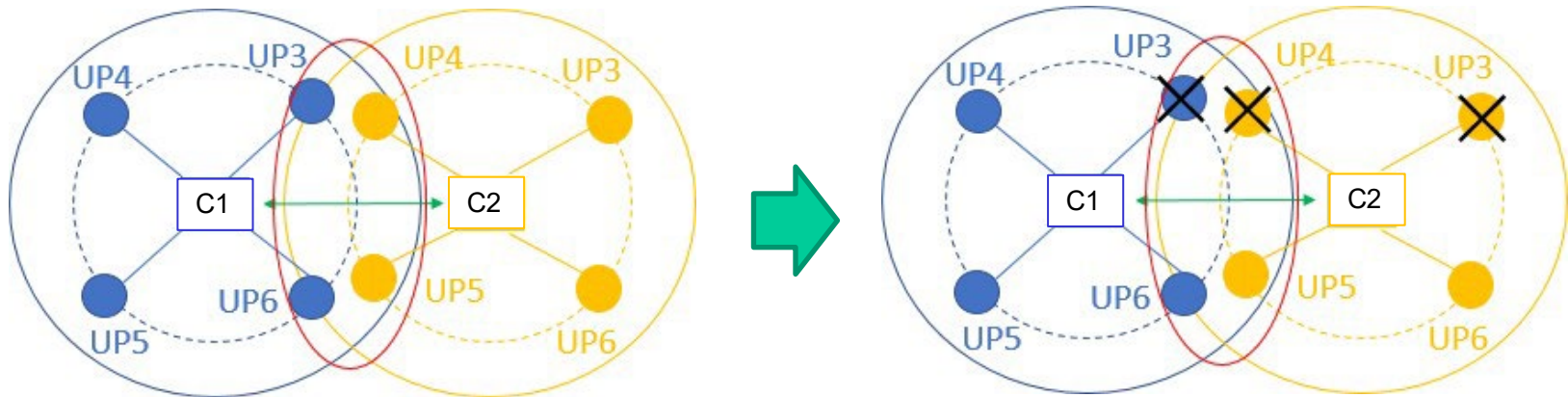

Fig5. MAC protocol of RAP

- It is possible to reduce the contention of packets while guaranteeing in descending order of UP**

2.6 Drawback of proposed method

1. MAC protocol of MAP
 - Depending on the number of interfering nodes, the characteristics are degraded
 - The number of slots of MAP 1 and MAP 2 of Superframe becomes **extra**

2. MAC protocol of RAP
 - When **offeredload is low**, the delay characteristic deteriorates
 - When packet occurrence interval is large, deterioration due to not competing transmission right is large

- ◆ **Even if these two combinations are used, only the average UP as a whole improves, high UP is particularly guaranteed, and low UP is sacrificed can not be controlled for each purpose**

- ◆ **We aim to respond by changing parameters according to design policy**

3. Measures against drawback

3.1 Measures to drawback MAP

Measures

- Change the ratio of the number of slots of MAP 1 and MAP 2 of Superframe
- **MAP 1 : MAP 2 = number of non-interfering nodes ÷ 2 : to be the number of interference nodes**

(It is known from the simulation that this is the optimal solution)

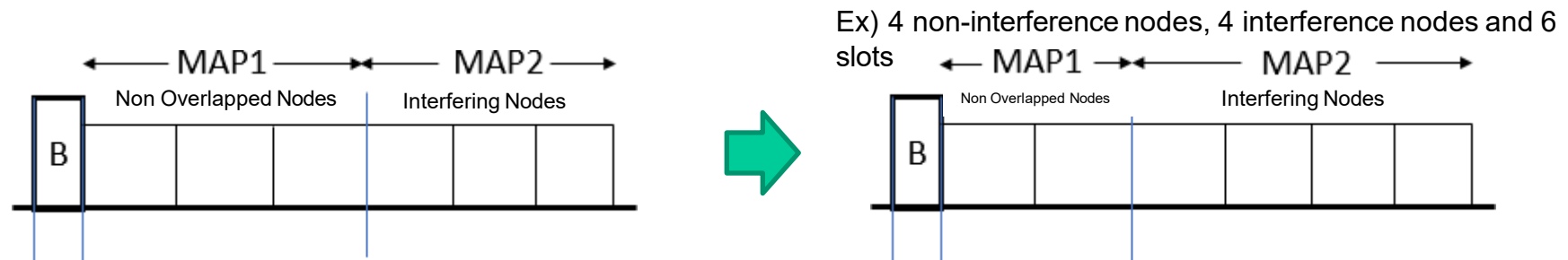

Fig6. Measures to drawback MAP

- ◆ **By changing the ratio of the number of slots of MAP 1 and MAP 2 according to the number of interfering nodes, there is no extra**

3.2 Measures to drawback MAP

Measures

- **Switch on whether to use the proposed method for each offeredload**
 - When offeredload is low, competing transmission rights of normal CSMA / CA
 - When the offer load becomes such that packets conflict, countermeasures against interference are made using the proposed method

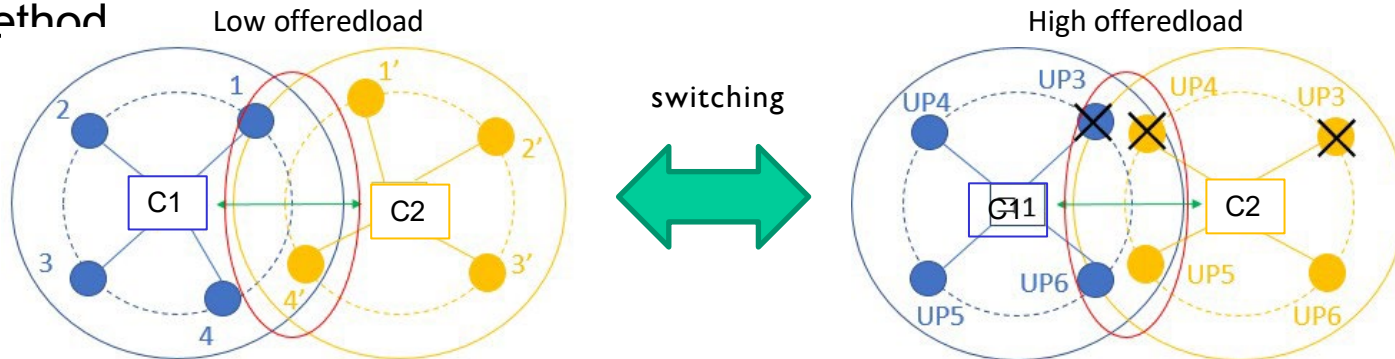

Fig7. Measures to drawback MAP

- ◆ **Due to the switching of the proposed scheme, the deterioration at the time of low offeredload decreases**

3.3 Control to make the priority higher

- We propose a MAC protocol not only giving average performance as a whole, but also **differentiating between high UP and low UP**

RAP

- If it is low UP (4 or less) **irrespective of interference or non-interference**, do not compete transmission right
- If it is high UP (5 or more) **irrespective of interference or non-interference**, compete transmission right

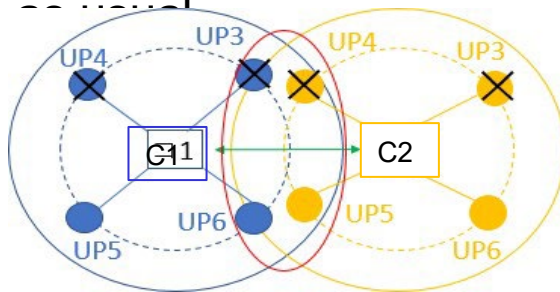

Fig8. RAP

MAP

How to assign transmission rights

The one with the largest
UP value × elapsed time



We changed the weighting
value called UP value

Weighting to make the priority more
dominant

- By changing parameters, we can cope with each design policy (giving average performance , differentiating between high UP and low UP)**

4. Performance evaluation by simulation

4.1 Simulation characteristics

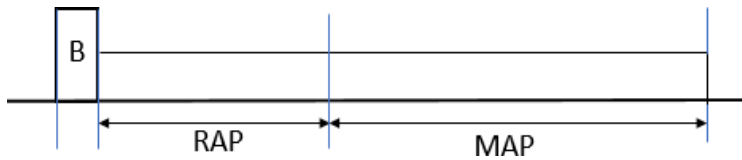

Fig9. Superframe structure

There is no EAP for simplicity

- Determining parameters based on the standard (IEEE 802.15.6)
- The probability of occurrence for each UP is the same
- One type of packet is generated from one node
- RAP, MAP handle all packets
- The condition for discarding the packet is the case where the number of retransmissions is 4 or more and the case where the number of packets to be crowded becomes 3 or more

Table1. simulation characteristics

Number of nodes	4(UP高2,低2)
Data rate	242.9 [kbps]
Payload length	128 [octets]
Number of BANs	2
Superframe length	115 [ms]
Number of slots	RAP=5,MAP=12
Simulation time	30 [s]
Number of trials	100

Content of evaluation

- Overall network throughput characteristics
- Throughput characteristics per UP
- Delay characteristics per UP

Evaluation is made in two ways such as average performance, differentiating between high UP and low UP

4.2 Simulation scenario

1, there are no interference node each

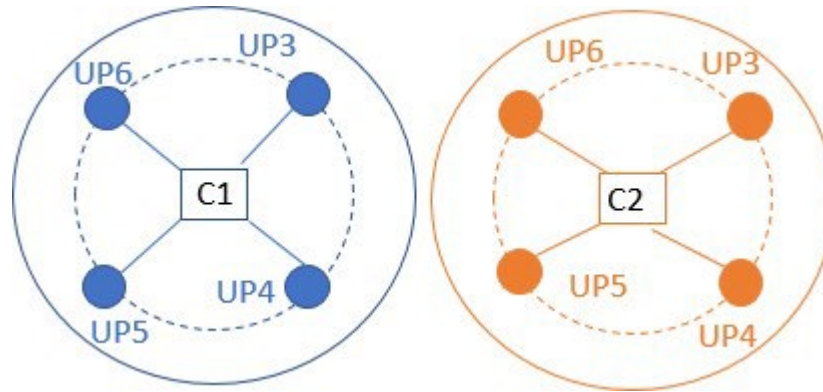

2, there are two interference nodes each

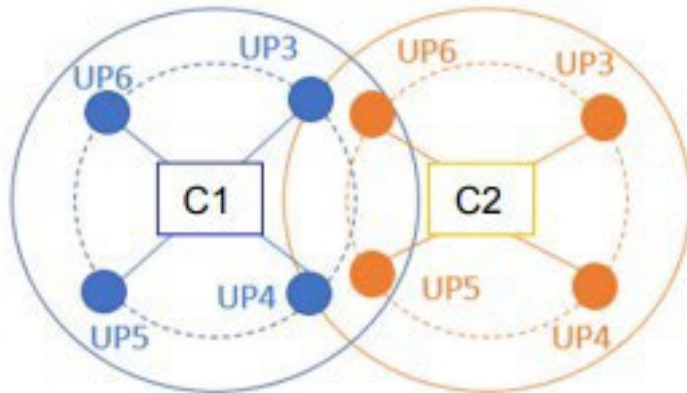

3, there are four(all) interference nodes each

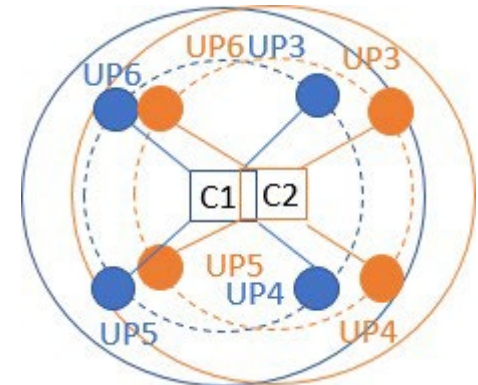

4.3 Simulation result(Total throughput)

Average performance

Differentiating between low UP and high UP

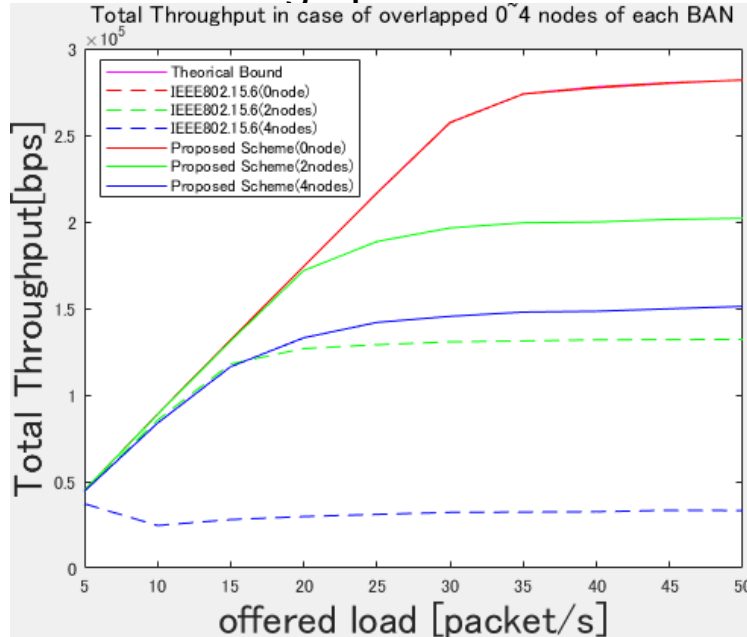

Fig11. Overall network throughput

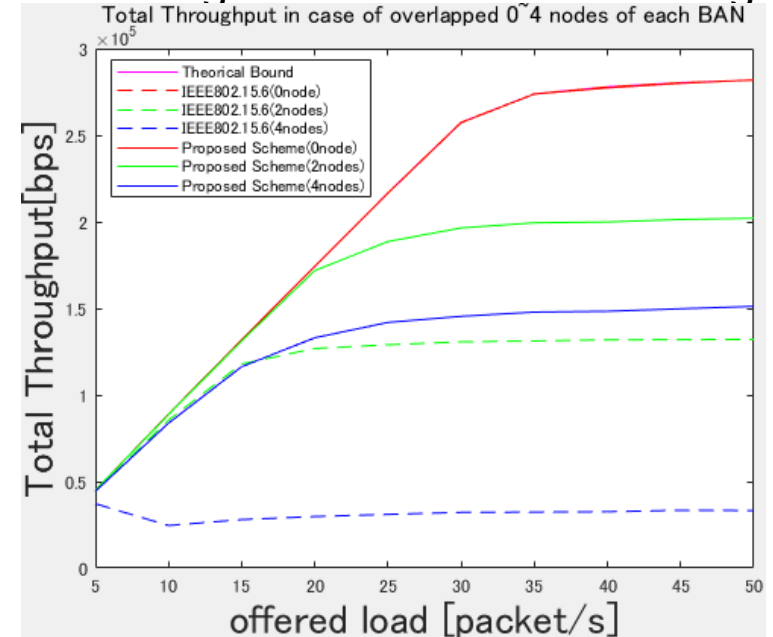

Fig12. Overall network throughput

- **The theoretical bound is the throughput of the entire network in the absence of interference**
- Compared to the standard, the throughput of the whole network is improved in the proposed method in each case
- Since there is no difference in overall throughput by design policy, both are valid

4.3 Simulation result(Throughput of each UP overlapped 2 nodes)

Average performance

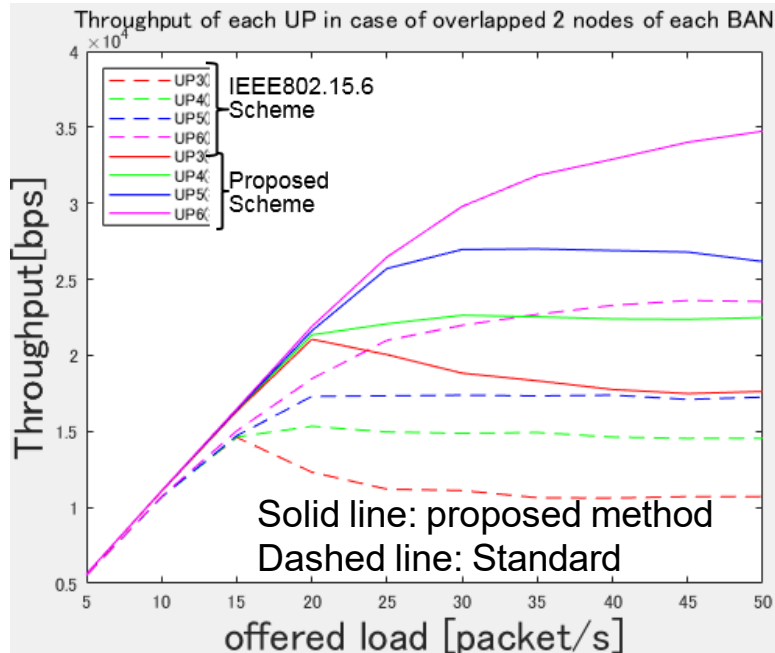

Fig13. Throughput of each UP overlapped 2 nodes

Differentiating between low UP and high UP

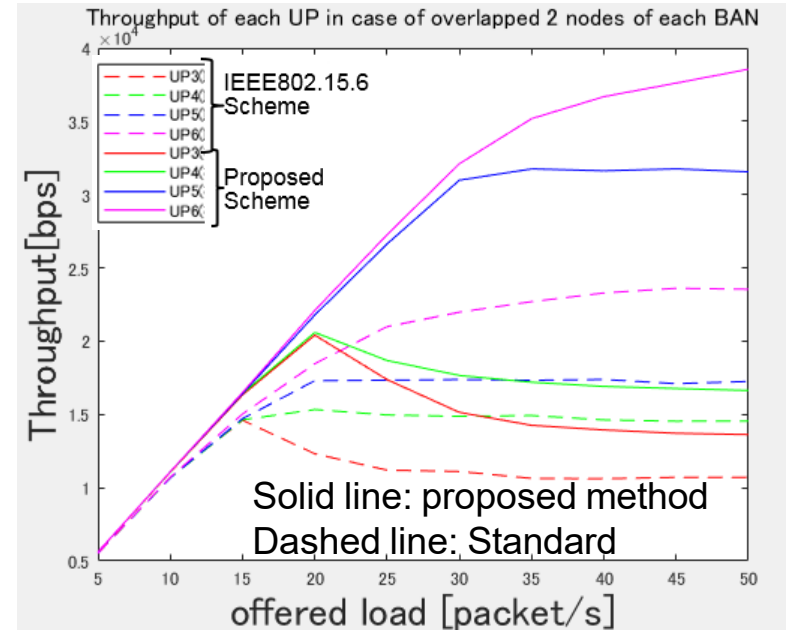

Fig14. Throughput of each UP overlapped 2 nodes

- Similarly, the proposed method is superior to the throughput for each UP
- We can cope with the case where average performance is given and the case where difference is given for each UP

4.3 Simulation result(Throughput of each UP overlapped 0,4 nodes)

Average performance

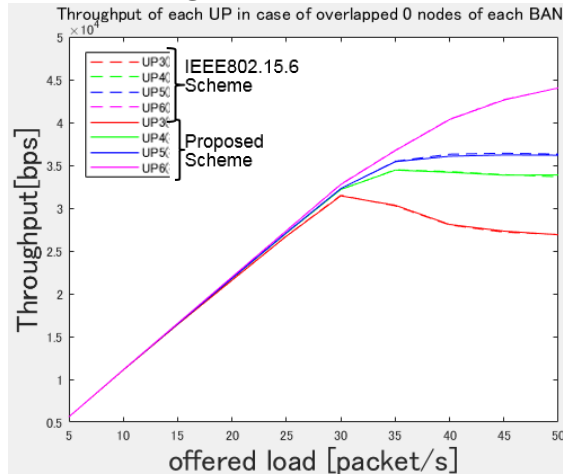

Fig15. Throughput of each UP overlapped 0 node

Differentiating between low UP and high UP

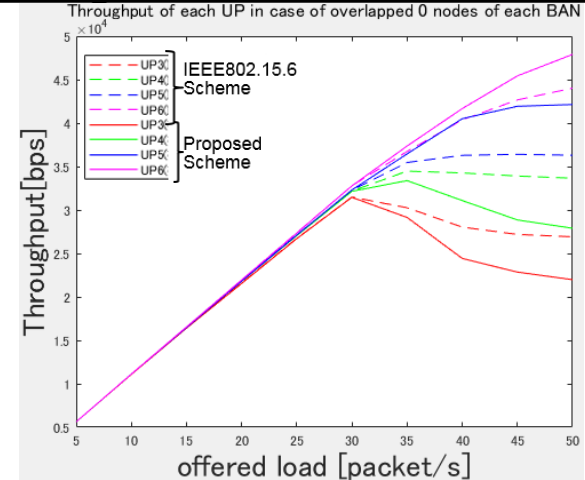

Fig16. Throughput of each UP overlapped 0 node

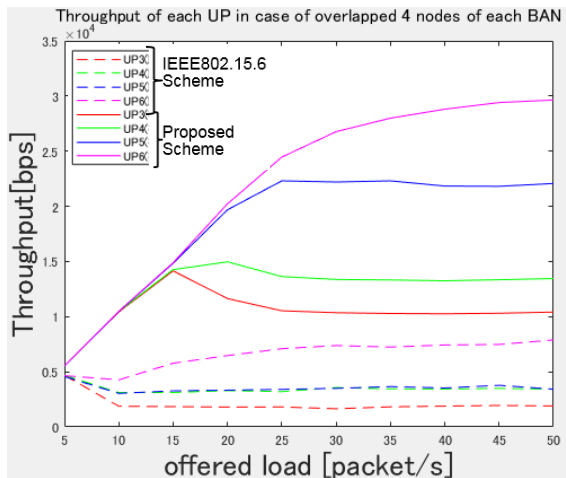

Fig17. Throughput of each UP overlapped 4 nodes

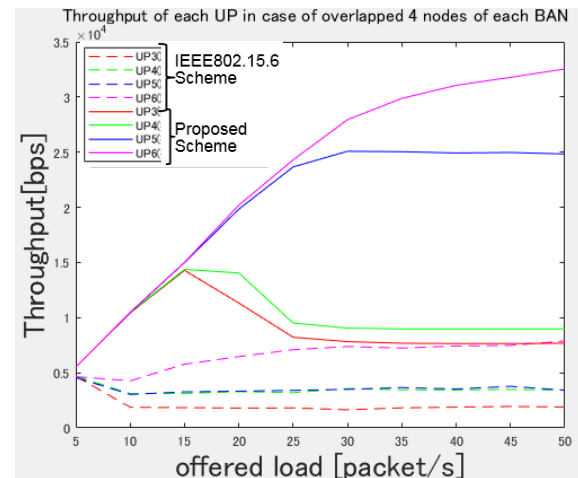

Fig18. Throughput of each UP overlapped 4 nodes

4.3 Simulation result(Delay of each UP overlapped 2 nodes)

Average performance

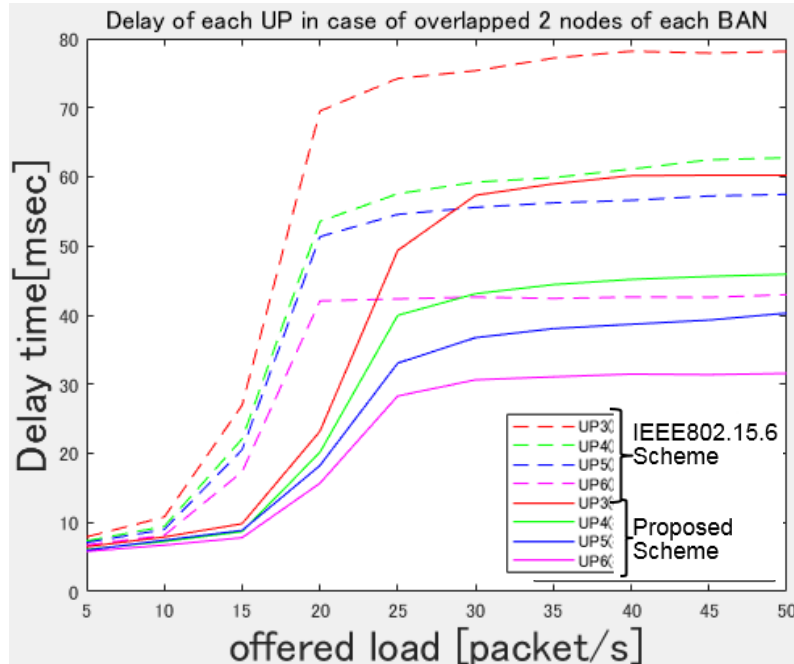

Fig19. Delay of each UP overlapped 2 nodes

Differentiating between low UP and high UP

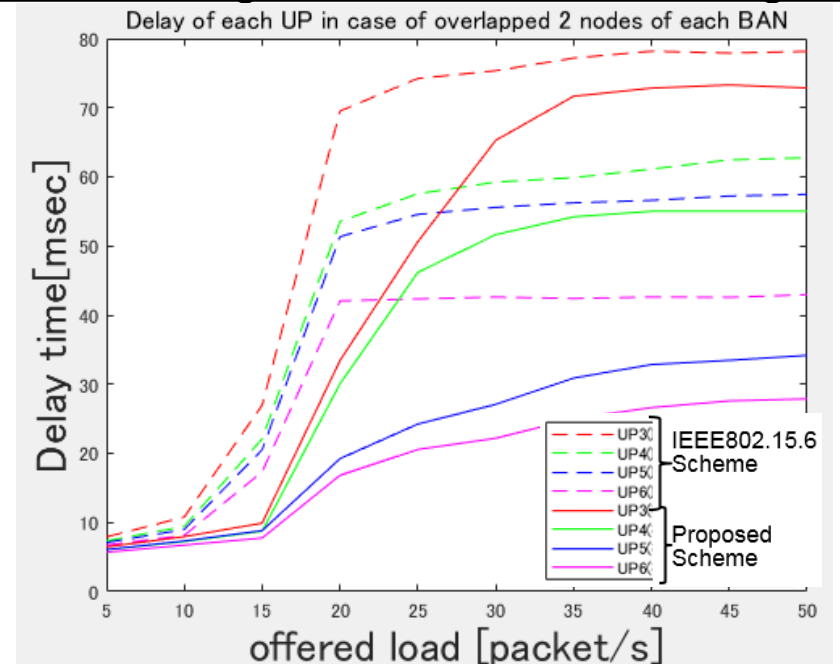

Fig20. Delay of each UP overlapped 2 nodes

- Similarly, the proposed method is superior to the throughput for each UP
- We can cope with the case where average performance is given and the case where difference is given for each UP

4.3 Simulation result(Throughput of each UP overlapped 0,4 nodes)

Average performance

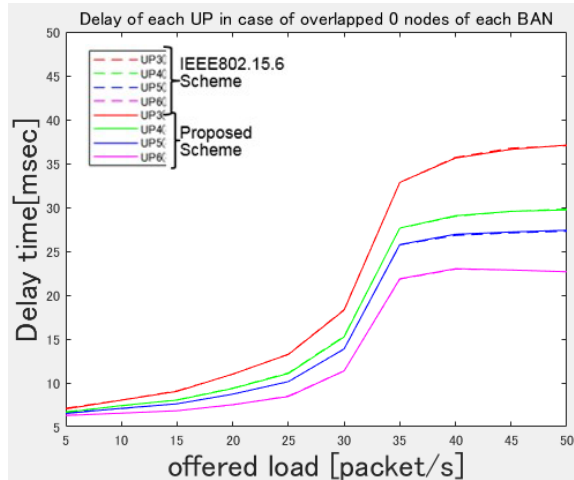

Fig21. Delay of each UP overlapped 0 node

Differentiating between low UP and high UP

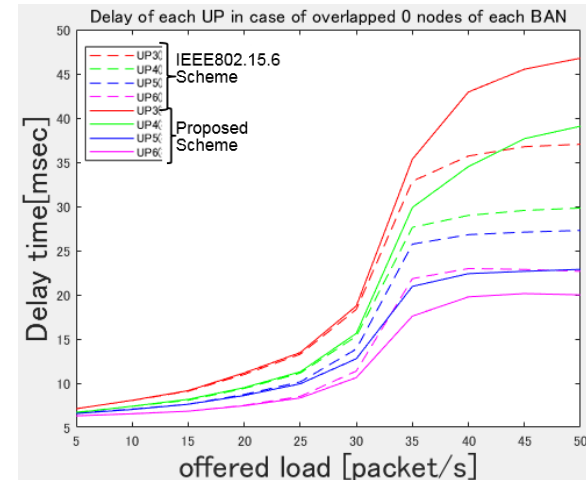

Fig22. Delay of each UP overlapped 0 node

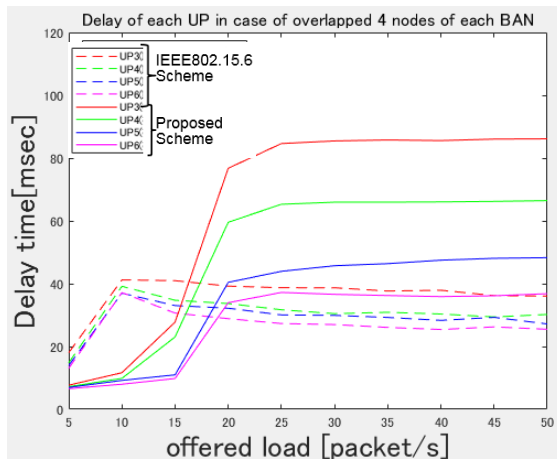

Fig23. Delay of each UP overlapped 4 nodes

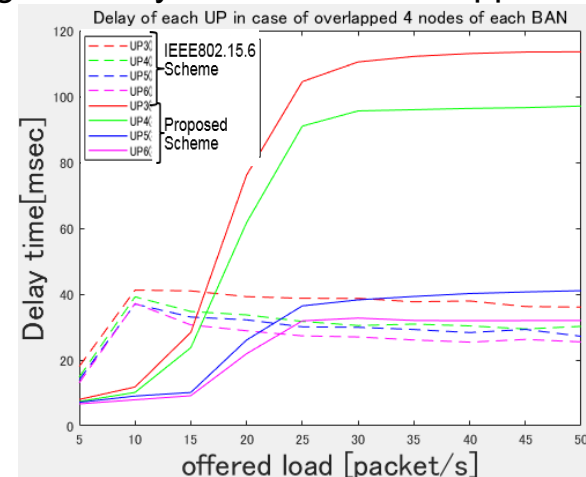

Fig24. Delay of each UP overlapped 4 nodes

5. Conclusion

5.1 Conclusion and Future works

Conclusion

- We conducted research to mitigate interference against the international standard MAC protocol
- In order to reduce interference in multiple BAN environments, we propose to communicate between coordinators to identify and share interfering nodes, and the proposed protocol has improved throughput and delay characteristics over international standards
- We showed that we can deal with by changing parameters according to design policy

Future works

- Consideration when the number of BAN becomes **3 or more**
- Consideration when **packet occurrence probability changes** for each UP
- Theoretical analysis on **optimum values** of various parameters
- MAP 1 and MAP 2 ratio, UP weighting etc.

8.6 MAC for Transition among Different Classes of Coexistence

- In practical use cases, if mobility of BAN should be taken into account, then MAC function for transition among different classes of coexistence should be defined.
- While periodical detection in CCA period, if a beacon is detected and a beacon packet preamble is decoded using pre-knowledge of possible coexisting systems, then it is possible to identify transition of classes of coexistence.
- The transition of classes of coexistence can be described with finite state transition diagram such as Markov model.
- In practical use cases, the finite state or class transition can be simplified and useful to predict transition using probabilistic approach.
- The transition between class 0 and 1 could be covered by above-mentioned MAC. The transition among classes 0, 1, 2 and 4 may be described shortly only in case that legacy 15.6-2012 BAN and 15.4ab can be detectable by new 15,6ma BAN.
- Transition to class 3, 5, 6, and 7 can be detectable in periodical CCA, so interference from coexisting systems different from 15.6ma, 15.6, and 15.4ab can be mitigated and then the same MAC could be proceeded by the same manner as in class 1,2 and 4.

Reference

Documents of Minsoo Kim, Seong-Soon Joo, Marco Hernandez, and others