

Project: IEEE P802.15 Working Group for Wireless Personal Area Networks (WPANs)

Submission Title: Adaptive MIMO OFDM PHY Proposal for IEEE 802.15.7r1

Date Submitted: January 10, 2016

Source: Murat Uysal (Ozyegin University), Omer Narmanlioglu (Ozyegin University), Tuncer Baykas (Istanbul Medipol University), Refik Kizilirmak (Nazarbayev University)

Address: Ozyegin University, Nisanteppe Mh. Orman Sk. No:34-36 Çekmekoy 34794 Istanbul, Turkey
Voice: +90 (216) 5649329, Fax: +90 (216) 5649450, E-Mail: murat.uysal@ozyegin.edu.tr

Abstract: This contribution presents a partial PHY proposal for IEEE 802.15.7r1 based on adaptive MIMO OFDM architecture.

Purpose: This is a partial PHY proposal based on adaptive MIMO OFDM architecture. Such advanced features are essential to achieve the ambitious targets of 10 Gbit/s envisioned in TCD Document.

Notice: This document has been prepared to assist the IEEE P802.15. It is offered as a basis for discussion and is not binding on the contributing individual(s) or organization(s). The material in this document is subject to change in form and content after further study. The contributor(s) reserve(s) the right to add, amend or withdraw material contained herein.

Release: The contributor acknowledges and accepts that this contribution becomes the property of IEEE and may be made publicly available by P802.15.

Adaptive MIMO OFDM VLC PHY Proposal for IEEE802.15.7r1

Outline

- Introduction
- Description of adaptive MIMO OFDM VLC System
- Simulation Settings and Results
- Conclusions

Introduction

- This contribution presents a partial PHY proposal based on **adaptive MIMO OFDM** architecture. Such advanced features are essential to achieve the ambitious targets of 10 Gbit/s envisioned in IEEE 802.15.7r1 TCD Document

Related excerpts from the TCD Document

4.5.3

The standard must support at least one PHY mode that supports peak data rates of 10 Gbps at the PHY SAP.

4.5.5

The standard must provide MAC/PHY mechanisms to support adaptive transmission as well as the support of multiple users communicating different data streams from the same light source (multiple access).

4.5.9

The standard must support at least one optional PHY mode that supports multiple coordinated/uncoordinated transmitters, which is referred to as multiple-input multiple-output (MIMO) communications.

Background (1): MIMO Communications

- MIMO schemes can provide either improvement in spectral efficiency (through multiplexing gain) or link reliability (through diversity gain).
- **Spatial Multiplexing (SMUX)**
 - Independent data streams are sent through each transmit element.
 - Multiplexing gain is $\min(N_T, N_R)$ where N_T and N_R respectively denote the transmit and receive elements.
- **Space-Time Coding (STC)**
 - Coded data streams are sent through each transmit element.
 - STC provides SNR gains.
 - Unlike RF communications with coherent detection, VLC systems can use simple versions of space-time coding (**repetition coding, RC**)^{1,2}.

¹ T. Fath and H. Haas, "Performance Comparison of MIMO Techniques for Optical Wireless Communications in Indoor Environments," *IEEE Transactions on Communications*, vol.61, no.2, pp.733-742, February 2013.

² M. Safari and M. Uysal, "Do We Really Need OSTBCs for Free-Space Optical Communication with Direct Detection?," *IEEE Transactions on Wireless Communications*, vol. 7, no. 11, p. 4445-4448, November 2008.

Background (2): Link Adaptation

- In adaptive communication systems, transmission parameters such as modulation type/size, transmit power etc. can be selected according to channel conditions.
- **Example:** In low SNR conditions, to ensure link reliability, a modulation with small constellation size (e.g., BPSK) can be used. In high SNR conditions, high order modulation (e.g., 8-PSK) can be used to increase the data link.
- In MIMO systems, spatial dimension can be further included as an additional adaptive parameter, i.e., MIMO type, configuration etc.
- Link adaptation is commonly deployed in RF wireless standards, i.e., cellular, WiFi etc.

Background (3): O-OFDM

- As observed from reference channel models, the VLC channel is of multipath nature and results in frequency-selectivity when high data speeds are targeted. An efficient approach to mitigate intersymbol interference (ISI) resulting from high frequency-selectivity is orthogonal frequency division multiplexing (OFDM).
- OFDM is a multi-carrier transmission system where the high-rate data stream is demultiplexed and transmitted over a number of frequency subcarriers. In general, OFDM output is complex and bipolar; however, a real and non-negative signal should be used in optical communication with intensity modulation.
- To solve this problem, modified OFDM schemes are proposed in the literature
 - DC biased optical OFDM (DCO-OFDM) ³
 - Asymmetrically clipped optical OFDM (ACO-OFDM) ⁴
 - Unipolar OFDM ⁵ or Flip OFDM ⁶

³ J. Armstrong, "OFDM for optical communications," *Journal of Lightwave Technology*, vol. 27, no. 3, pp. 189–204, February 2009.

⁴ J. Armstrong and A. Lowery, "Power efficient optical OFDM," *Electronics Letters*, vol. 42, no. 6, pp. 370–372, March 2006.

⁵ N. Fernando, Y. Hong, and E. Viterbo, "Flip-OFDM for unipolar communication systems," *IEEE Transactions on Communications*, vol. 60, no. 12, pp. 3726–3733, December 2012.

⁶ D. Tsonev, S. Sinanovic, and H. Haas, "Novel unipolar orthogonal frequency division multiplexing U-OFDM for optical wireless communication," *IEEE Vehicular Technology Conference*, 2012.

Block Diagram of Adaptive MIMO OFDM

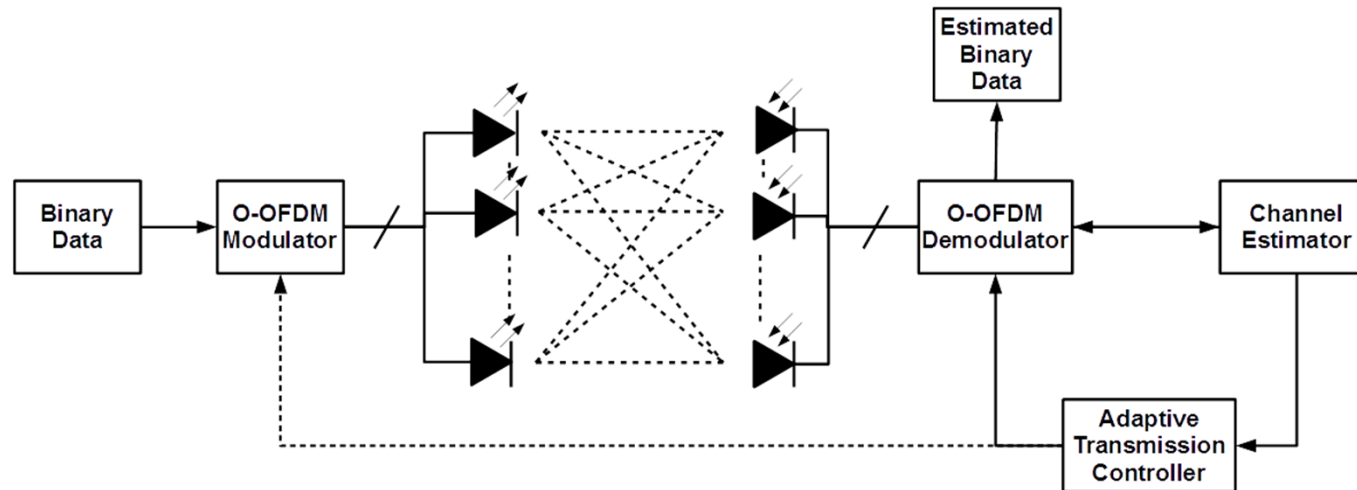

- Channel state information (CSI) is estimated. This includes the estimation of signal-to-noise-ratio, multipath channel coefficients, etc.
- According to the CSI, adaptive transmission controller at the receiver selects the optimal transmission parameters (i.e., modulation type, modulation order, MIMO configuration and MIMO type) that yield the highest performance metric under a given constraint metric and feeds back to the transmitter.
- To further improve the system performance, bit loading can be further performed.

Look-Up Table (LUT)

Transmission Mode (TM)	MIMO Configuration	MIMO Type	Modulation Type	Modulation Order	Performance Metric	Constraint Metric
1	1x1	RC	PSK	2	Pre-determined values for performance metric according to QoS requirements for targeted applications	Pre-determined values for constraint metric according to QoS requirements for targeted applications
2	1x2	SMUX	QAM	4		
.	...			8		
.	$N_T \times N_R$			16		
.				32		
				64		
				128		
				256		
				512		
				1024		
				2048		
				4096		

Each transmission mode (TM) is a unique combination of

- MIMO configuration
- MIMO type
- Modulation type
- Modulation order

OFDM Modulator/Demodulator

- The proposed adaptive structure is independent of OFDM type. In our proposal, we use DCO-OFDM with its better spectral efficiency in comparison to ACO-OFDM.

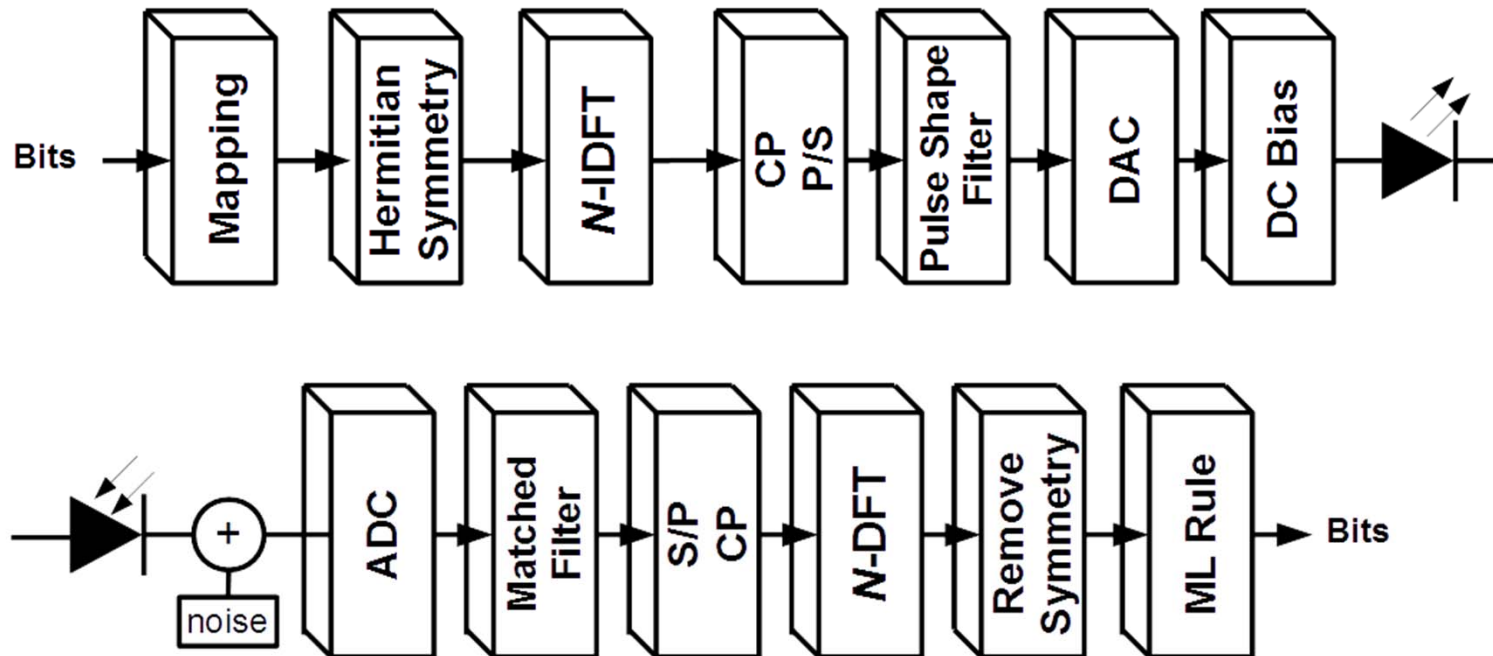

MIMO Schemes

- In our proposal, we use **repetition code** or **spatial multiplexing** to provide diversity or multiplexing gain.
- **Repetition coding (RC)**

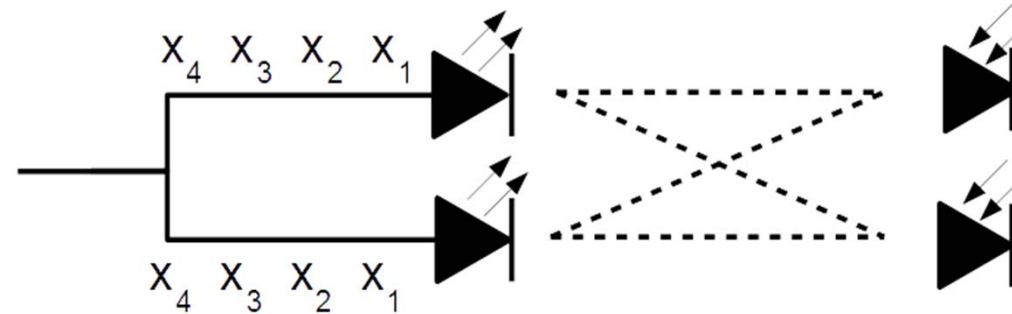

- **Spatial Multiplexing (SMUX)**

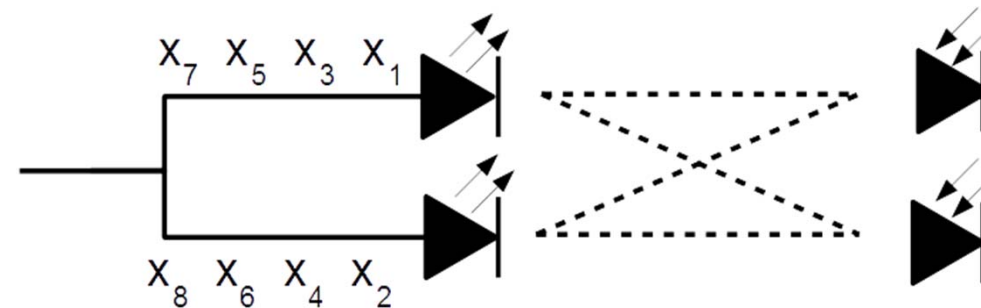

Calculation of Data Rate

○ **RC**
$$R = \frac{1}{T_S} \frac{L_D}{L_{SC} + L_{CP}} \log_2 M$$

○ **SMUX**
$$R = \frac{1}{T_S} \frac{L_D}{L_{SC} + L_{CP}} \min(N_T, N_R) \log_2 M$$

R : PHY data rate

L_{SC} : Number of subcarriers

L_D : Number of data subcarriers

L_{CP} : Length of cyclic prefix

N_T : Number of LEDs used in transmission

N_R : Number of photodetectors used in transmission

M : Modulation order

B : Signal bandwidth

T_S : Sampling interval in second (= $2B$ at Nyquist Rate)

PHY Data Rates

System Parameters

B	20 MHz
L_{SC}	256
L_D	96
L_{CP}	12

Diversity Mode

PHY data rates (Mbit/s)					
Modulation	1x1	2x2	4x4	6x6	8x8
BPSK	14,33	14,33	14,33	14,33	14,33
4-QAM	28,66	28,66	28,66	28,66	28,66
8-QAM	42,99	42,99	42,99	42,99	42,99
16-QAM	57,31	57,31	57,31	57,31	57,31
32-QAM	71,64	71,64	71,64	71,64	71,64
64-QAM	85,97	85,97	85,97	85,97	85,97
128-QAM	100,30	100,30	100,30	100,30	100,30
256-QAM	114,63	114,63	114,63	114,63	114,63
512-QAM	128,96	128,96	128,96	128,96	128,96
1024-QAM	143,28	143,28	143,28	143,28	143,28
2048-QAM	157,61	157,61	157,61	157,61	157,61
4096-QAM	171,94	171,94	171,94	171,94	171,94

Multiplexing Mode

PHY data rates (Mbit/s)					
Modulation	1x1	2x2	4x4	6x6	8x8
BPSK	14,33	28,66	57,31	85,97	114,63
4-QAM	28,66	57,31	114,63	171,94	229,25
8-QAM	42,99	85,97	171,94	257,91	343,88
16-QAM	57,31	114,63	229,25	343,88	458,51
32-QAM	71,64	143,28	286,57	429,85	573,13
64-QAM	85,97	171,94	343,88	515,82	687,76
128-QAM	100,30	200,60	401,19	601,79	802,39
256-QAM	114,63	229,25	458,51	687,76	917,01
512-QAM	128,96	257,91	515,82	773,73	1031,64
1024-QAM	143,28	286,57	573,13	859,70	1146,27
2048-QAM	157,61	315,22	630,45	945,67	1260,90
4096-QAM	171,94	343,88	687,76	1031,64	1375,52

PHY Data Rates

System Parameters

B	200 MHz
L_{SC}	2048
L_D	960
L_{CP}	96

Diversity Mode

PHY data rates (Gbit/s)					
Modulation	1x1	2x2	4x4	6x6	8x8
BPSK	0,18	0,18	0,18	0,18	0,18
4-QAM	0,36	0,36	0,36	0,36	0,36
8-QAM	0,54	0,54	0,54	0,54	0,54
16-QAM	0,72	0,72	0,72	0,72	0,72
32-QAM	0,90	0,90	0,90	0,90	0,90
64-QAM	1,07	1,07	1,07	1,07	1,07
128-QAM	1,25	1,25	1,25	1,25	1,25
256-QAM	1,43	1,43	1,43	1,43	1,43
512-QAM	1,61	1,61	1,61	1,61	1,61
1024-QAM	1,79	1,79	1,79	1,79	1,79
2048-QAM	1,97	1,97	1,97	1,97	1,97
4096-QAM	2,15	2,15	2,15	2,15	2,15

Multiplexing Mode

PHY data rates (Gbit/s)					
Modulation	1x1	2x2	4x4	6x6	8x8
BPSK	0,18	0,36	0,72	1,07	1,43
4-QAM	0,36	0,72	1,43	2,15	2,87
8-QAM	0,54	1,07	2,15	3,22	4,30
16-QAM	0,72	1,43	2,87	4,30	5,73
32-QAM	0,90	1,79	3,58	5,37	7,16
64-QAM	1,07	2,15	4,30	6,45	8,60
128-QAM	1,25	2,51	5,01	7,52	10,03
256-QAM	1,43	2,87	5,73	8,60	11,46
512-QAM	1,61	3,22	6,45	9,67	12,90
1024-QAM	1,79	3,58	7,16	10,75	14,33
2048-QAM	1,97	3,94	7,88	11,82	15,76
4096-QAM	2,15	4,30	8,60	12,90	17,19

Adaptive Transmission: Flow Chart

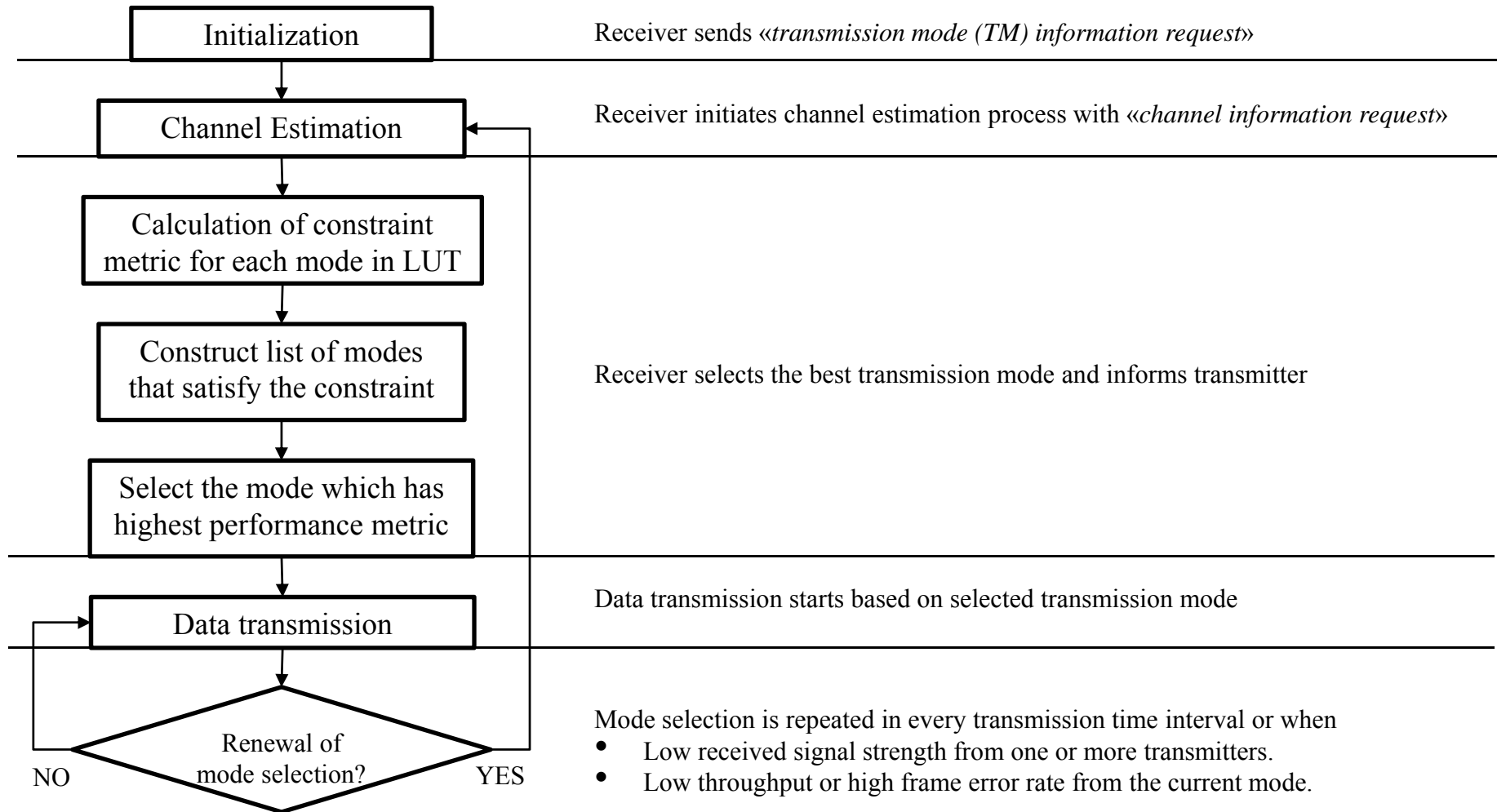

Adaptive Transmission: Setup Sequence

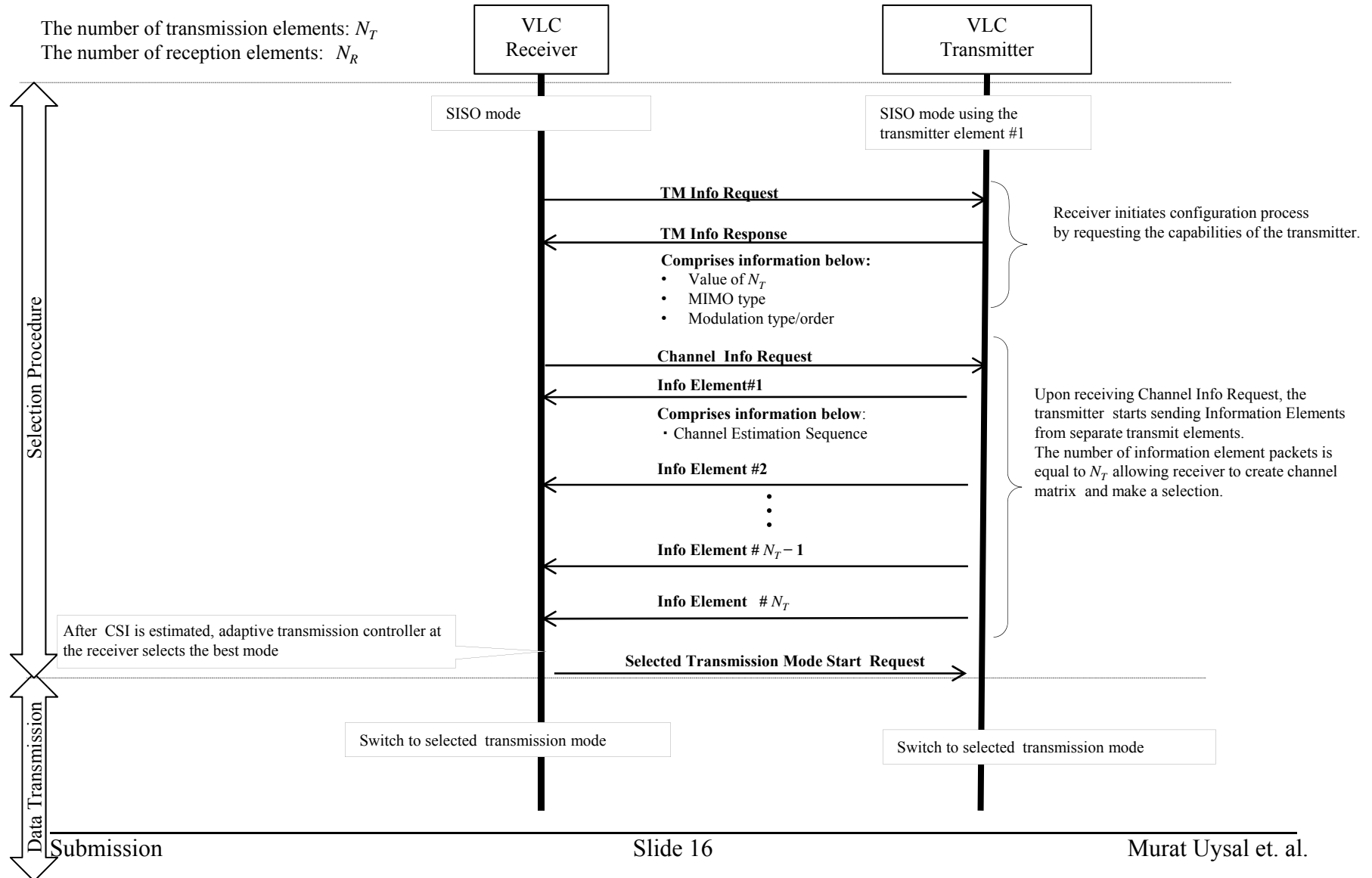

Adaptive Transmission: PHY Frame Structure

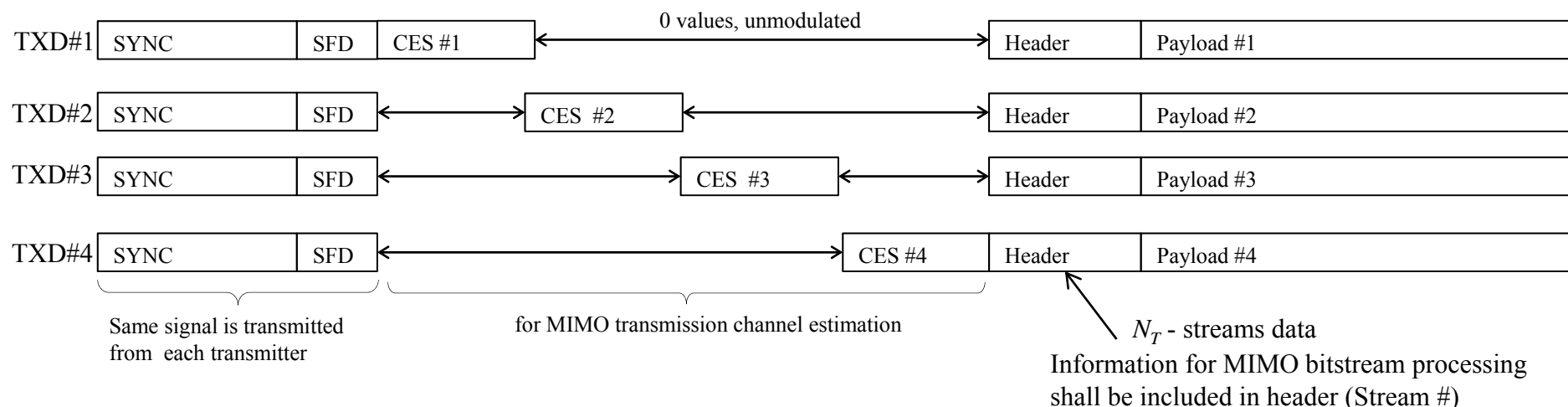

- Synchronization (SYNC) part is used for frame detection, frame synchronization, frequency recovery and timing acquisition. Start Frame Delimiter (SFD) is to show that SYNC part finished.
- Channel Estimation Sequence (CES) should provide channel estimation of each transmitter.
- In all those parts, known sequences with good autocorrelation should be used, such as m sequences or Golay sequence.
- The Header contains essential information such as payload size, modulation, and coding (if used) in the payload.

Simulation Results - Scenario 1 (1/6)

- First, we consider Scenario 1 (IEEE P802.15-15-0746-01-007a) where channel response is measured at 24 different points.

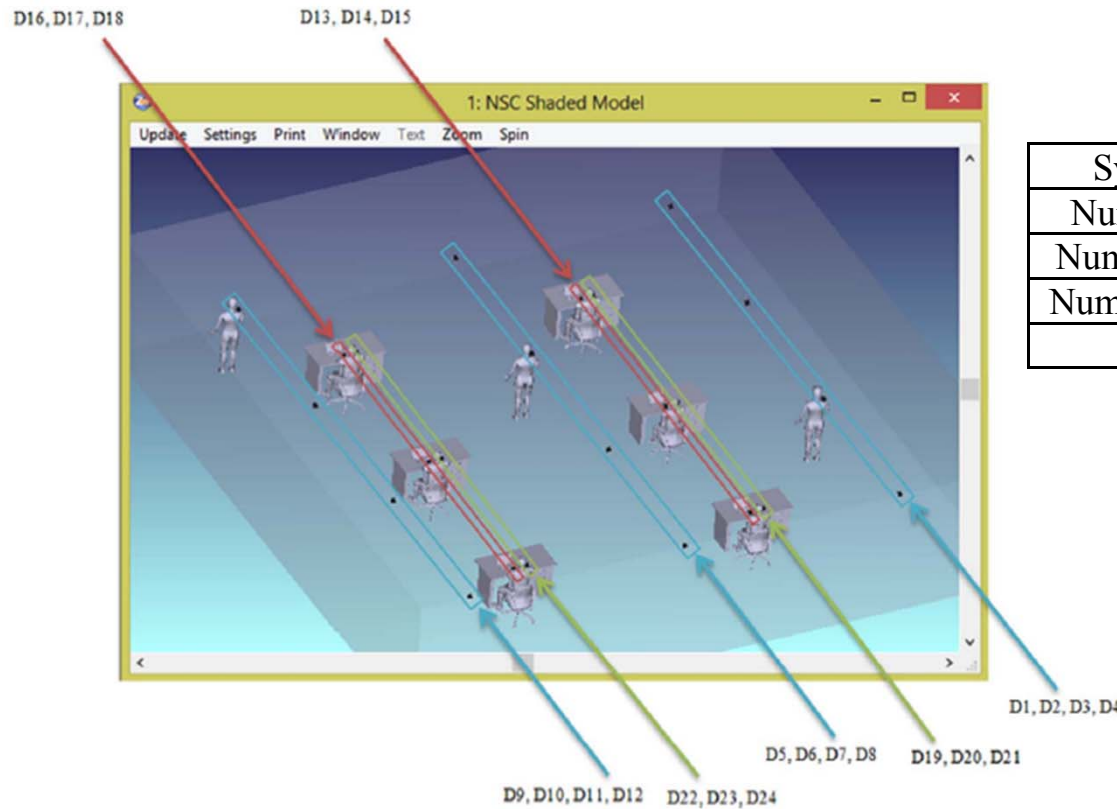

System Parameters

System Bandwidth	20 MHz
Number of Subcarrier	256
Number of Data Carrier	96
Number of Cyclic Prefix	12
Target BER	10^{-3}

Simulation Results - Scenario 1 (2/6)

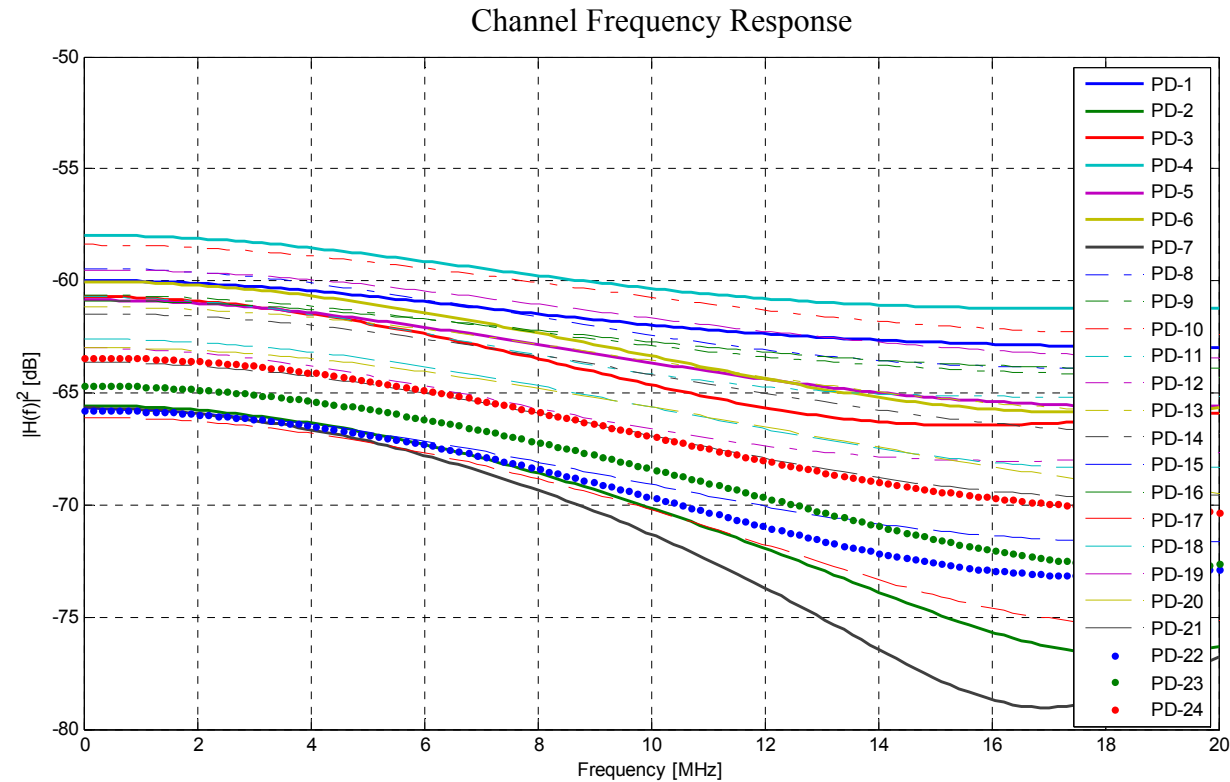

- Large variations in channel gains with respect to locations
 - Best channel conditions: D4, Worst channel conditions: D7
- This necessitates the use of *adaptive transmission*.

Simulation Results - Scenario 1 (3/6)

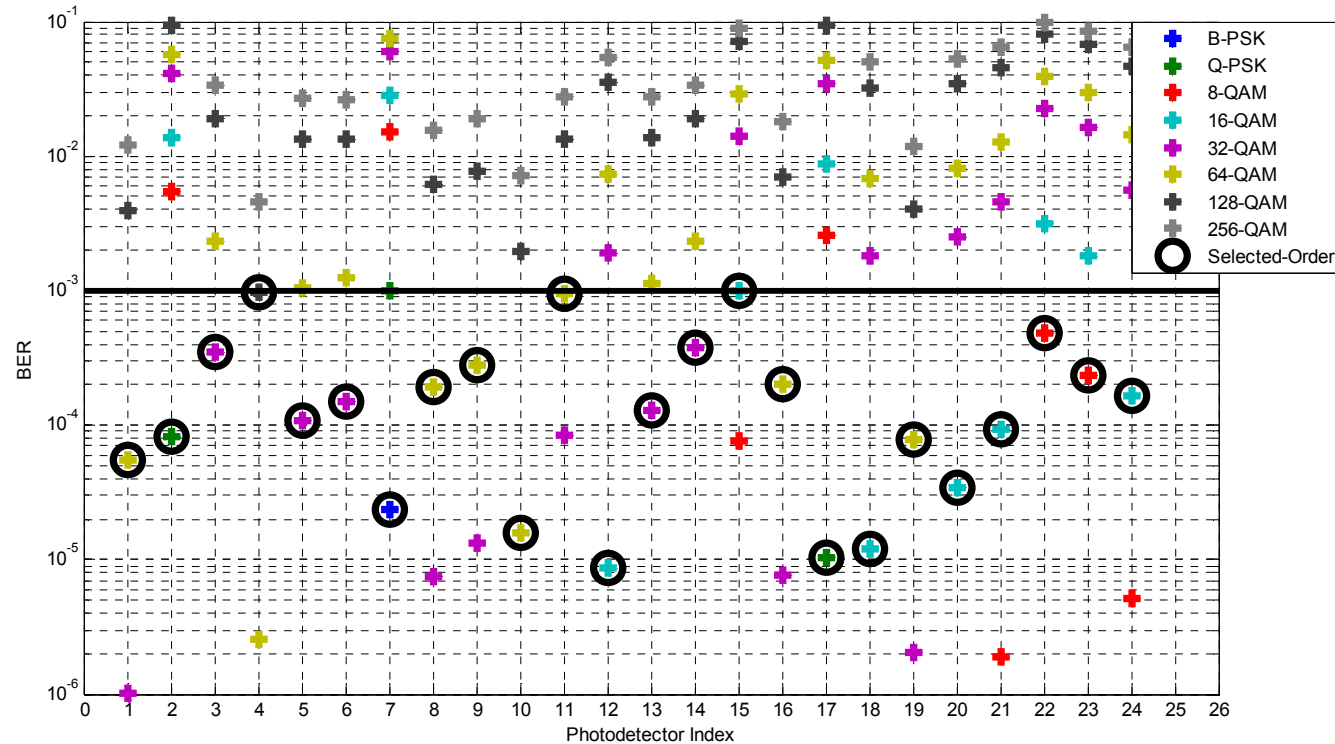

- At each location, the highest modulation order which satisfies target BER is selected. For example at D4, 128-QAM can be deployed since it satisfies the target BER. However, at D7, BPSK should be deployed.

Simulation Results - Scenario 1 (4/6)

- The peak rates (with adaptive modulation) of a user walking through these points are shown below.

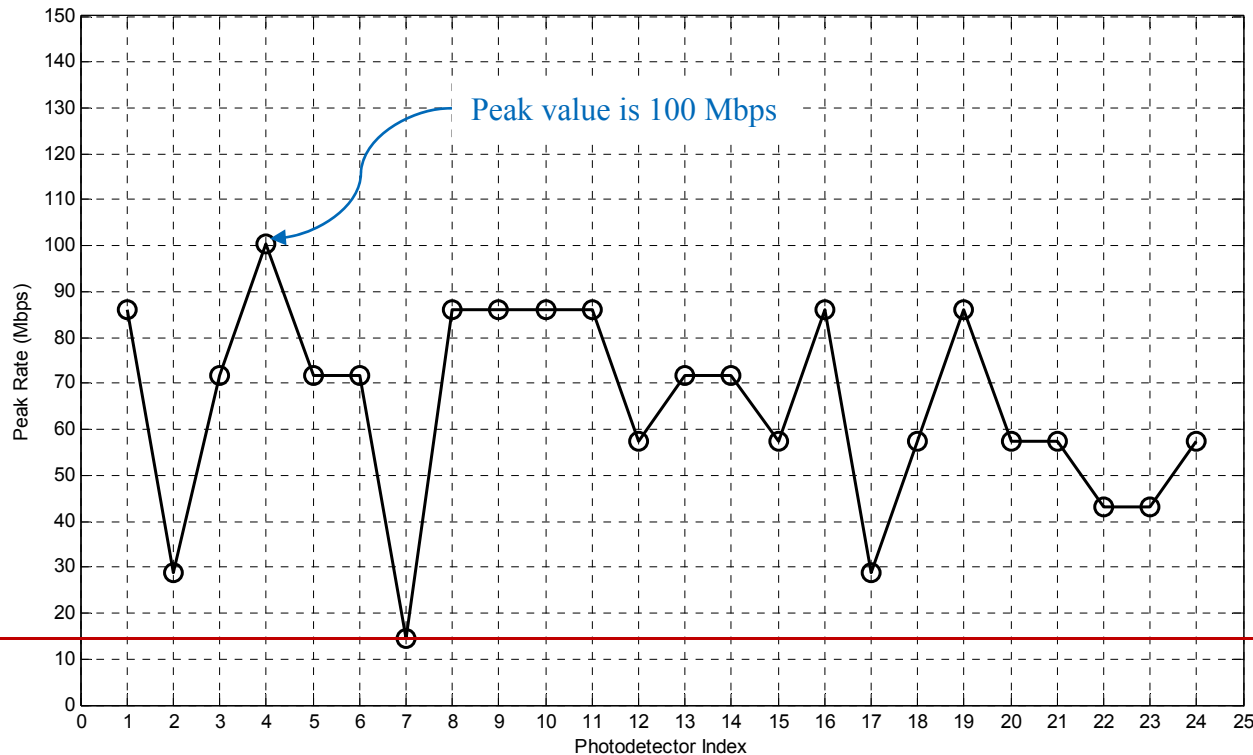

- Worst case design provides only 14 Mbit/s.
- Significant improvements are achieved through adaptive transmission. Peak rate reaches to 100 Mbit/s.

Worst case design: 14.33 Mbps

Simulation Results - Scenario 1 (5/6)

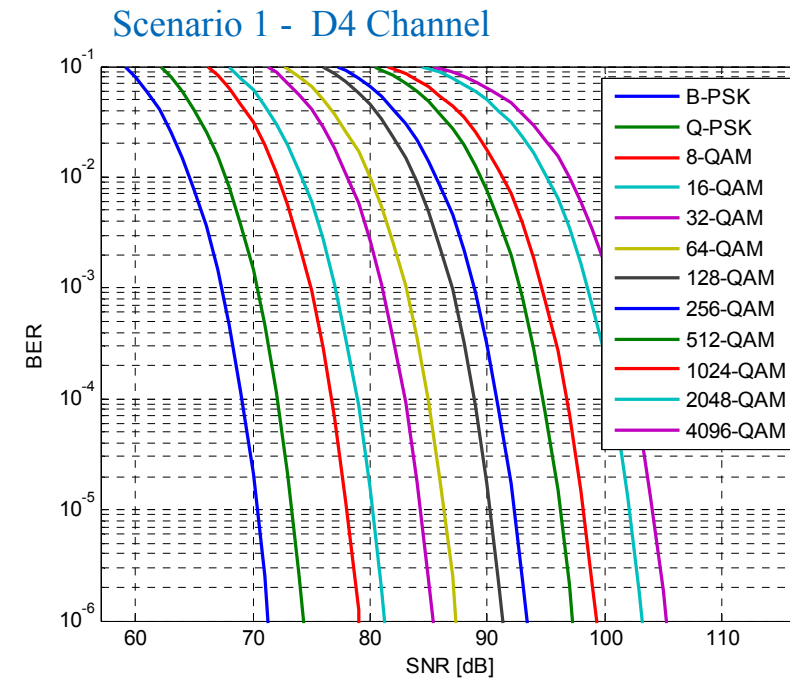
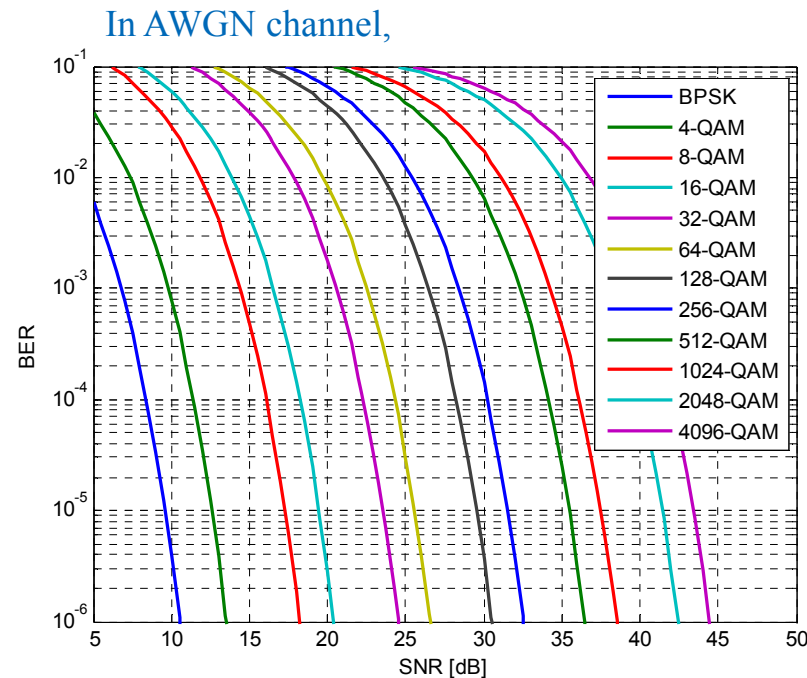

- At D4, the path loss is around -60 dB
- At a given SNR value, the modulation order which gives the highest peak rate, while satisfying target BER, is deployed in transmission. The achieved data rates are plotted next.

Simulation Results - Scenario 1 (6/6)

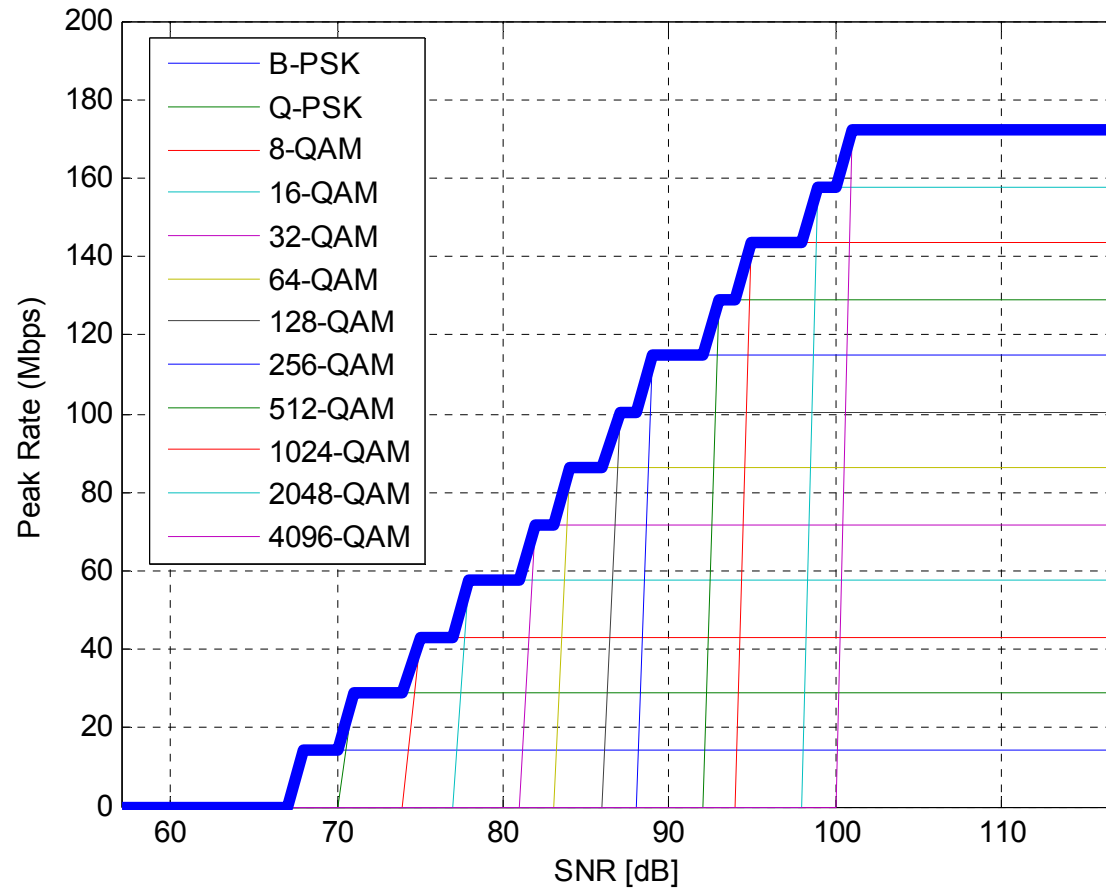

Modulation	SNR [dB]
BPSK	67
QPSK	70
8-QAM	75
16-QAM	77
32-QAM	81
64-QAM	83
128-QAM	87
256-QAM	89
512-QAM	93
1024-QAM	95
2048-QAM	99
4096-QAM	101

Simulation Results - Scenario 4 (1/10)

- Scenario 4 (IEEE P802.15-15-0746-01-007a) with multiple transmitters are used for simulations.
- Repetition code and spatial multiplexing are considered as MIMO types.

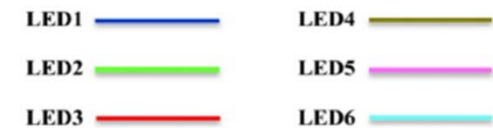
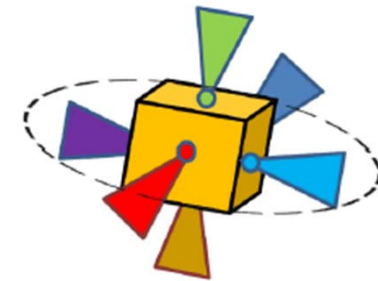
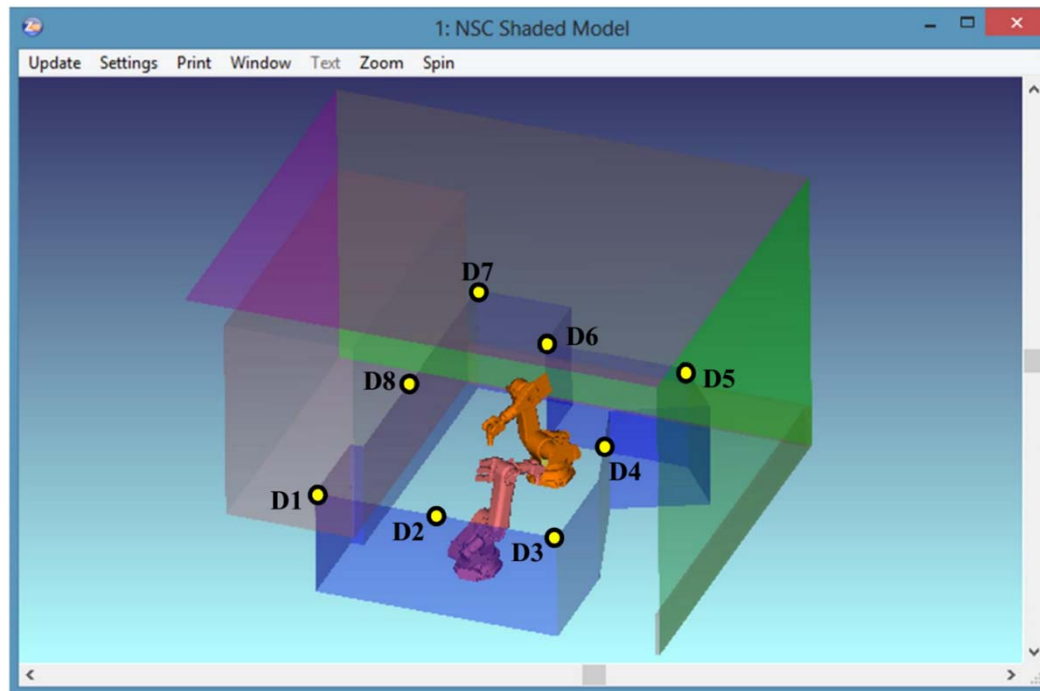

Simulation Results - Scenario 4 (2/10)

System Parameters

System Bandwidth	20 MHz	200 MHz
Number of Subcarrier	256	2048
Number of Data Carrier	96	960
Number of Cyclic Prefix	12	96
Target BER	10^{-3}	10^{-3}

- Maximum likelihood (**optimal**) decision rule is used for RC
- Zero forcing (**not optimal but simple**) is used for SMUX.

Simulation Results - Scenario 4 (3/10)

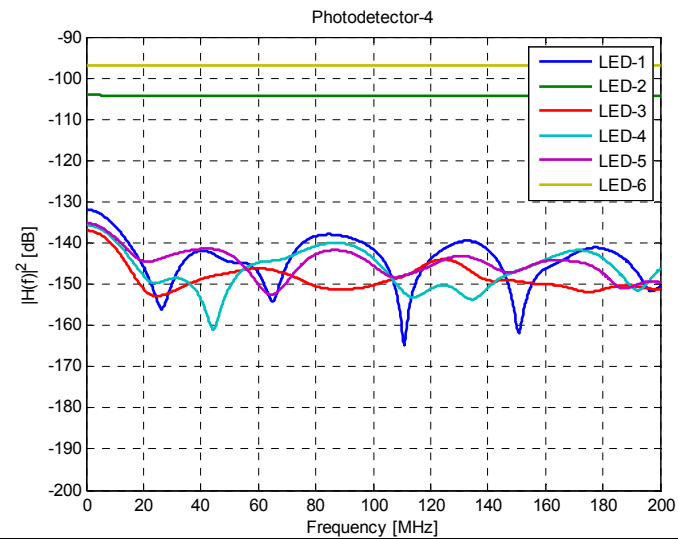
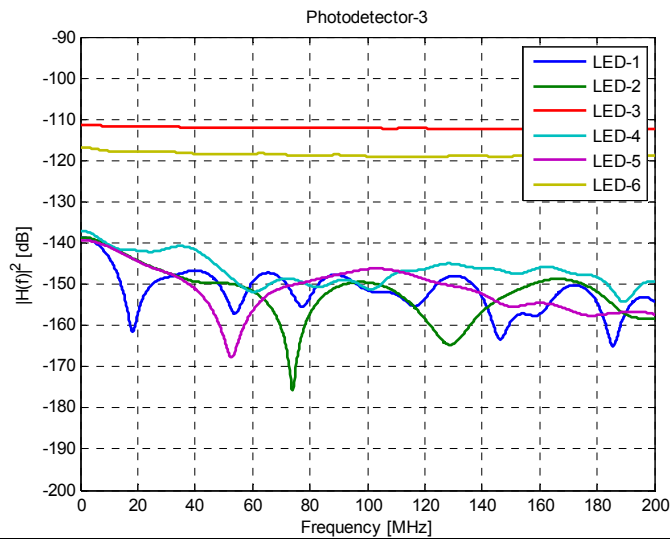
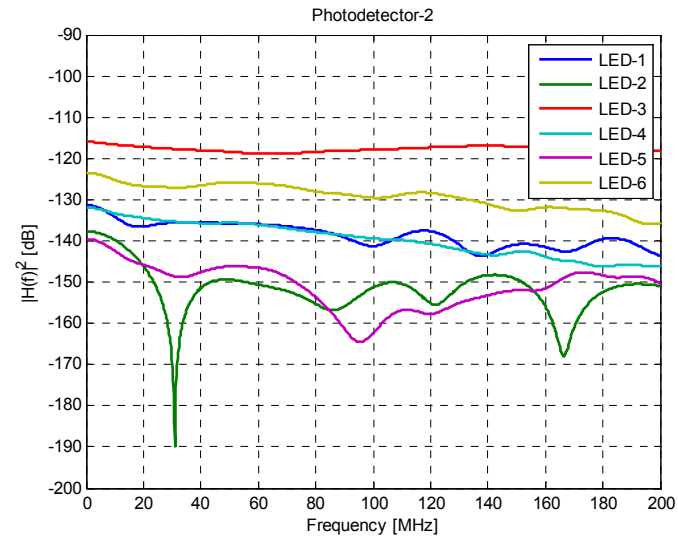
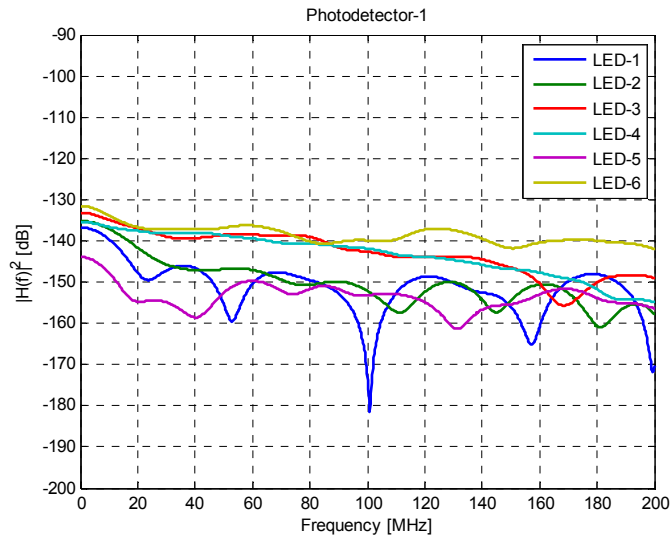

Simulation Results - Scenario 4 (4/10)

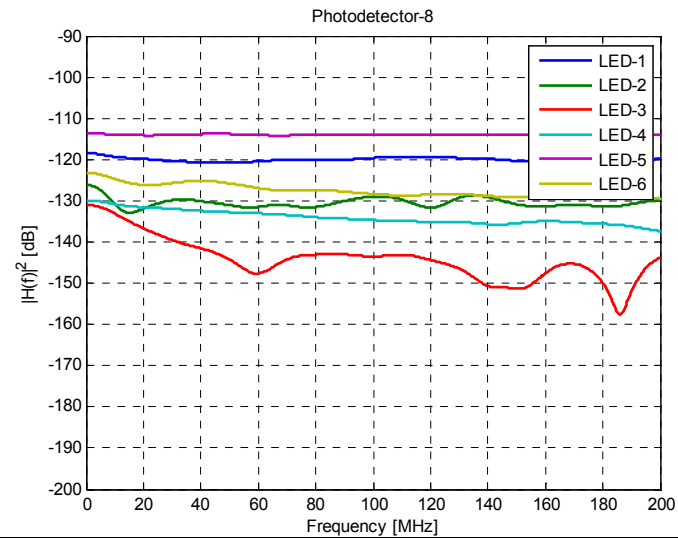
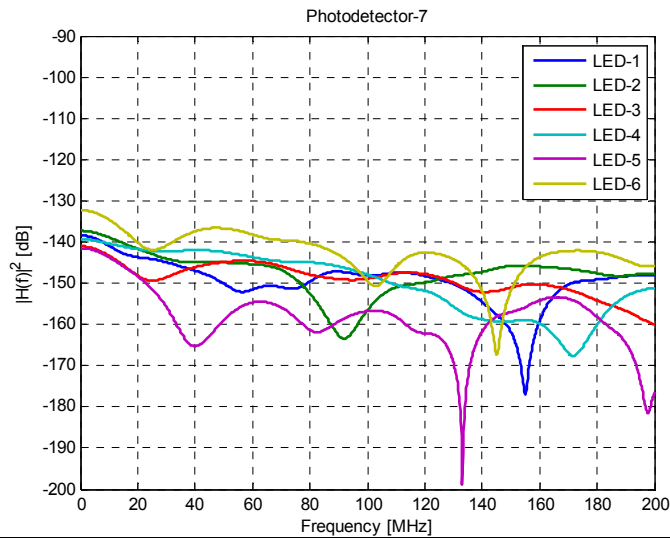
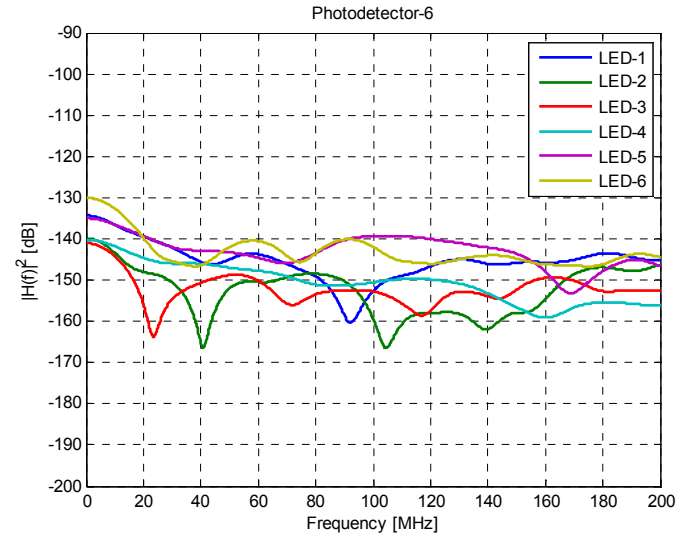
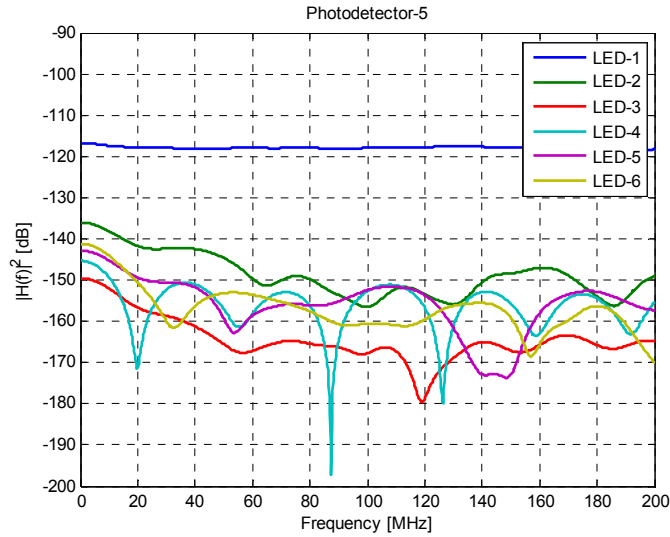

Simulation Results - Scenario 4 (5/10)

2x2 MIMO systems ($B=20$ MHz)

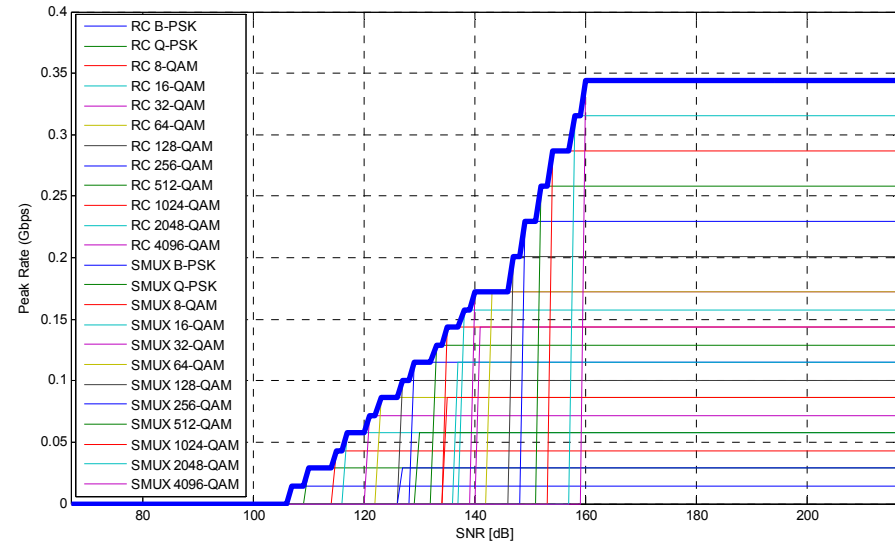
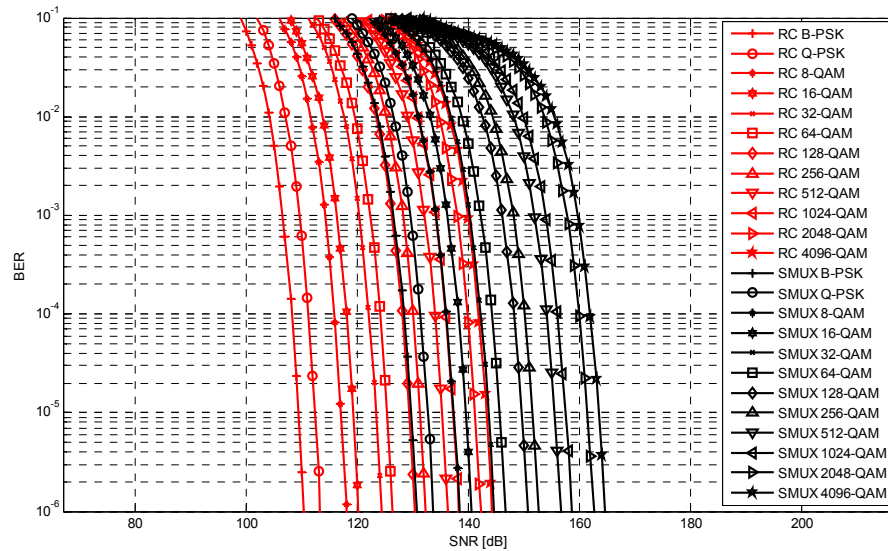

- With adaptive MIMO, a data rate of 344 Mbits/s is achieved.

Simulation Results - Scenario 4 (6/10)

4x4 MIMO systems ($B=20$ MHz)

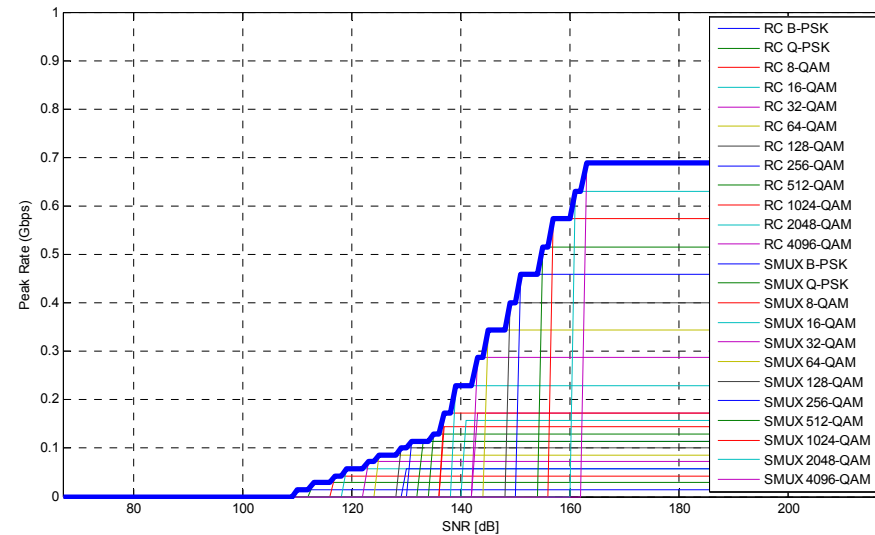
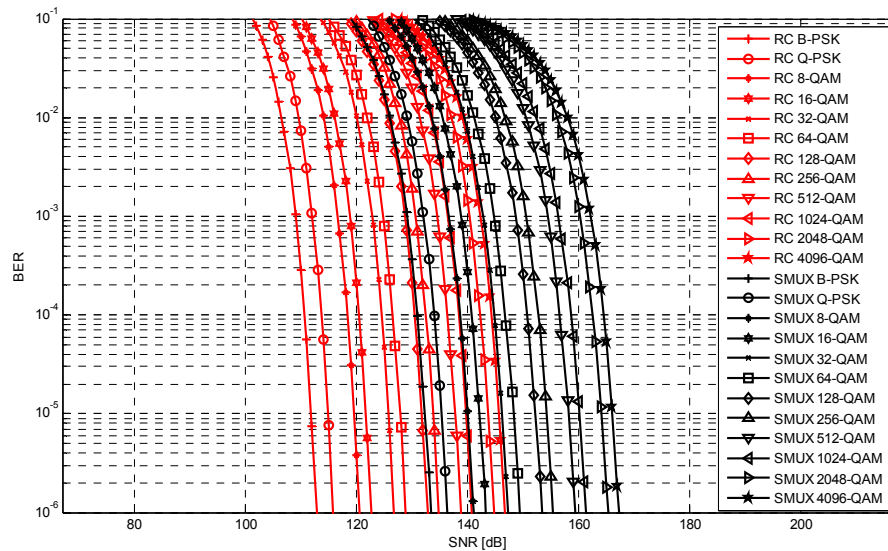

- With adaptive MIMO, a data rate of 688 Mbps data rate is achieved.
- Under the same spectral efficiency, RC suffers from high modulation order and SMUX is required to get better performance. For example,
 - RC with 16-QAM outperforms SMUX with BPSK
 - RC with 256-QAM outperforms SMUX with QPSK
 - SMUX with 8-QAM outperforms RC 4096-QAM !

Simulation Results - Scenario 4 (7/10)

6x6 MIMO systems ($B=20$ MHz)

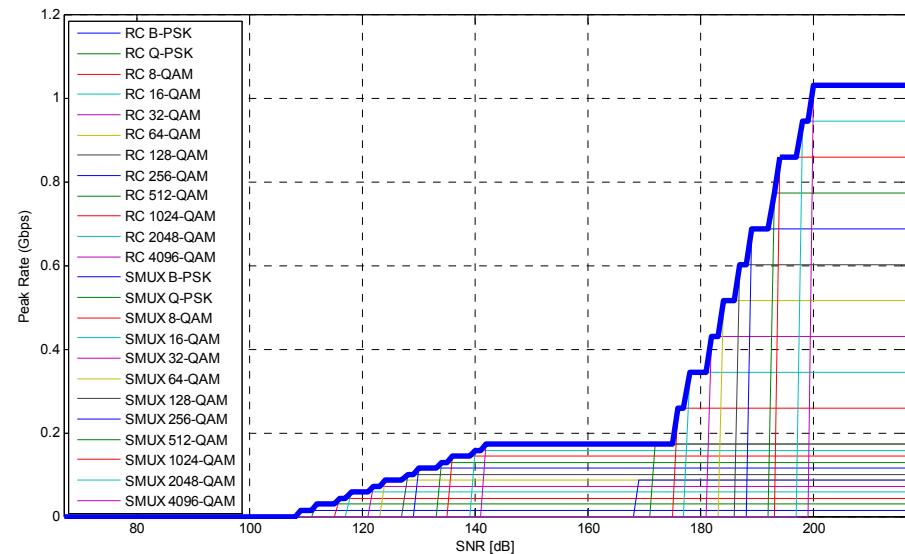
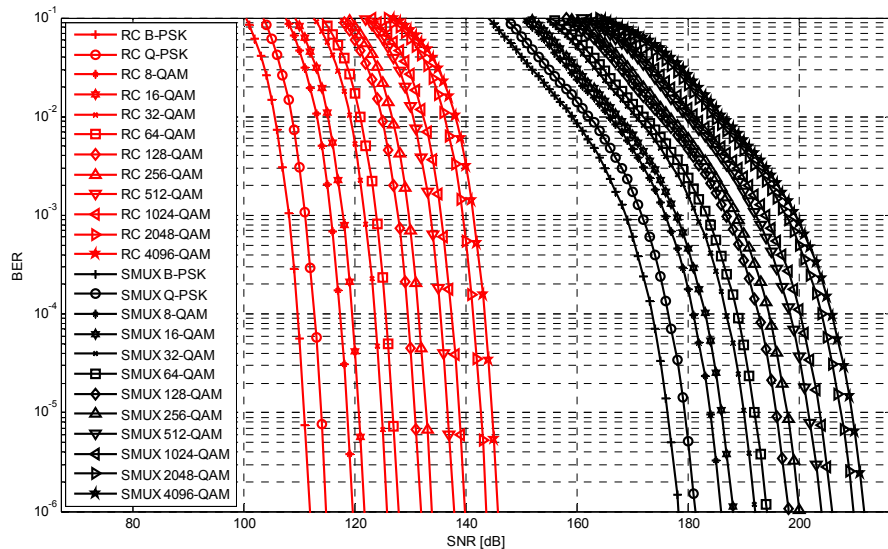

- With adaptive MIMO, a data rate of 1 Gbit/s is achieved.
- SMUX suffers from channel correlations. Maximum likelihood decoder and/or coding are required to improve the performance.

Simulation Results - Scenario 4 (8/10)

2x2 MIMO systems ($B=200$ MHz)

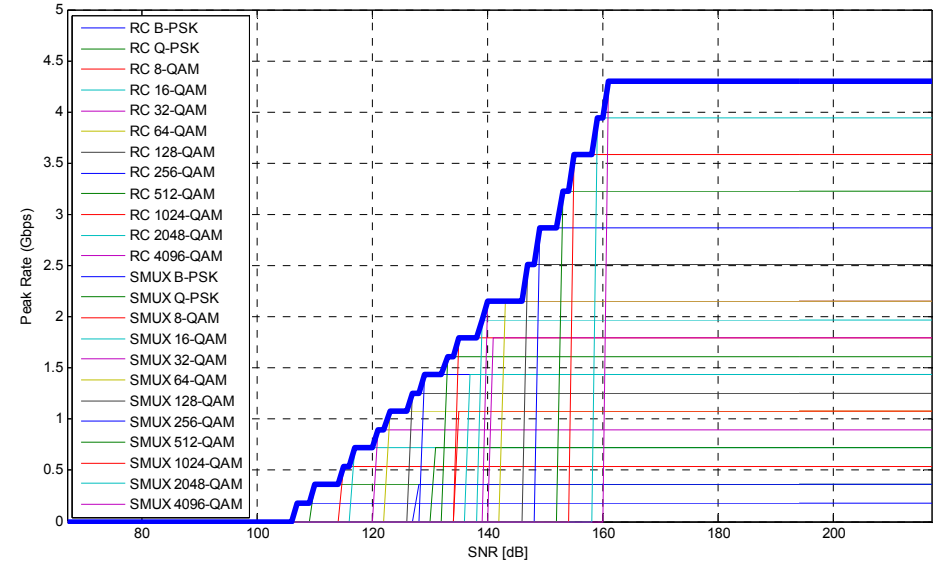
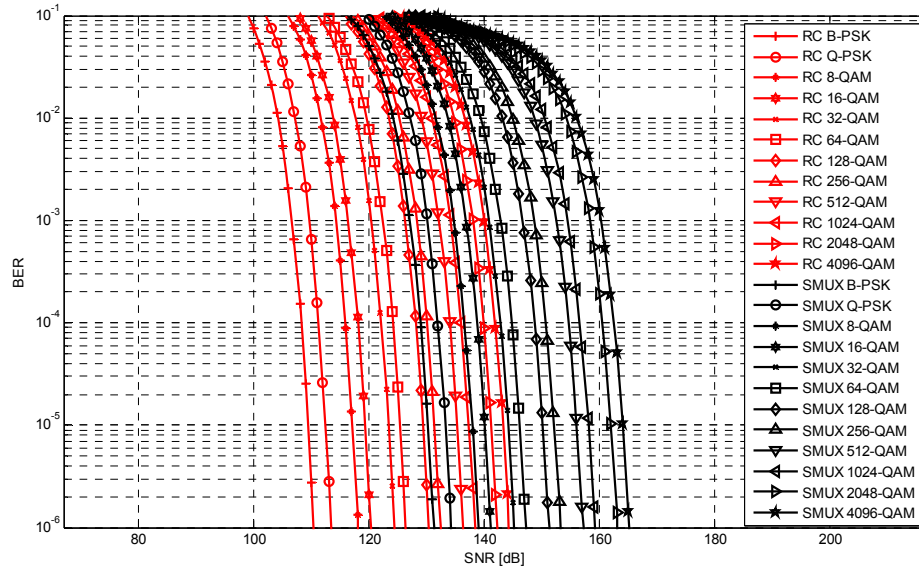

- With adaptive MIMO, a data rate of 4.3 Gbit/s is achieved.

Simulation Results - Scenario 4 (9/10)

4x4 MIMO systems ($B=200$ MHz)

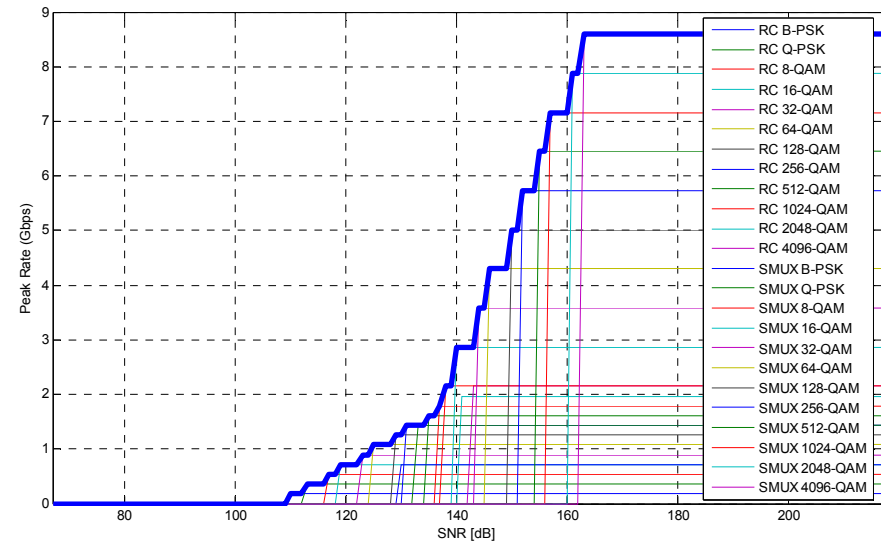
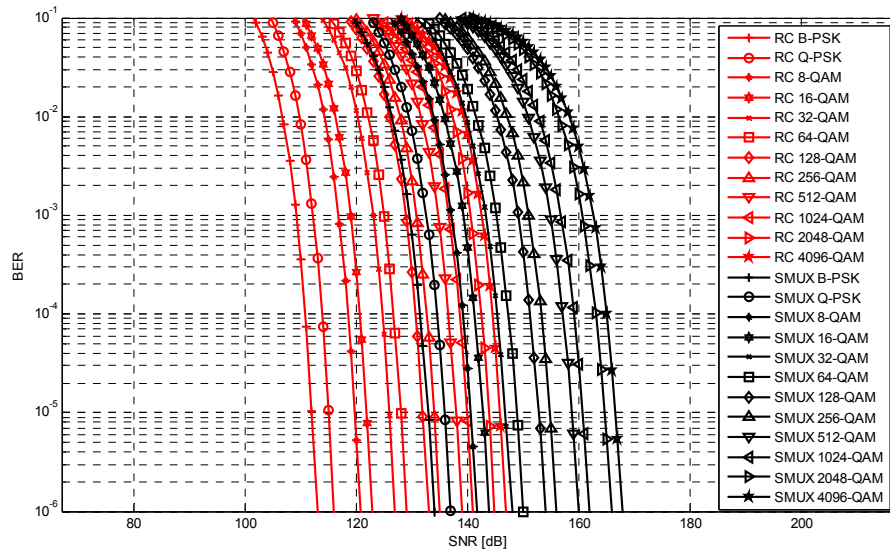

- With adaptive MIMO, a data rate of 8.6 Gbit/s is achieved.

Simulation Results - Scenario 4 (10/10)

6x6 MIMO systems ($B=200$ MHz)

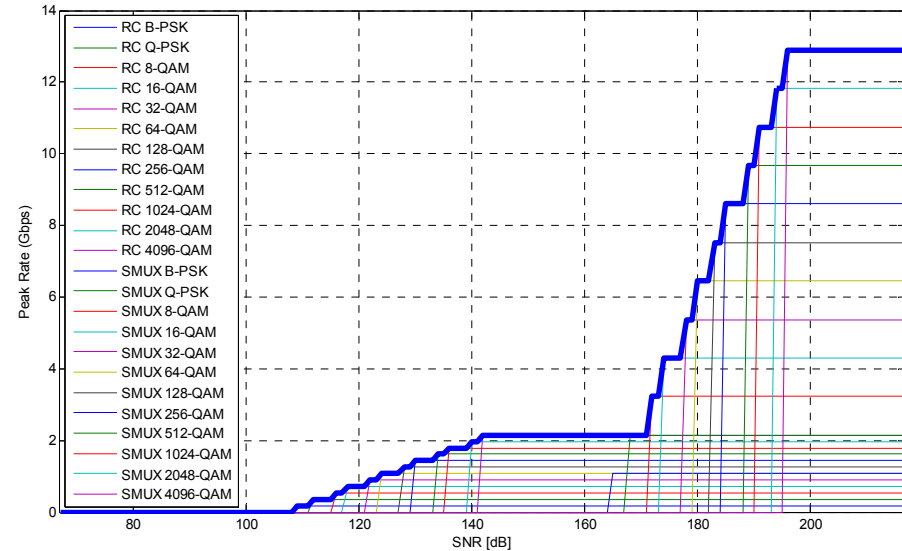
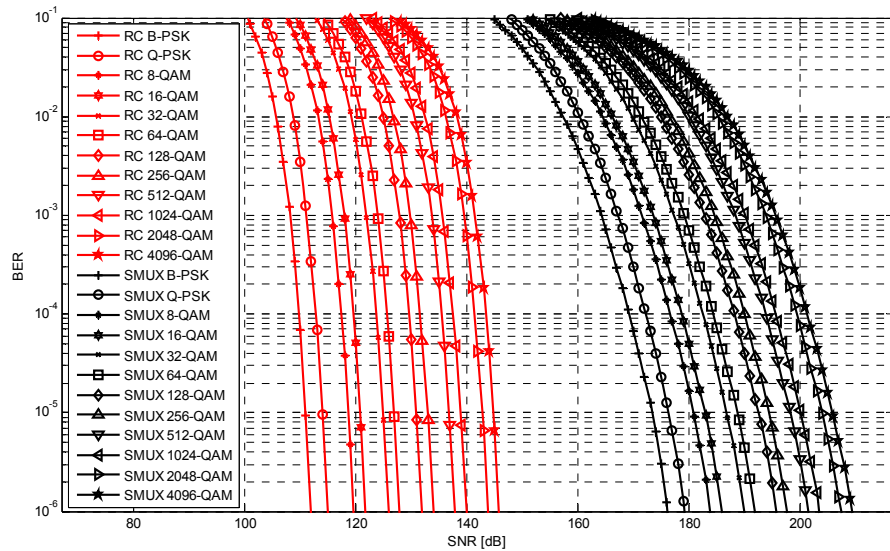

- Targeted data rate of 10 Gbit/s is achieved via SMUX & 1024-QAM.

Conclusions

- We proposed the use of adaptive MIMO OFDM.
- In the proposed system, each transmission mode (TM) is a unique combination of a) MIMO configuration, b) MIMO type, c) Modulation type, d) Modulation order.
- With the choice of optimal parameters according to channel conditions, targeted rates of 10 Gbit/s envisioned in IEEE 802.15.7r1 TCD Document can be satisfied.

Acknowledgments

- The work of authors M. Uysal and T. Baykas is carried out as an activity of “Optical Wireless Communication Excellence Centre” funded by Istanbul Development Agency (ISTKA), Innovative Istanbul Financial Support Program 2015 (TR10/15/YNK-72 OKATEM).