IEEE P802.15
Wireless Personal Area Networks

Project	IEEE P802.15 Working Group for Wireless Personal Area Networks (WPANs)	
Title	MSK with FEC PHY proposal for IEEE 802.15.4q	
Date Submitted	4 November 2013	
Source	Frederik Beer Jörg Robert	Voice: +4991318525123 Fax: ++4991318525102 E-mail: frederik.beer@fau.de joerg.robert@fau.de
Re:	IEEE 802.15 TG4q	
Abstract	TG4q – MSK with FEC PHY proposal for IEEE 802.15.4q	
Purpose	To explain the MSK with FEC PHY layer proposal submitted in response to the call for proposal (CFP) from IEEE 802.15.4q	
Notice	This document has been prepared to assist the IEEE P802.15. It is offered as a basis for discussion and is not binding on the contributing individual(s) or organization(s). The material in this document is subject to change in form and content after further study. The contributor(s) reserve(s) the right to add, amend or withdraw material contained herein.	
Release	The contributor acknowledges and accepts that this contribution becomes the property of IEEE and may be made publicly available by P802.15.	

Content

MSK with FEC PHY Layer proposal for IEEE 802.15.4q	3
1. Introduction	3
1.1 Scenarios and Motivation	3
2. Parts of the PHY Layer	5
2.1 PPDU format for MSK	5
2.1.1 Preamble Field	5
2.1.2 SFD	5
2.1.3 PHR	5
2.1.4 PSDU Field	5
2.2 Modulation and coding for MSK.....	5
2.2.1 Reference modulator diagram	5
2.2.2 Forward Error Correction.....	6
2.2.2.1 Constraint Length 4 Code	6
2.2.2.2 Constraint Length 7 Code	6
2.2.3 Code-Bit interleaving	6
2.2.4 Data whitening.....	7
2.2.5 MSK Pre-Coding	7
2.2.6 MSK Modulation.....	7
2.3 MSK PHY RF requirements.....	7
2.3.1 Operating Frequency range and bit rates	7
2.3.2 Radio frequency tolerance.....	7
2.3.3 Transmit Power	7
3. Parts of the MAC Layer	8
3.1 General MAC Frame	8
3.2 Beacon Frame.....	8
4. Evaluation	9
4.1 Power Consumption	9
4.2 Bit Error Rate.....	10
4.3 Datarate	12
4.4 Transmit Power	14
4.5 Link Budget Calculations	17
References	18

MSK with FEC PHY Layer proposal for IEEE 802.15.4q

1. Introduction

The scope of the IEEE 802.15.4q amendment is to enable the IEEE 802.15.4 standard family for applications with ultra low power (ULP) requirements. The main driving force behind this aim is the wish to have IEEE 802.15.4 compliant transceiver chips running from coin cell batteries, energy harvesting or other limited power supplies.

This document addresses the modulation, coding schemes and necessary changes related to that required by the IEEE 802.15.4q physical layer. Additionally it provides simulation results on the performance of the proposed modulation and coding schemes.

1.1 Scenarios and Motivation

Many applications can be targeted for an ULP standard. For exemplary discussion and motivation smart labels will be picked as one suitable application. In Fig. 1 a so called hypermarket can be seen with a vast number of products and shelves. Traditionally, for each group of products a label has to be attached to the shelf with current pricing and further information. Smart labels try to address this application by providing an easier way of managing prices and product information. The traditional paper label is replaced by an electronic label with wireless communication capabilities. Obviously, an ULP approach is desirable for such an application as the smart labels can only host a very limited power supply due to size constraints. Additionally, if the battery lifetime is not sufficiently high, the replacement of the smart labels will overcome the cost reduction introduced in the first place. A IEEE 802.15.4 ULP standard should harmonise already available systems for smart labels, leading to lower prices for such systems.

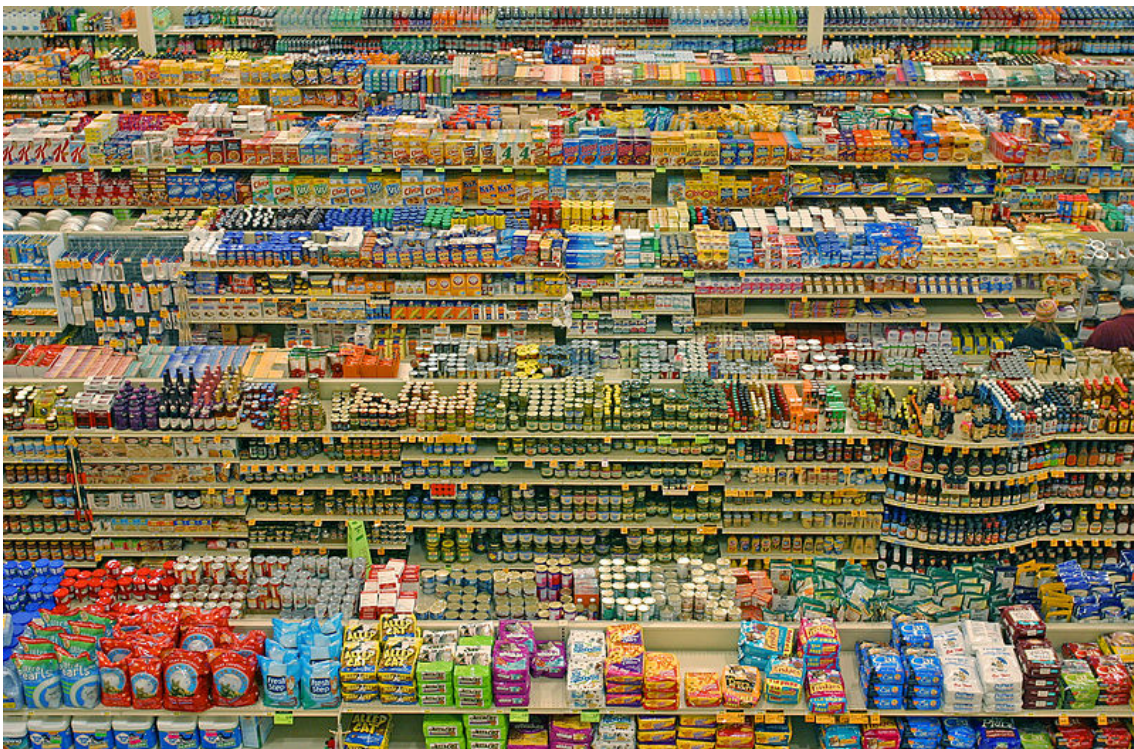

Figure 1: Shelves in a hypermarket (CC BY-SA 2.0, Original author: lyzadanger; Derivative work: Diliff)

Fig. 2 shows warehouse which represents a similar scenario. For the operator it is desirable to have an easy approach for real-time inventory. For that purpose each palette or even each box could be equipped with a smart label. The same ULP requirements as for the former scenario apply here.



Figure 2: Pallets in a warehouse

At both scenarios the transmission between the smart labels and the concentrators can be regarded as highly asymmetric. While the smart labels are extremely limited in available power and complexity, the concentrators may have bigger batteries (or are even mains-powered) and higher processing complexity.

In order to address this asymmetry the proposed complex forward error correction (FEC) scheme can be used in the uplink (i.e. from the smart label to the concentrator) – since convolutional encoding is a simple task compared with decoding – whereas in the downlink the concentrator transmits with a simpler FEC or even without any FEC and compensates the missing coding gain by higher transmit power. This situation is depicted in Figure 3. A link budget calculation for this situation is presented in section 4.5.

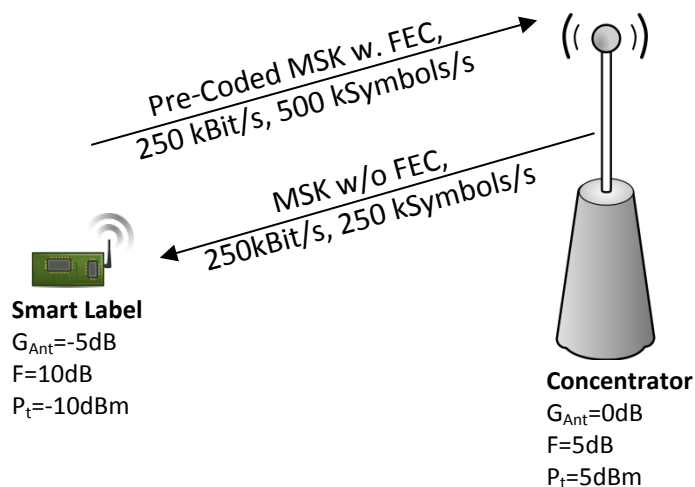

Figure 3: Up-/downlink asymmetry between smart label and concentrator

2. Parts of the PHY Layer

This proposal mostly builds upon elements already available in IEEE 802.15.4-2011 standard and the amendments 4e, 4g and 4k. New elements and features are only introduced where deemed necessary and useful.

2.1 PPDU format for MSK

2.1.1 Preamble Field

The preamble field shall contain two multiples of the 8-bit sequence "01010101".

2.1.2 SFD

The SFD shall be the 2-octet sequence as shown in Table 1. The sequence depends on the mode of the forward error correction (FEC), which allows for a detection of the used FEC mode within the receiver

Table 1 – SFD value

Octets	1	2
Bit map w/o FEC	1110 1110	1101 0010
Bit map with FEC K=4	0110 0110	0100 1011
Bit map with FEC K=7	1001 1001	1011 0111

2.1.3 PHR

No changes to the PHR.

2.1.4 PSDU Field

The PSDU shall carry the payload of the PPDU. The maximum size of an PSDU shall be 63 octets.

2.2 Modulation and coding for MSK

2.2.1 Reference modulator diagram

Figure 4 depicts the modulator block diagram of the proposed system. The shaded blocks are already used within the IEEE 802.15.4 standard family and are used within this proposal without any modification. The following sub-sections give the functional description of the blocks.

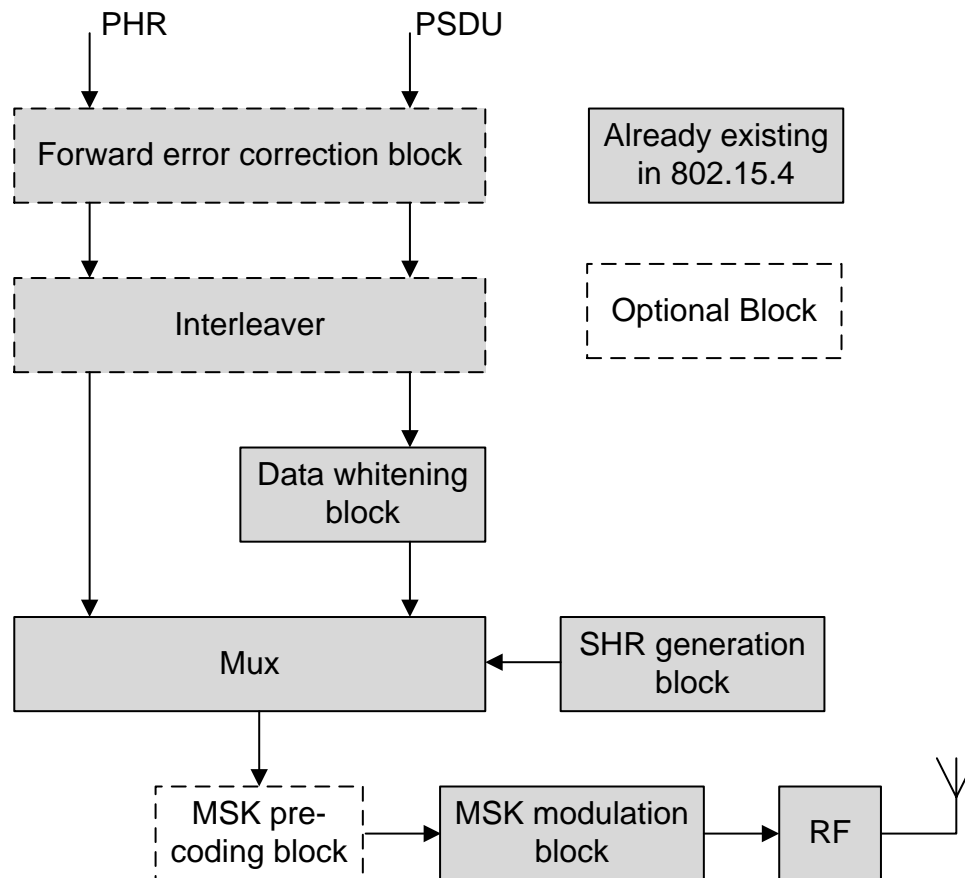

Figure 4 – Modulator reference block diagram

2.2.2 Forward Error Correction

The use of the Forward Error Correction (FEC) is optional and its application depends on the decoding performance of the receiver. The encoding procedure itself is of low complexity and thus should not provide any challenge for ULP transmitters.

2.2.2.1 Constraint Length 4 Code

The constraint length $K=4$ code shall be the 1/2-rate convolutional code as defined in section 18.1.2.4 of the IEEE 802.15.4g amendment. Its generator polynomials are:

$$G_0(x) = 1 + x + x^2 + x^3 \text{ and } G_1(x) = 1 + x^2 + x^3$$

2.2.2.2 Constraint Length 7 Code

The constraint length $K=7$ code shall be the 1/2-rate convolutional code as defined in section 19.2.2.4 of the IEEE 802.15.4k amendment. Its generator polynomials are:

$$G_0(x) = 1 + x^2 + x^3 + x^5 + x^6 \text{ and } G_1(x) = 1 + x + x^2 + x^3 + x^6$$

2.2.3 Code-Bit interleaving

If FEC encoding is used the proposal shall use the code-bit interleaving as defined in section 19.2.2.5 of the IEEE 802.15.4k amendment.

2.2.4 Data whitening

Data whitening using the so-called PN9 sequence as defined in section 19.2.3 of the IEEE 802.15.4k standard shall be used. The data whitening is mandatory in all modes.

2.2.5 MSK Pre-Coding

The use of MSK pre-coding is optional and shall be only used in addition to FEC encoding.

Classical MSK results in a differential encoding of the transmitted data. However, the resulting differential decoding leads to performance loss of several dB [5]. Therefore, differential pre-coding is proposed that allows for coherent decoding of the data in sophisticated receivers, which results in the highest possible performance.

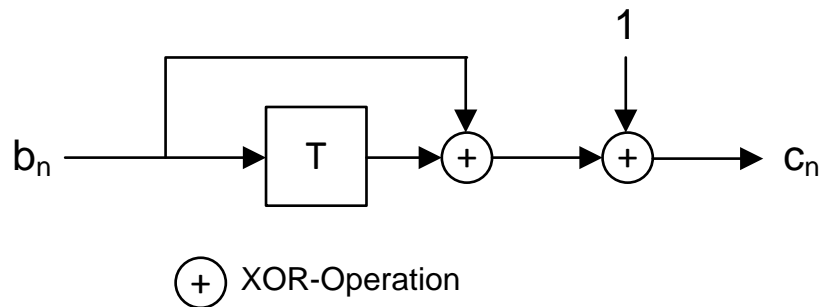

Figure 5 – MSK pre-coding block

Figure 5 shows the function block diagram of the MSK pre-coder with the input sequence b_0, b_1, \dots and the pre-coded output sequence c_0, c_1, \dots . The index 0 starts with the first bit of the SFD, for which the delay element T is initialized with '0'.

The receiver is able to detect whether pre-coding is used by means of the SFD. If the receiver receives a pre-coded SFD, it can assume that pre-coding is used.

2.2.6 MSK Modulation

The modulation of the pre-coded bit-stream c_n shall be FSK with modulation index 0.5 as defined in section 19.2.2 of the IEEE 802.15.4k standard. This modulation index of 0.5 corresponds to MSK (Minimum Shift Keying) modulation.

The supported data rates are 250 kBit/s and 500 kBit/s, which translate to a symbol rate of 500 kSymbols/s and 1 MSymbols/s when using FEC coded transmission respectively.

2.3 MSK PHY RF requirements

2.3.1 Operating Frequency range and bit rates

The proposal supports all frequency bands above and including 433 MHz, e.g. 433 MHz, 868 MHz, 915 MHz and 2.4 GHz.

2.3.2 Radio frequency tolerance

The radio frequency tolerance shall be within ± 50 ppm.

2.3.3 Transmit Power

A compliant device shall be capable of transmitting with a power greater or equal than -10 dBm. The maximum transmitting power should be compliant to the regulatory aspects.

3. Parts of the MAC Layer

3.1 General MAC Frame

We propose the usage of the multipurpose frame as defined in section 5.2.2.6 of the IEEE 802.15.4e amendment. The usage of the multipurpose frame provides maximum freedom in deciding which header fields are absolutely necessary and which fields can be omitted in order to save energy.

The multipurpose frame may carry an according header IE to indicate the usage of an ULP system.

3.2 Beacon Frame

The beacon frame shall carry a header IE in order to signal which decoding methods are supported by the receiver (e.g. the concentrator). Mandatory signaling includes these fields:

- *phyMSKPrecoding*: The boolean variable shall indicate if the concentrator is able to receive precoded MSK signals (cf. section 2.2.5)
- *phySupportedFEC*: This enumeration shall indicate the supported FEC coding schemes (cf. section 2.2.2)

4. Evaluation

4.1 Power Consumption

In [1] the necessary average power for the active mode is given as:

$$P_{on} = \frac{P_t T_{ont}}{T_{ont} + T_{onr}} + \frac{(P_{PA} + P_{ct})T_{ont} + P_{cr}T_{onr}}{T_{ont} + T_{onr}} \quad (1)$$

One proposed way to minimize the average consumed power is to lower the transmit Power P_t , which directly reduced the consumed power.

In order to evaluate not only the average power consumed but the total energy consumed, we remove the normlisation to the on-times:

$$E_{on,tot} = (P_t + P_{PA} + P_{ct})T_{ont} + P_{cr}T_{onr} \quad (2)$$

To minimise the total consumed energy this proposal aims to lower the on-times T_{ont}/T_{onr} by the means of introducing a capable forward error correction scheme.

Other possible optimisation parameters such as the power consumed by the power amplifier or the circuit powers are regarded implementation specific and thus are not considered here.

To reduce the necessary on-times it is possible to either increase the transmission datarate and/or reduce the header introduced overhead.

In the following we will present some evaluations regarding the achievable datarates and transmit powers for transmissions with FEC (coded) and without FEC (uncoded). These evaluations are based on the following equation based upon the findings in [2]:

$$D_b \leq \frac{N_0}{E_{b,RX}} \cdot \frac{P_t}{N_0} \cdot \frac{\lambda^2 \cdot G_{RX} \cdot G_{TX}}{16\pi^2 d^\alpha} \quad (3)$$

D_b : Datarate of the uncoded bits

$E_{b,RX}$: Necessary energy per bit at the receiver

N_0 : Spectral noise density (with noise figure of 10 dB)

P_t : Transmit power

λ : Wavelength (if not stated otherwise for a frequency of 2.4 GHz)

G_{RX}/G_{TX} : Antenna gains (receiver and transmitter)

d : Distance

α : Path loss Exponent

All evaluations regarding datarate have been conducted for two scenarios: An ideal scenario and a more realistic scenario, which differ in the values for the path loss exponent alpha and the gain of the antennas:

Ideal Scenario	Realistic Scenario
$\alpha=2$	$\alpha=3$
$G_{TX} = G_{RX} = 0$ dB	$G_{TX} = G_{RX} = -5$ dB

(Note: The value for the path loss exponent has been chosen to resemble a urban environment cf. [3] p. 139)

4.2 Bit Error Rate

To evaluate the necessary E_b/N_0 at the receiver side for a packet error ratio of 1% at 20 octet PSDUs, several simulations have been conducted with both proposed convolutional forward error correction schemes.

The results for the $R=1/2$, $K=7$ FEC scheme are depicted in Figure 6. Both the bit error ratios (BER) and the packet error ratios (PER) are shown in dashed and solid lines respectively. At the targeted PER of 10^{-2} it can be seen that a E_b/N_0 of 8.67 dB is needed when transmitting without any FEC, whereas with the mentioned FEC and soft decoding the necessary E_b/N_0 drops to 3.2 dB. This results in a coding gain of 5.47 dB.

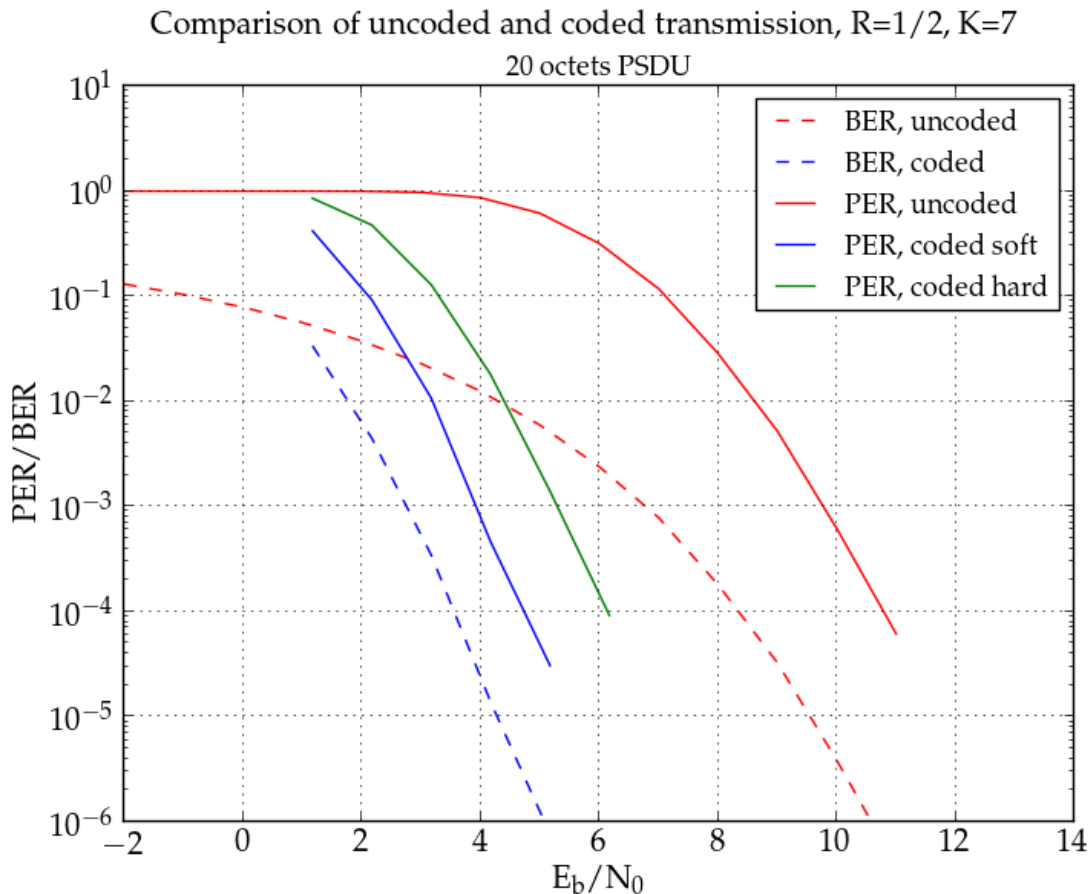

Figure 6: Simulation results for the $R=1/2$, $K=7$ FEC scheme

Figure 7 shows the simulation results for the $R=1/2$, $K=4$ FEC. Obviously the necessary E_b/N_0 for uncoded transmission (@PER 1%) stays at 8.67 dB. The necessary E_b/N_0 for coded transmission with soft decoding is 4.29 dB. This marks a worse performance of 1.09 dB compared to the $K=7$ FEC.

These values for the E_b/N_0 have been used for calculating Eq. (3) in the following sections.

The PER and BER curves have been cross checked with results from [4] and [5] respectively and align with the therein found curves.

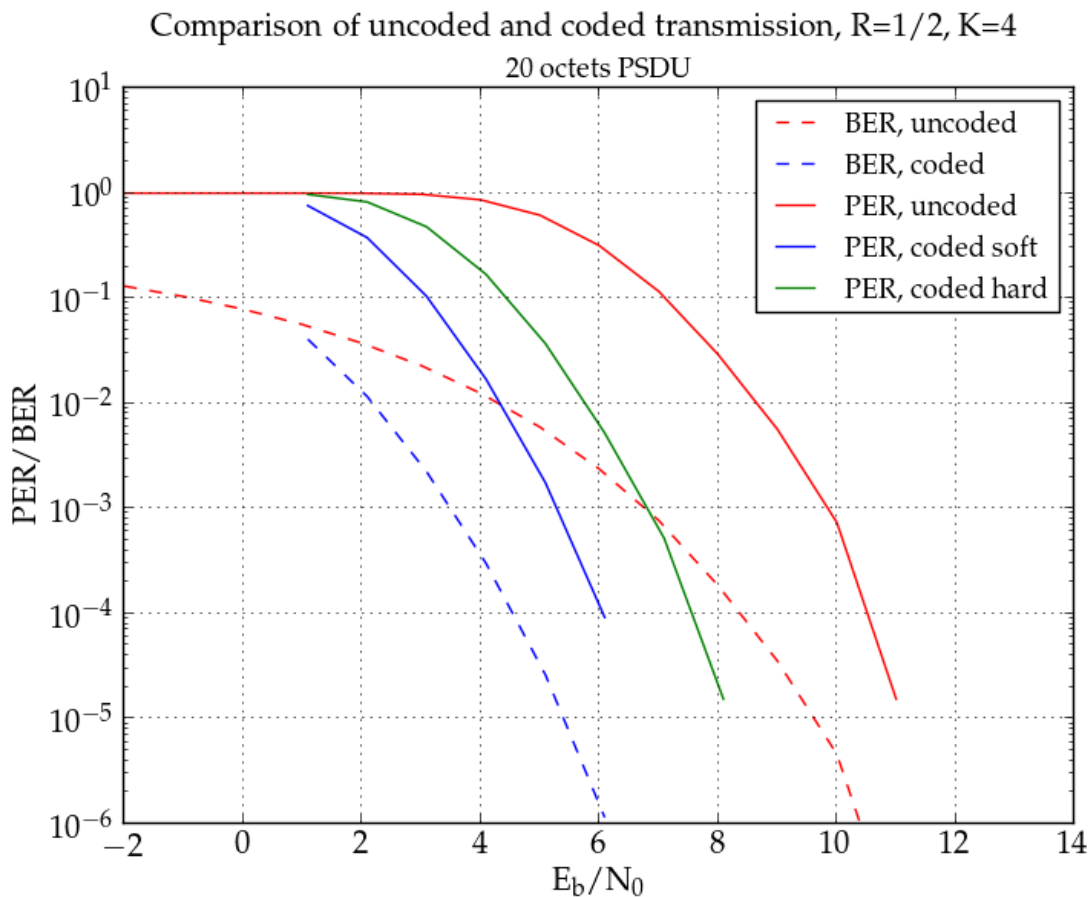

Figure 7: Simulation results for the $R=1/2$, $K=4$ FEC scheme

In Figure 8 we compare the performance of the best case transmission, which is with $R=1/2$ and $K=4$ convolutional code and pre-coding of the MSK modulation (cf. section 2.2.5), with worst case transmission, with no FEC and no pre-coding. As can be seen, the difference regarding the necessary E_b/N_0 for a PER of 1% between both transmissions is 8.77 dB. This plays an important role in asymmetric link communication (cf. Table 3 and Figure 3).

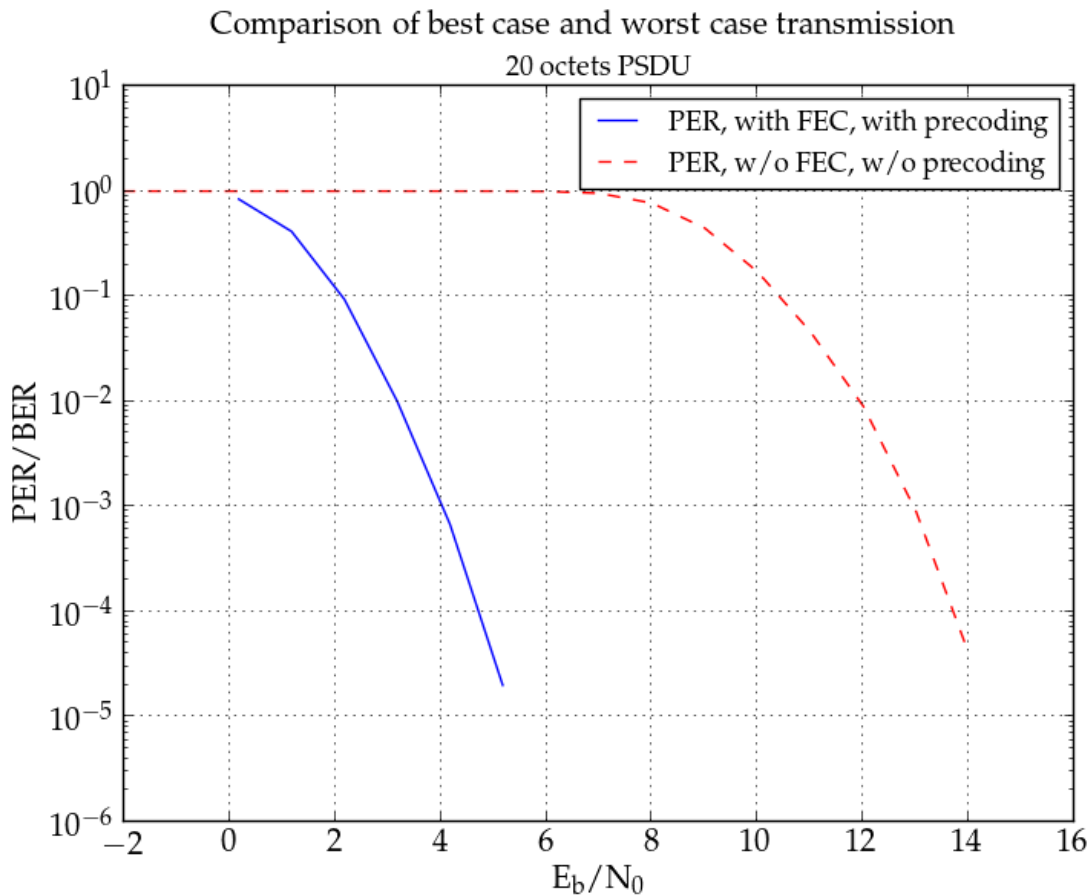

Figure 8: Comparison of worst case transmission (w/o FEC and w/o precoding) and best case transmission (with FEC and with precoding)

4.3 Datarate

Figure 9 shows the results of Eq. (3) plotted as datarate over distance for the ideal scenario and a transmit power at the antenna port of 1 mW. As can be seen in the ideal scenario for a distance of 30 m the achievable datarates are 370 Mbps for the uncoded case, 1 Gbps for K=4 and 1.3 Gbps for K=7. These numbers are obviously highly unrealistic and are only included for comparison.

Figure 10 shows the results for more realistic scenario as described in section 4.1, again with a transmit power of 1 mW. It demonstrates the possibility to increase the datarate when using a coded transmission while keeping a constant transmit power. The datarate can be increased by approx. factor 3.5 (for the K=7 FEC scheme) or factor 2.7 (for the K=4 FEC scheme) compared to the uncoded transmission. This translates to an achievable datarate at a distance of 30 m of 3.4 Mbps (for K=4) and 4.4 Mbps (for K=7). At a distance of 80 m the datarates possible are 180 kbps (for K=4) and 230 kbps (for K=7) compared with 66 kbps for uncoded transmission.

An increase in the datarate of factor 3.5 can directly be translated in a reduction of the necessary time for transmission (and reception) by the same factor, thus reducing the necessary amount of energy for one transmission significantly both on transmitter and receiver side. The following table gives a short overview about the necessary on-times for a transmission of 20 octets at a distance of 80 m:

	No FEC	FEC R=1/2 K=4	FEC R=1/2 K=7
On-time (@80m)	2.4 ms	0.9 ms	0.7 ms

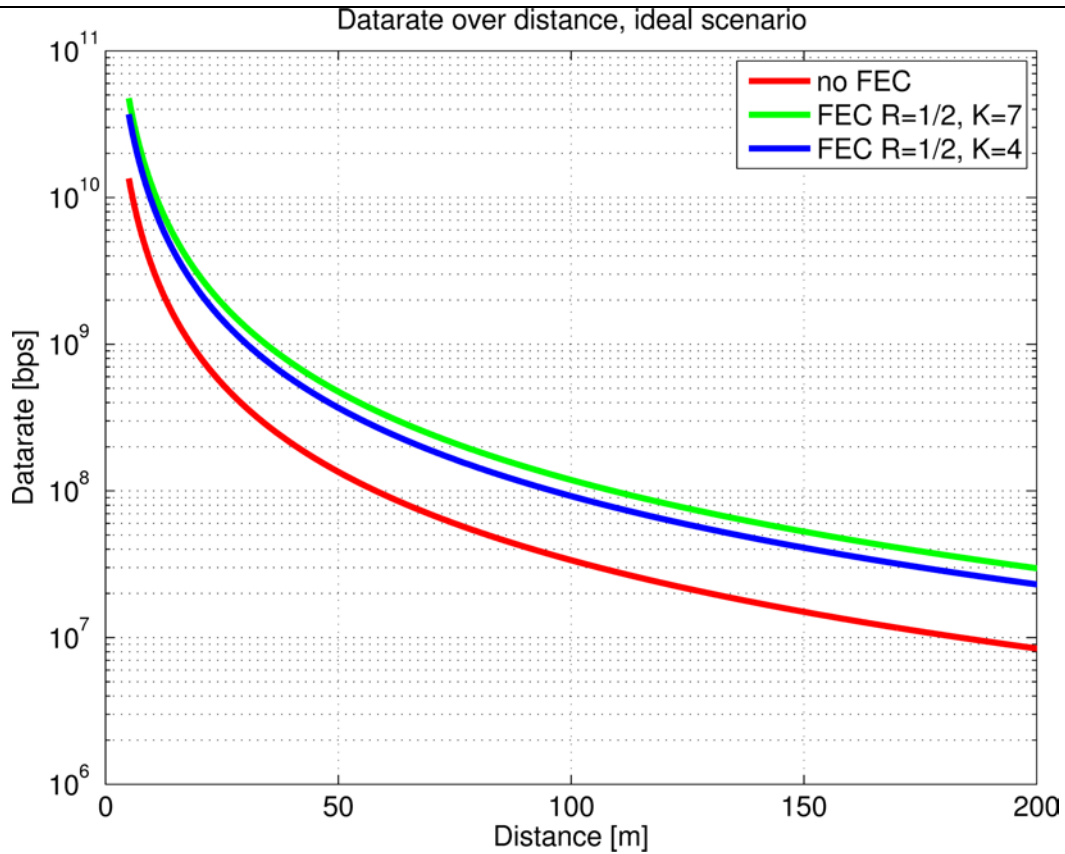

Figure 9: Datarate increase for transmission with FEC R=1/2 K=7 and FEC R=1/2 and K=4 compared with uncoded transmission for an ideal scenario.

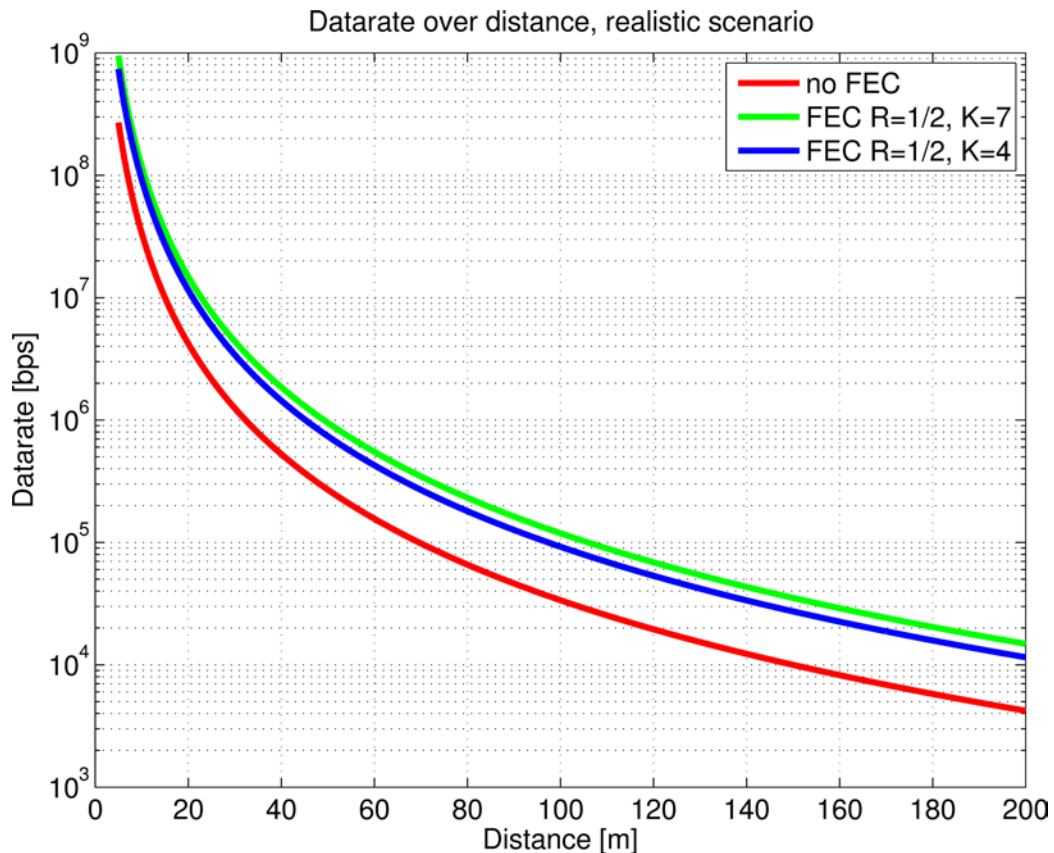

Figure 10: Datarate increase for transmission with FEC R=1/2 K=7 and FEC R=1/2 and K=4 compared with uncoded transmission for a realistic scenario.

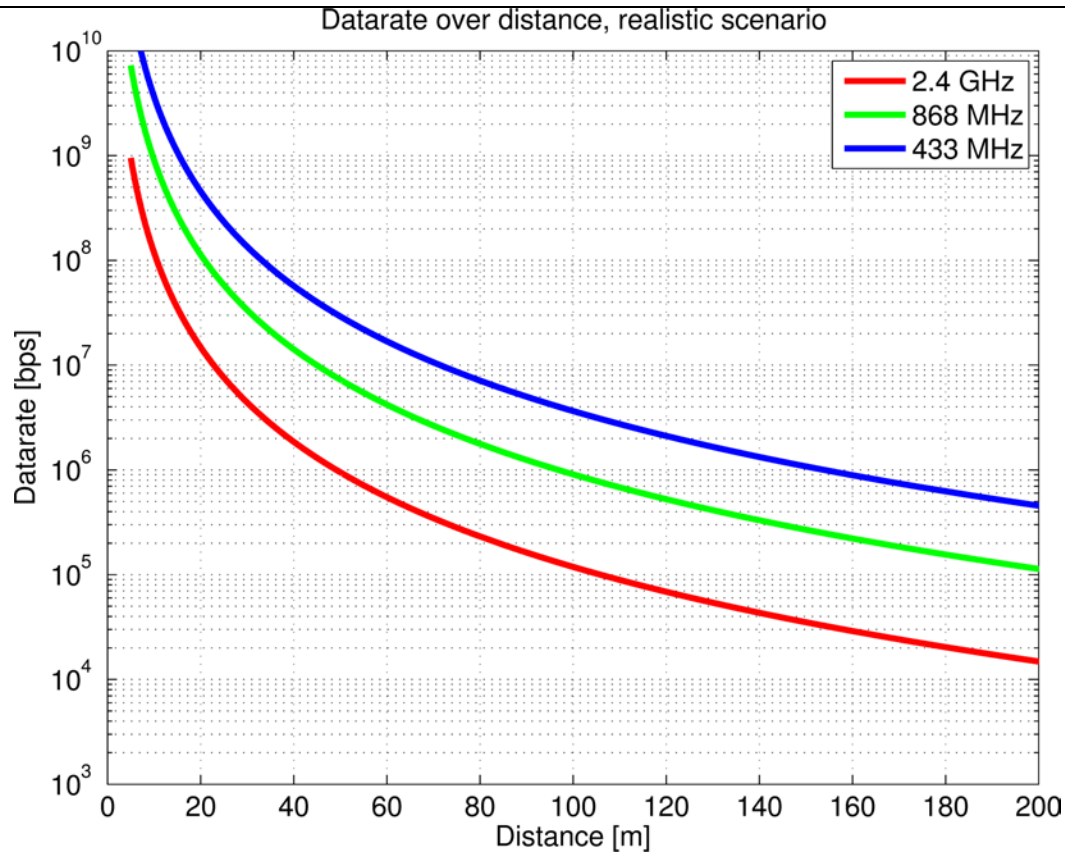

Figure 11: Comparison of achievable datarates for different frequency bands ($P_t=1$ mW, FEC R=1/2 K=7)

Figure 11 depicts the achievable datarates for different frequency bands. As the frequency heavily influences the path loss, the 2.4 GHz band has the highest path loss. For the sub-GHz bands this loss is comparatively low, allowing for higher datarates.

4.4 Transmit Power

If a FEC scheme is used and the datarate remains unchanged the transmit power can be reduced by factor 3.5 (2.7 for K=4) while keeping the E_b/N_0 level constant. This reduces the peak power consumption during transmission. The exact factor of the reduction cannot be given as it is dependent on the other power levels during transmission (cf. Eq. (1)), however the absolute reduction will be at least equal to the reduction in transmission power.

Figure 12 and Figure 13 show the simulation results of a transmission with a transmit power of 1 mW for the uncoded case and a transmit power of 0.3 mW for the FEC R=1/2 K=7. As can be seen the performance are identical despite the reduced transmit power.

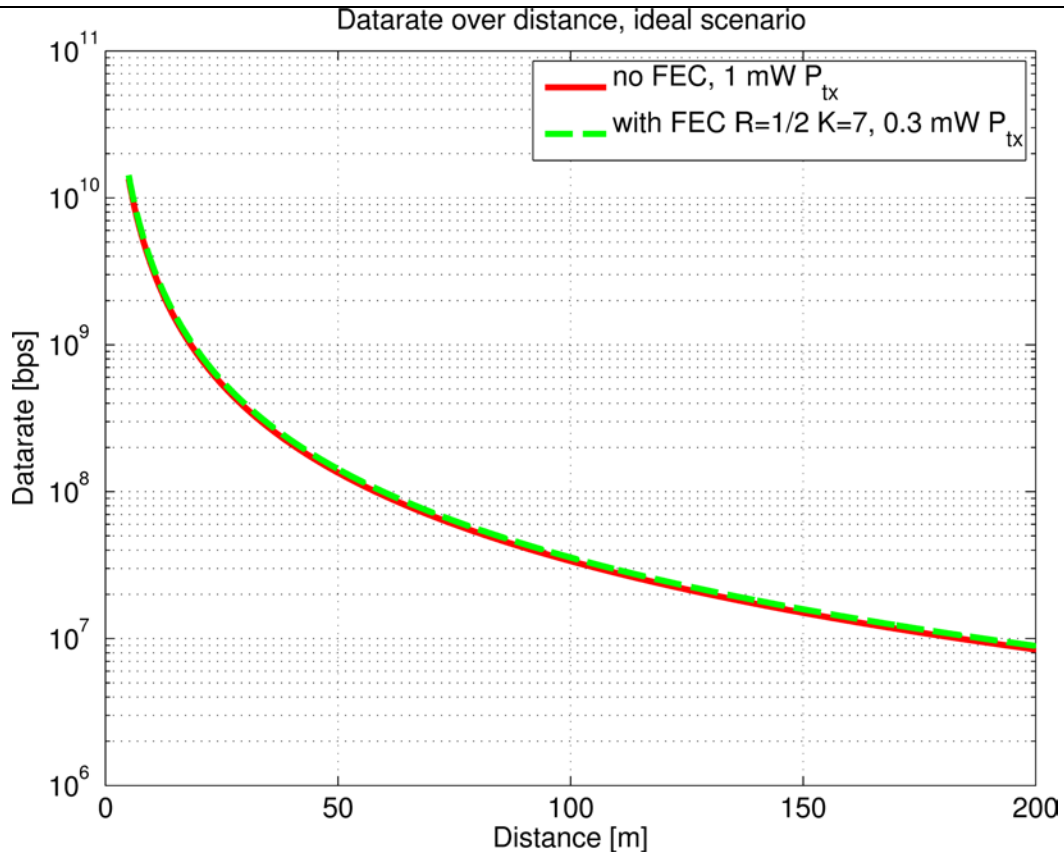

Figure 12: Decrease in transmit power for FEC R=1/2 K=7 coded transmission compared with uncoded transmission for the ideal scenario.

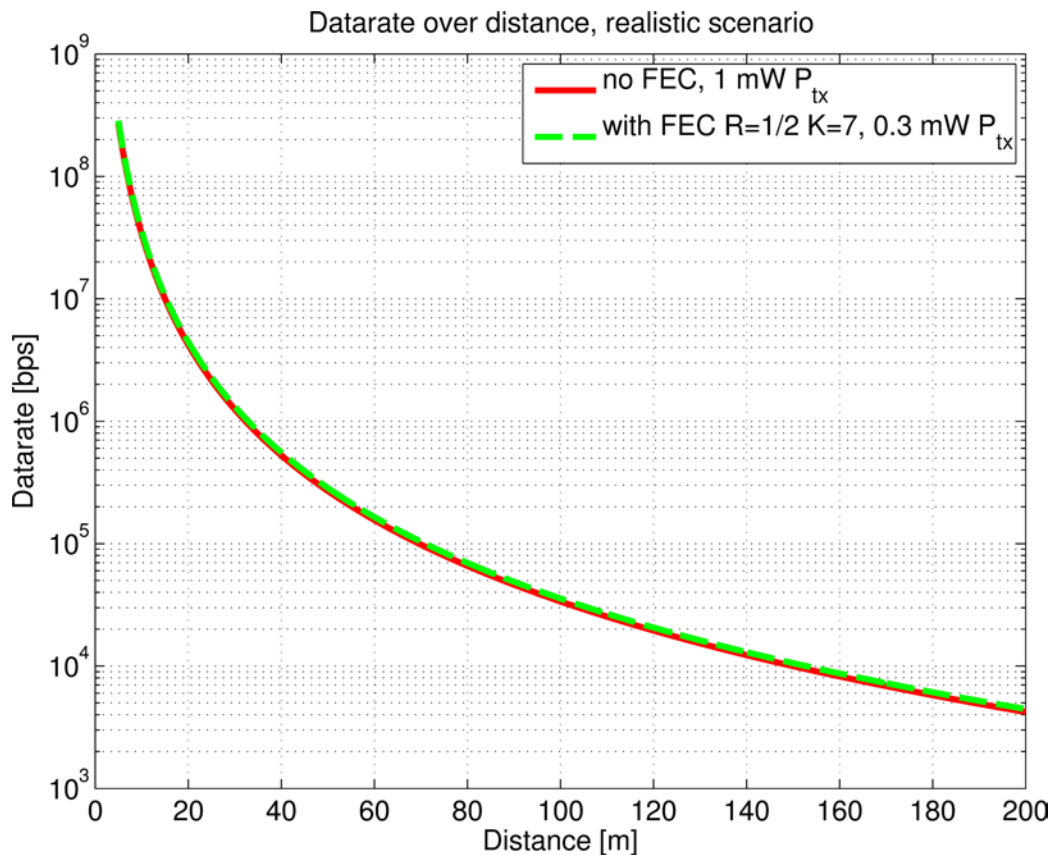

Figure 13: Decrease in transmit power for FEC R=1/2 K=7 coded transmission compared with uncoded transmission for the realistic scenario.

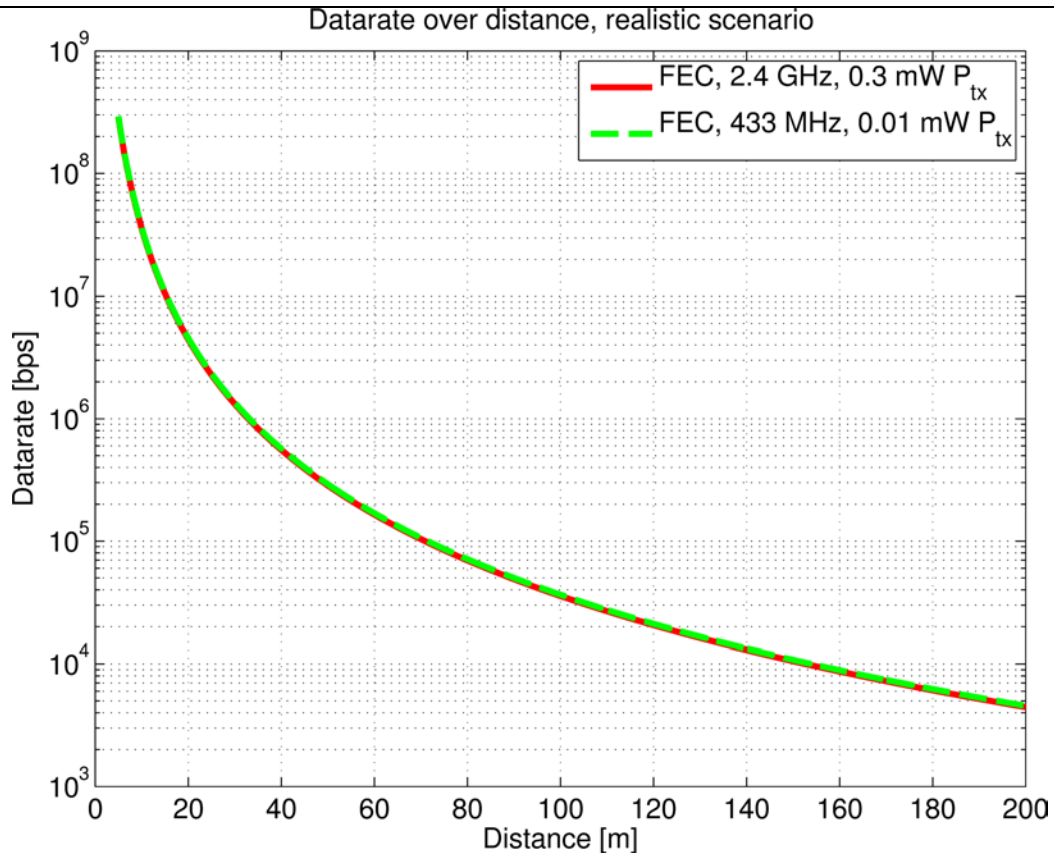

Figure 14: Comparison of necessary transmit power P_t for different frequency bands (FEC $R=1/2$ $K=7$)

Figure 14 shows how the frequency band affects the necessary transmit power for successful transmission. While at the 2.4 GHz band a transmit power of 0.3 mW is needed (when using the proposed FEC scheme), the necessary transmit power when using the 433 MHz band is only 0.01 mW.

4.5 Link Budget Calculations

Table 2 shows some link budget calculations for the ideal (i.e. LOS) case with two different datarates. In this scenario the FEC with $R=1/2$, $K=7$ is used (cf. section 4.2). As can be seen the link margin would allow for a much higher range and/or lower transmit power. The values for frequency, range, transmit power, antenna gains etc. have solely been chosen for comparison and are no system recommendation.

Table 2: Link budget calculations for ideal (i.e. LOS) case

	Low Datarate Mode	High Datarate Mode
Transmitter Parameters		
Payload Data Rate (D_B) in kBit/s	250	500
Distance (d) in m	30	30
Tx Antenna Gain (G_{TX}) in dB	0	0
Center Frequency (F_C) in MHz	2450	2450
Average Transmit Power (P_T) in dBm	-5	-5
Receiver Parameters		
Path loss at distance d in dB	69.77	69.77
Rx Antenna Gain (G_{RX}) in dB	0	0
Received Energy per Bit in dBm	-128.75	-131.75
System Noise Figure in dB	10	10
Minimum E_b/N_0 required in dB	3.2	3.2
Implementation Loss in dB	3	3
Link Margin in dB	29.05	26.05
Req. receiver Sensitivity in dBm	-107.02	-104.02

Table 3 shows an exemplary calculation for link budget when up- and downlink are asymmetric (cf. Figure 3). As can be seen the worse E_b/N_0 (caused by the usage of a non precoded modulation without any FEC, cf. section 4.2) in the downlink can be perfectly compensated by a higher transmit power from the concentrator.

Table 3: Link budget calculations for asymmetric up- and downlink (cf. Figure 3)

	Uplink	Downlink
Transmitter Parameters		
Payload Data Rate (D_B) in kBit/s	250	250
Distance (d) in m	30	30
Tx Antenna Gain (G_{TX}) in dB	-5	0
Center Frequency (F_C) in MHz	868	868
Average Transmit Power (P_T) in dBm	-10	+5
Receiver Parameters		
Path loss at distance d in dB	60.8	60.8
Rx Antenna Gain (G_{RX}) in dB	0	-5
Received Energy per Bit in dBm	-129.78	-114.78
System Noise Figure in dB	5	10
Minimum E_b/N_0 required in dB	3.2	11.9
Implementation Loss in dB	3	3
Link Margin in dB	33.02	34.32
Receiver Sensitivity in dBm	-108.82	-95.12

References

1. Jinesh P Nair, Kiran Bynam, Youngsoo Kim; "System Considerations for ULP Communications" IEEE P802.15 Working Group for Wireless Personal Area Networks (WPANs), DCN: 15-13-0426-00 , July 2013.
2. Frederik Beer and Jörg Robert, "Considerations for optimal data rates "IEEE P802.15 Working Group for Wireless Personal Area Networks (WPANs), DCN: 15-13-0322-00, May 2013.
3. Rappaport, T., "*Wireless Communications*" Second Edition, Upper Saddle River, NJ: Prentice Hall, 2002.
4. S. Dolinar, D. Divsalar, and F. Pollara. "*Code Performance as a Function of Block Size.*" TMO Progress Report 42-133 (January-March 1998)
5. John G. Proakis, "*Digital Communications*", 5th Edition, McGraw Hill, 2007