

Project: IEEE P802.15 Working Group for Wireless Personal Area Networks (WPANs)

Submission Title: [Review and Amendment of IEEE802.15.6 BAN to focus on Dependable Wireless BAN of Things]

Date Submitted: [20 March, 2013]

Source: [Ryuji Kohno] [1;Yokohama National University, 2;Centre for Wireless Communications(CWC), University of Oulu, 3;University of Oulu Research Institute Japan CWC-Nippon]

Address [1; 79-5 Tokiwadai, Hodogaya-ku, Yokohama, Japan 240-8501

2; Linnanmaa, P.O. Box 4500, FIN-90570 Oulu, Finland FI-90014

3; Yokohama Mitsui Bldg. 15F, 1-1-2 Takashima, Nishi-ku, Yokohama, Japan 220-0011]

Voice:[1; +81-45-339-4115, 2:+358-8-553-2849], FAX: [+81-45-338-1157],

Email:[kohno@ynu.ac.jp, ryuji.kohno@oulu.fi] **Re:** []

Abstract: [Body area networks(BAN) should be more dependable for major life critical applications such as medicine, disaster, dependable sensing and controlling cars, buildings, smart grids, and smart city by extending BAN from human body to bodies of cars, buildings, and so on. That is so-called BAN of things like Internet of Things. While keeping advantages of IEEE802.15.6, specifications of MAC and PHY may be revised to make it much more reliable, secure, fault tolerant, robust against undesired factors.]

Purpose: [The presentation will introduce current ongoing research and development on dependable wireless networks in order to promote a new working group or merge with others.]

Notice: This document has been prepared to assist the IEEE P802.15. It is offered as a basis for discussion and is not binding on the contributing individual(s) or organization(s). The material in this document is subject to change in form and content after further study. The contributor(s) reserve(s) the right to add, amend or withdraw material contained herein.

Release: The contributor acknowledges and accepts that this contribution becomes the property of IEEE and may be made publicly available by P802.15.

Review and Amendment of IEEE802.15.6 BAN to Focus on Dependable Wireless BAN of Things

Revision of IEEE802.15-12-0370-00-wng0

WNG Session Presentation

22nd March 2013 Orlando, Florida

Ryuji Kohno, Ph.D., IEEE & IEICE Fellows

*Professor, Yokohama National University, Japan

**Finnish Distinguished Professor, Centre for Wireless Communications (CWC), University of Oulu, Finland

***CEO, University of Oulu Research Institute Japan CWC-Nippon

Contents

1. Recall of My Presentation in WNG Session in July 2012
2. Review of IEEE802.15.6 for Wireless BAN
3. Background for Amendment of IEEE802.15.6
4. Dependability of Wireless Networks
5. First Focus on Amendment of 15,6 for Dependable Medical BAN and Extend to BAN of Things
6. Possible Amendment of BAN
7. What to be documented
8. Action Plan for TG6a(amendment of IEEE802.15.6)
9. Questions & comments

1. Recall of My Presentation in WNG Session in July 2012

- Doc. IEEE802.15-12-0370-00-wng0 : **Dependable Wireless M2M Network for Controlling - Applications for Cars, Energy, Medicine, Cities –**
- I proposed to start **either a new IG on Dependable M2M or a IEEE802.15 TG6 amendment of BAN** in July. I could get about 40 supporting votes for this action.
- **I asked Pat to postpone its opening** because I could not attend IR meeting in September due to my obligation for our government.
- **When I joined in Plenary in November**, I asked to open IG-DEP but could not come in January.
- **I started IG-DEP** at Tuesday Am1 session in this March, where I discussed with 12 attendees to **focus on amendment of TG15.6.**
- **To recall and promote this activity, I present this.**

2. IEEE802.15.6 Review

2.1 Definition of Body Area Network

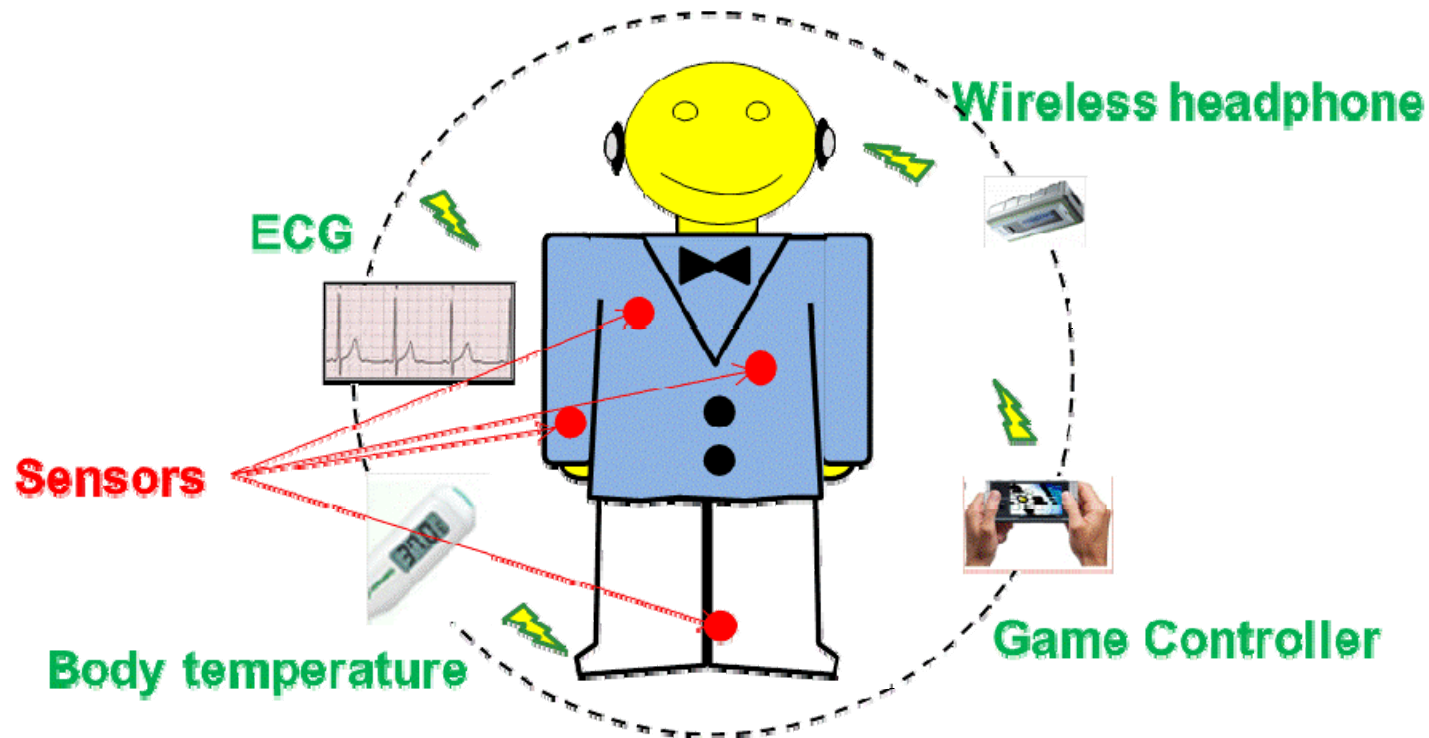

BAN provides short range, low power and highly reliable wireless communication for use in close proximity to or inside body. BAN should be compliant for FDA & FCC regulation for dependable services.

Wireless Network Standardization(IEEE802)

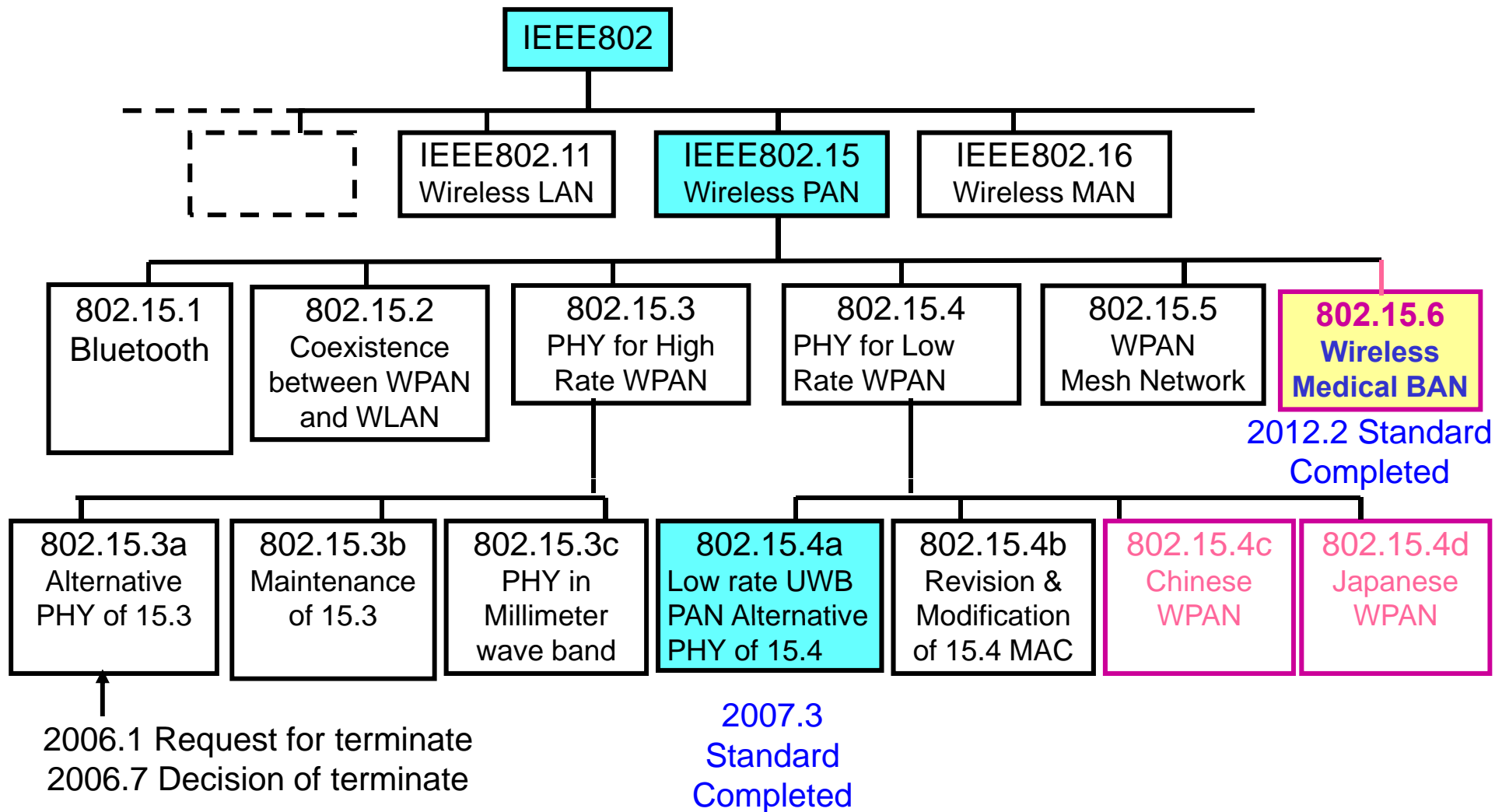

2.2 Main Contributors at TG6

- Casuh
- CEA-LETI
- CNU
- CSEM
- CUNY
- ETRI
- France Telecom
- Fujitsu Lab. Europe
- Fujitsu Lab.
- GE Global Research
- GE Healthcare
- IMEC
- Inha University
- KETI
- Korpa
- LG Electronics
- Meiji Univesity
- *Mitsubishi Electric Research Labs, USA*
- NICT
- NICTA
- NIST
- Olympus, USA
- Philips, USA
- Philips, EU
- Samsung
- Tensorcom
- Texas Instrument
- Thales
- Toumaz Technologies
- Yokohama National University
- Zarlink Semiconductor
-

Asia
Europe
USA

2.3 Top View of IEEE Std 802.15.6

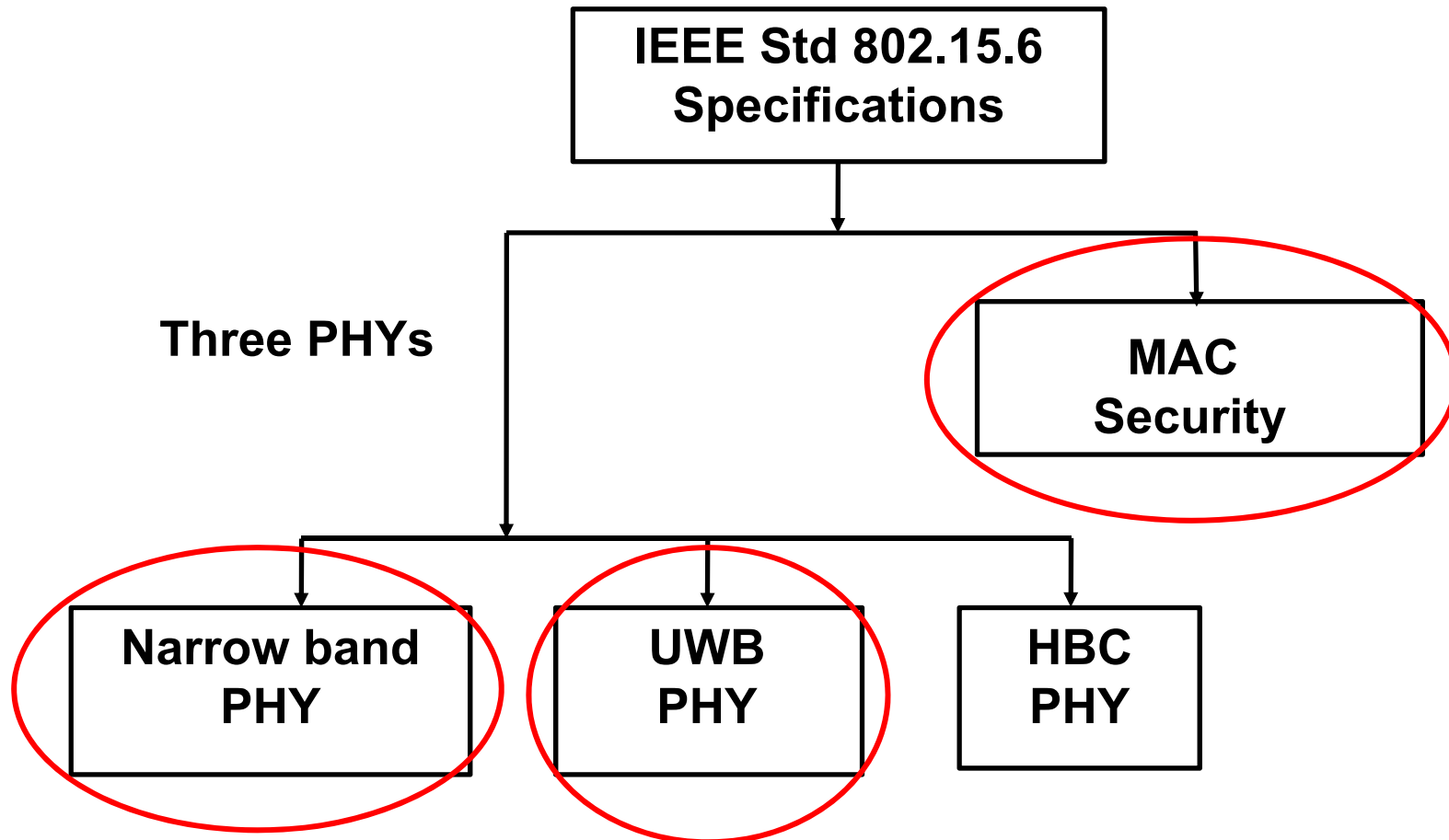

UWB: Ultra-wideband
HBC: Human body communication

2.4 IEEE802.15.6: PHY & MAC Solution for Wearable and Implanted BAN

- Covered differences between wearable and implant BAN links

	Wearable BAN links	Implant BAN links
Frequency band	ISM/UWB	400MHz-MICS
Channel model	multipath	path-loss
Safety	SAR and interference to other devices e.g. pacemaker	SAR, materials, and interference to other devices, e.g. pacemaker

- Possible approach; Two-PHY solution with the same MAC

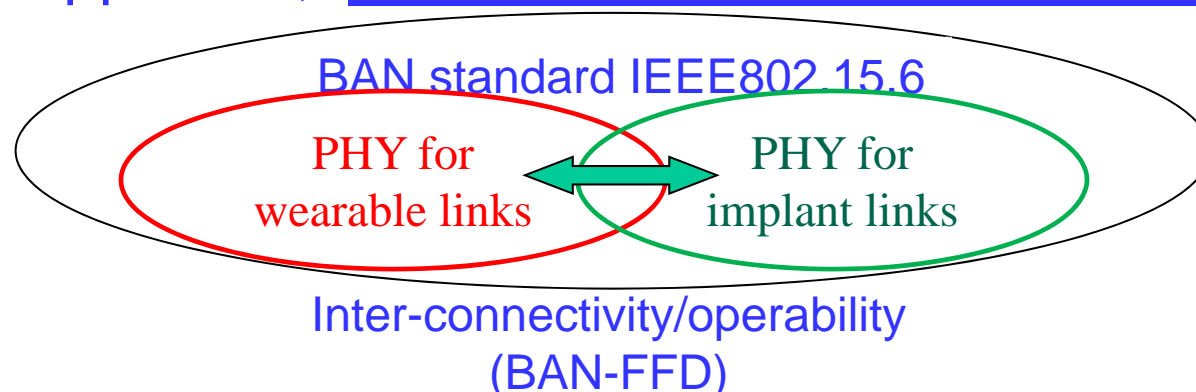

2.5 User Priority Mapping

Applications required guaranteed performance with dependability

Priority level	Traffic designation	Data type
7	Emergency or medical event report	Data
6	High priority medical data or network control	Data or management
5	Medical data or network control	Data or management
4	Voice	Data
3	Video	Data
2	Excellent effort	Data
1	Best effort	Data
0	Background	Data

2.6 Three Channel Access Modes

Wide variety of time structured and non structured modes in MAC

Channel access mode	Time reference-based (superframe structure)	Beacon	Notes
I	Yes	Yes	Coordinator sends beacon in each superframe except for inactive superframes.
II	Yes	No	Coordinator establishes time reference but doesn't send beacon.
III	No	No	There is not time reference.

Draft 06

2.7 Time-referenced Superframe w/ Beacon

Clock and position of each access phase

May obtain contended allocation for highest priority

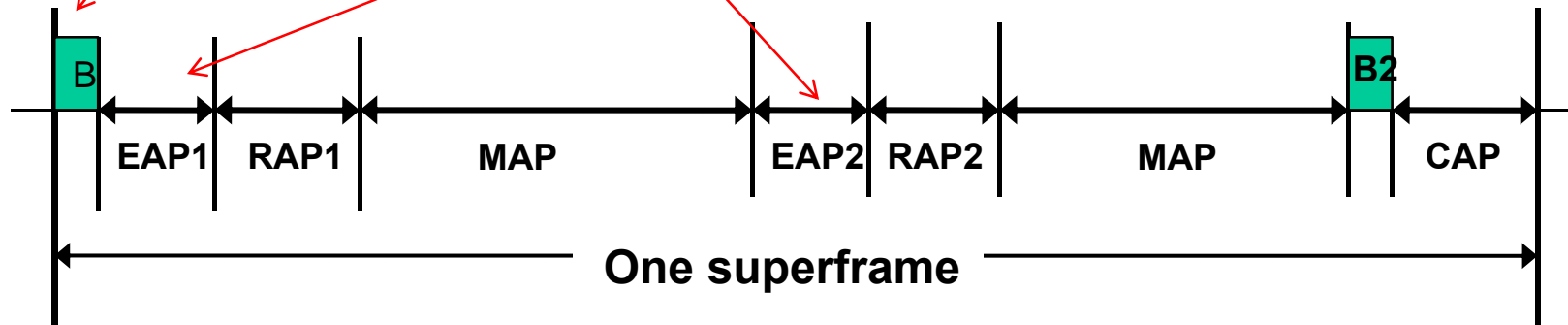

- EAP: exclusive access phase**
- RAP: random access phase**
- MAP: managed access phase**
- CAP: contention access phase**

2.8 Main Features of the Three PHYs

	Frequency band (MHz)	Data rate (kbps)	Note
NW-PHY	400, 600, 800, 900, 2400	75.9 --- 971.4	Interference with other systems operate at the same bands
UWB-PHY	6000-10600 3100-4800	390 --- 12600	Worldwide common band is 7.25 – 8.5 GHz
HBC-PHY	21	164 --- 1312.5	Strong concern on the effect to implant devices

2.9 Main Specifications of NB-PHY

Frequency bands (MHz)	Modulations		Data rates (kbps)	Number of channel	Notes
	PLCP header	PSDU			
402-405	$\pi/2$ -DBPSK	$\pi/2$ -DBPSK, $\pi/4$ -DQPSK $\pi/8$ -D8PSK	75.9/151.8/ 303.6/455.4	10	Majority of countries
420-450	GMSK	GMSK	75.9/151.8/187.5	12	Japan
863-870	$\pi/2$ -DBPSK	$\pi/2$ -DBPSK, $\pi/4$ -DQPSK $\pi/8$ -D8PSK	101.2/202.4/ 404.8/607.1	14	EU
902-928	$\pi/2$ -DBPSK	$\pi/2$ -DBPSK, $\pi/4$ -DQPSK $\pi/8$ -D8PSK	101.2/202.4/ 404.8/607.1	60	North America, Australia
950-958	$\pi/2$ -DBPSK	$\pi/2$ -DBPSK, $\pi/4$ -DQPSK $\pi/8$ -D8PSK	101.2/202.4/ 404.8/607.1	16	Japan
2360-2400	$\pi/2$ -DBPSK	$\pi/2$ -DBPSK, $\pi/4$ -DQPSK	121.4/242.9/ 485.7/971.4	39	USA
2400-2483.5	$\pi/2$ -DBPSK	$\pi/2$ -DBPSK, $\pi/4$ -DQPSK	121.4/242.9/ 485.7/971.4	79	Worldwide

2.10 Main Specifications of UWB-PHY

Mode	Modulation	Data rate (Mbps)	Waveform
IR-UWB (I)	OOK	0.49 – 15.6	Chirp pulse, chaotic pulse, SRRC-like pulse, or others.
IR-UWB (II)	DBPSK/DQPSK	0.49 – 15.6	
FM-UWB	Continuous-phase 2FSK (sub carrier) combined with FM	≤ 0.25	Gaussian (default)

- **FM-UWB is an optional mode**
- **Mutual Interference with other UWB nets**
- **High QoS mode**
 - **Hybrid Type II ARQ**

2.11 Main Specifications of HBC PHY

● HBC frequency band

- center frequency: **21MHz (3dB_BW=5.25MHz)**

● Transmission method

- **Frequency Selective Digital Transmission**

● Data rate

- **164, 328, 656, 1312.5 kbps**

Regulatory Compliance with Regional Regulations and impact in implanted devices like pace-makers

The electrode in contact with the body is used for transmitting or receiving an electrical signal through the body to a device

2.12 World Wide UWB Regulations

Need Feasible manners of DAA and LDC for Dependable Services

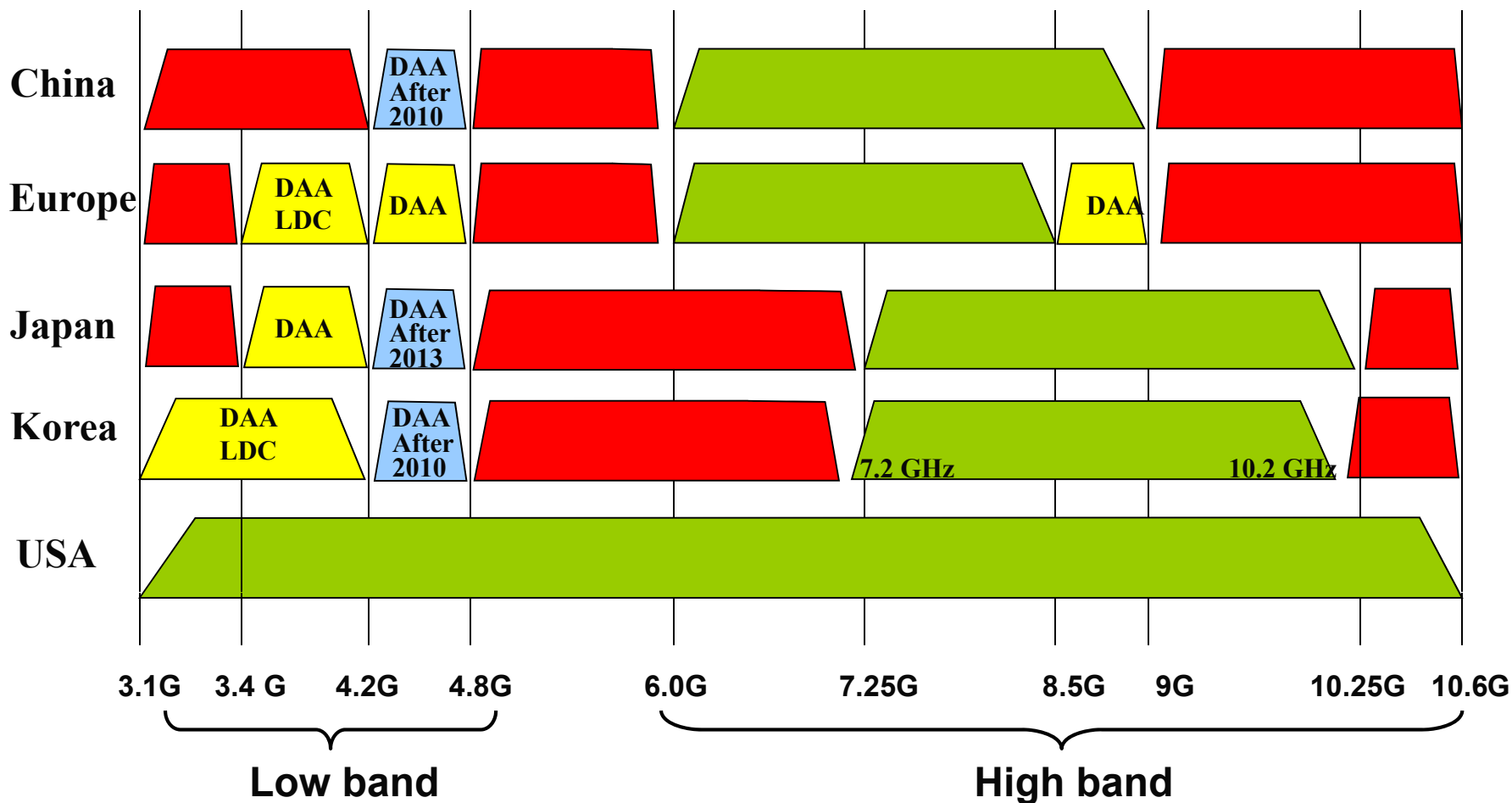

2.13 Specifications of High Band UWB

Interference Immunity with Other UWB Devices for Dependability

Items	Specifications
Frequency band	7.25 – 10.25 GHz
Average e.i.r.p.	≤ -41.3 dBm/MHz
Peak e.i.r.p.	≤ 0 dBm/50MHz
Average unwanted radiation	≤ -70 dBm/MHz
Peak unwanted radiation	≤ -64 dBm/MHz
Pulse rate	~ 50 Mpps
Communication range	~ 3 m

2.14 Prototype BAN Using UWB High Band

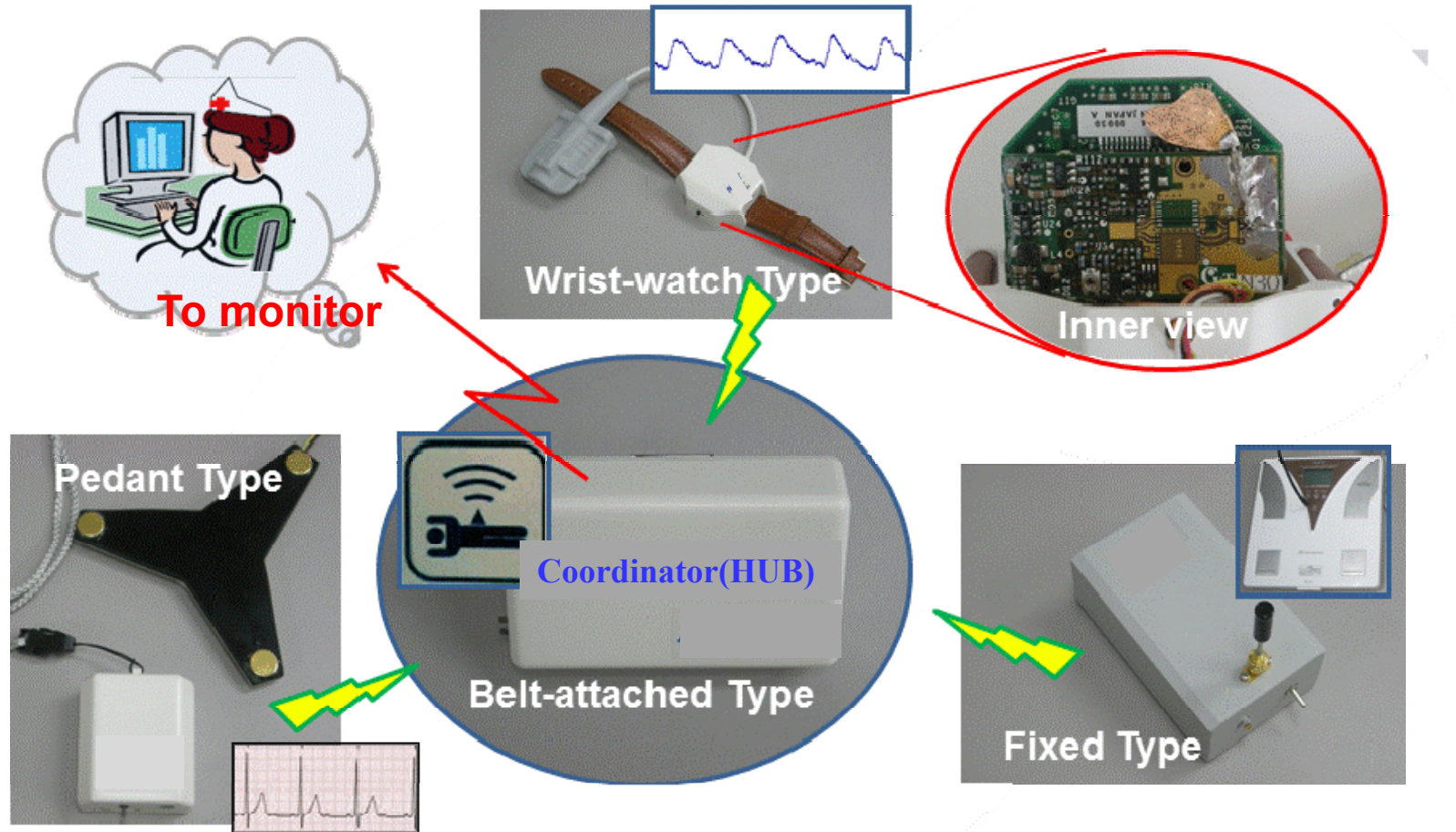

2.15 Prototype BAN Using UWB High Band

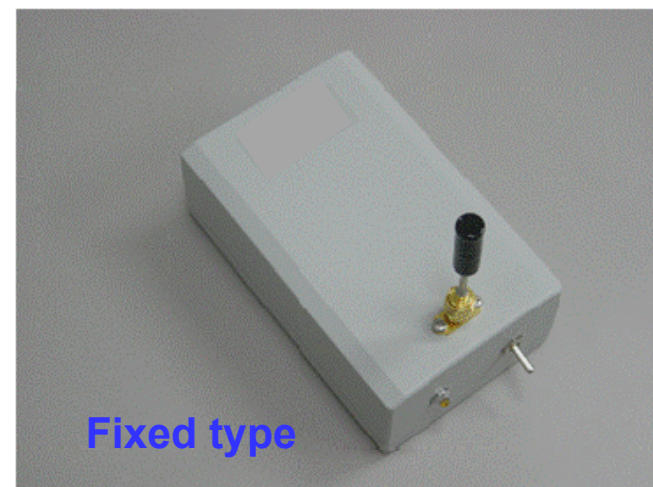
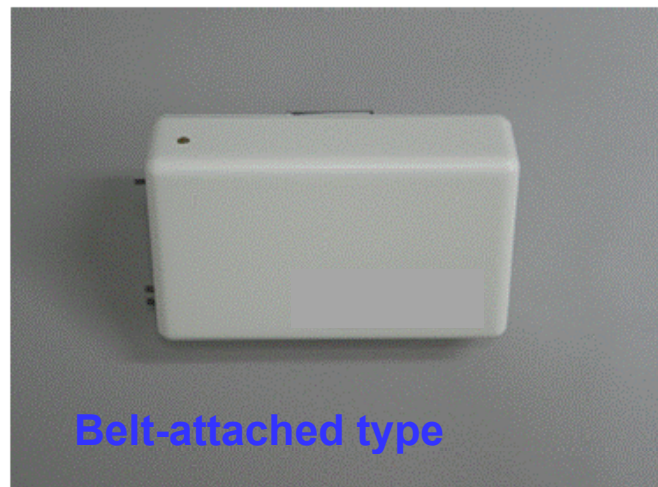
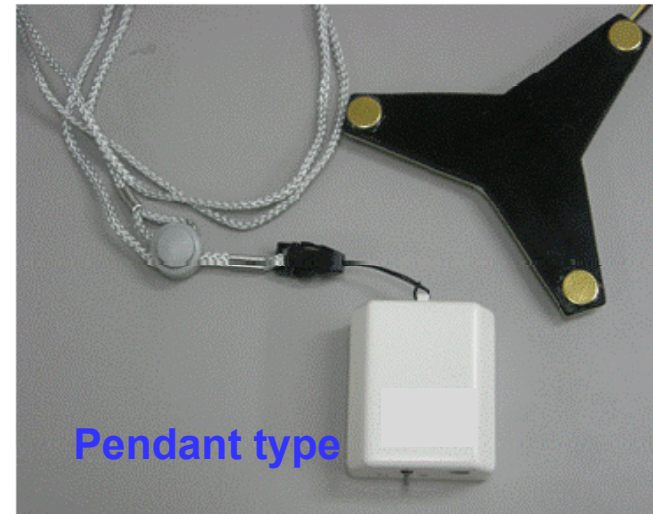

2.16 Peak Power of UWB Signal

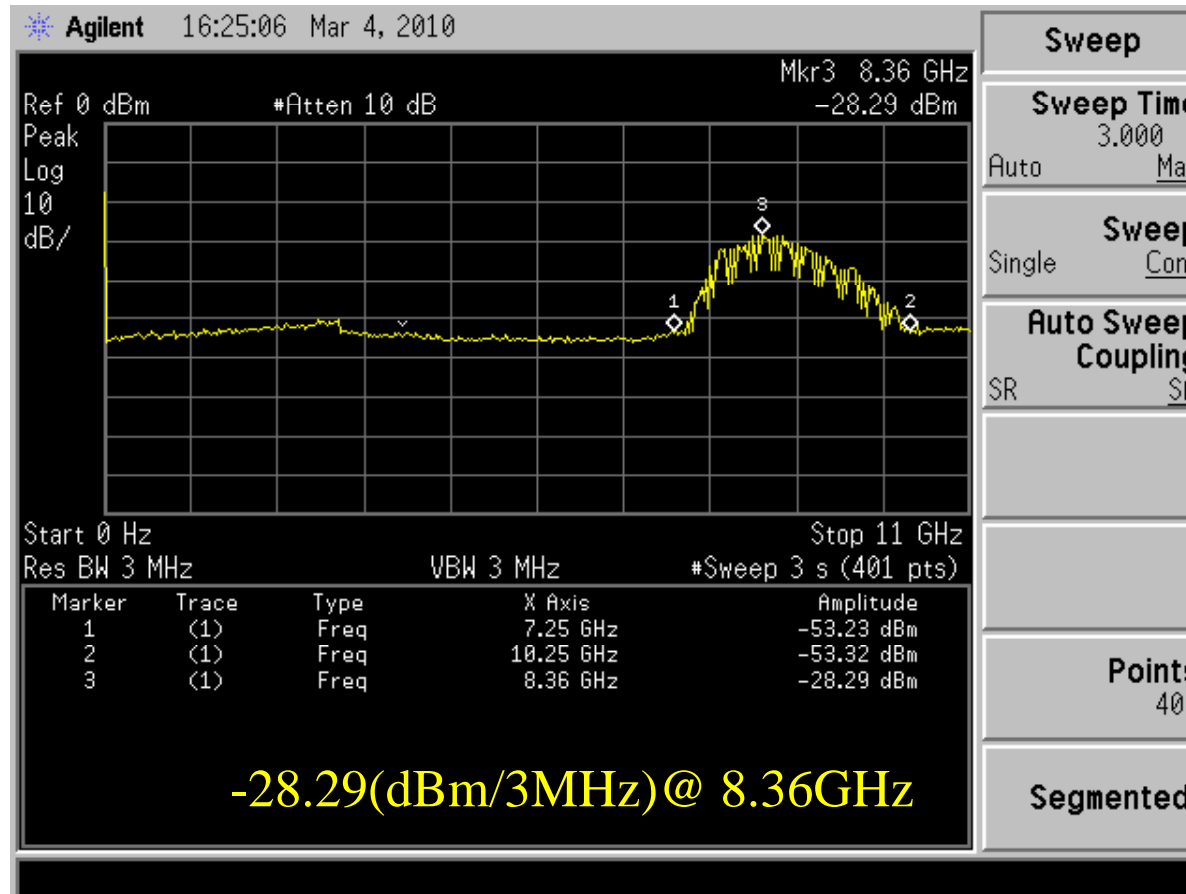

Calculation of Peak Power:

$$P_{\text{peak}} = -28.29\text{dBm}/3\text{MHz} + 20\log\left(\frac{50\text{MHz}}{3\text{MHz}}\right) = -3.86\text{dBm}/50\text{MHz}$$

2.17 Monitor of Various Data

The screenshot shows the 'UWB BSM Ver 0.00' software interface. It features several data monitoring panels:

- ECG:** A panel titled '心電' (Heart Rate) showing a cyan waveform. A callout box labeled 'ECG' points to this panel.
- Carotid Pulse:** A panel titled '脈波' (Pulse Wave) showing a cyan waveform. A callout box labeled 'Carotid Pulse' points to this panel.
- Weight:** A panel titled '体重' (Weight) showing a value of '0'. A callout box labeled 'Weight' points to this panel.
- Device status:** A panel titled 'センサー制御情報' (Sensor Control Information) with a table of sensor status. A callout box labeled 'Device status' points to this panel.
- Attitude:** A panel titled '姿勢' (Posture) showing a silhouette of a person. A callout box labeled 'Attitude' points to this panel.
- Three-dimensional Acceleration data:** A panel titled '3軸加速度' (3-axis Acceleration) showing X, Y, and Z axes. A callout box labeled 'Three-dimensional Acceleration data' points to this panel.

センサー	有無	動作	動作監視	電池
心電	■	■	■	■
脈波	■	■	■	■
体重	■	■	■	■
3軸加速度	■	■	■	■

2.18 Field Test of BAN for Hospital, Office and Home

- Patient's centralized care in hospital
- Health check in office/home
- ECG checkup at daily load
- Demonstration of technologies for keeping remote transmission of vital data without becoming interrupted even if it moves between office/room while installing BAN system
- Even if vital data transmission is interrupted, we can confirm which link is disconnected.
- Own vital data (electrocardiograph (ECG), three axis acceleration, and outside body temperature) can be monitored at not only remote but also local place
- Remote monitoring by video and voice
- System construction to enable connection to data base with health care center etc. in the future by compatibility with TCP/IP network
- Rough location of BAN holder can be grasped

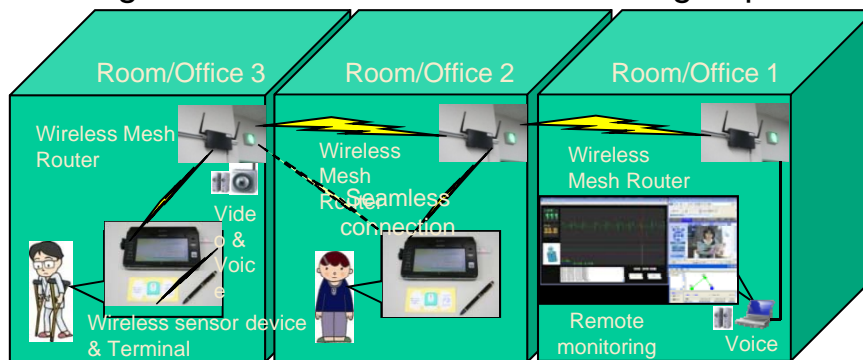

Submission

An Experiment in Hospital



Medical School, Yokohama City University

2.19 Summary of IEEE802.15.6 for BAN

Necessary Amendment for Dependable Service?

Coexistence?

Power consumption?

Outage probability?

Complexity?

Security?

Reliability?

IEEE 802.15.6

Narrow band PHY
on-body & in-body

UWB PHY
on-body

HBC PHY
on-body

Common MAC
(for all PHY)

- Modulation: **GMSK** & **DPSK**
- TX range: ~3m
- Bands: **MICS,WMTS,ISM**
- Data rate: ~ some Mbps

- Modulation: **IR-UWB** & **FM-UWB**
- TX range: ~3m
- Band: **UWB band**
- Data rate: ~10Mbps

- Frequency Selective
- 10-50MHz
- 125kbps-2Mbps

- **Beacon-base-TDMA**
- **Group Superframe**
- **Priority support**
- **Non-beacon mode**

2.19 Summary of IEEE802.15.6 Review

- **Body area network (BAN)** is considered as an important technology in supporting automatic **medical monitoring and healthcare maintenance** services as well as consumer centric electronics.
- A standard, **IEEE Std 802.15.6TM** was completed in Feb. 2012. Prototype BANs have been developed. **Compliant devices for 15.6 are already available but more dependability is requested for regulatory compliance for FDA and FCC.**
- However, there are several requests to revise IEEE802.15.6 as following typical requests and more,
 1. **The whole set of MAC specifications are too large to be implemented** in a simple device.
 2. **More robustness and security** against interference and jamming, and **minimum delay** for emergency use should **be guaranteed.**

3. Background for the Amendment

- Background:
 - We have completed standardization of WBAN: IEEE802.15.6 in February 2012, but its amendment may be needed for applications requesting more dependability such as emergency in medicine, disasters and so on.
 - **Dependability** of wireless ad-hoc networks must be more important to guarantee required minimum performance in machine-to-machine(M2M) remote sensing and controlling for medicine, disaster, cars, FA, and bldgs. than opportunistic ones for entertainments and CE.
- Aim:
 - We tried to open an independent IG on **Wireless Dependable M2M Network** at plenary session of July 2012.
 - **An amendment of IEEE802.15.6 must be more realistic while keeping advantages of the BAN standard as IEEE802.15.6a.**

3.1 Future Vision of Safe and Secure Social Infrastructures by Dependable ICT

Major Infrastructures using ICT have almost done and should be extended to Dependable Networks for Disaster Prevention, Green Innovation, Public Safety. (Examples of Dependable Wireless)

- A. Information Traffic (Telecommunications) → **Medicine ICT (Ubiquitous Medicine)**
- B. Vehicular Traffic (Transportation) → **Disaster ICT (Emergency and Rescue)**
- C. Energy Traffic (Power & Energy Supply) → **Environment ICT (Green Innovation)**
- D. Money Traffic (Commerce) → **Defense ICT (National Security)**
- E. Patient, Drug Traffic (Medicine)

To Dependable Wireless

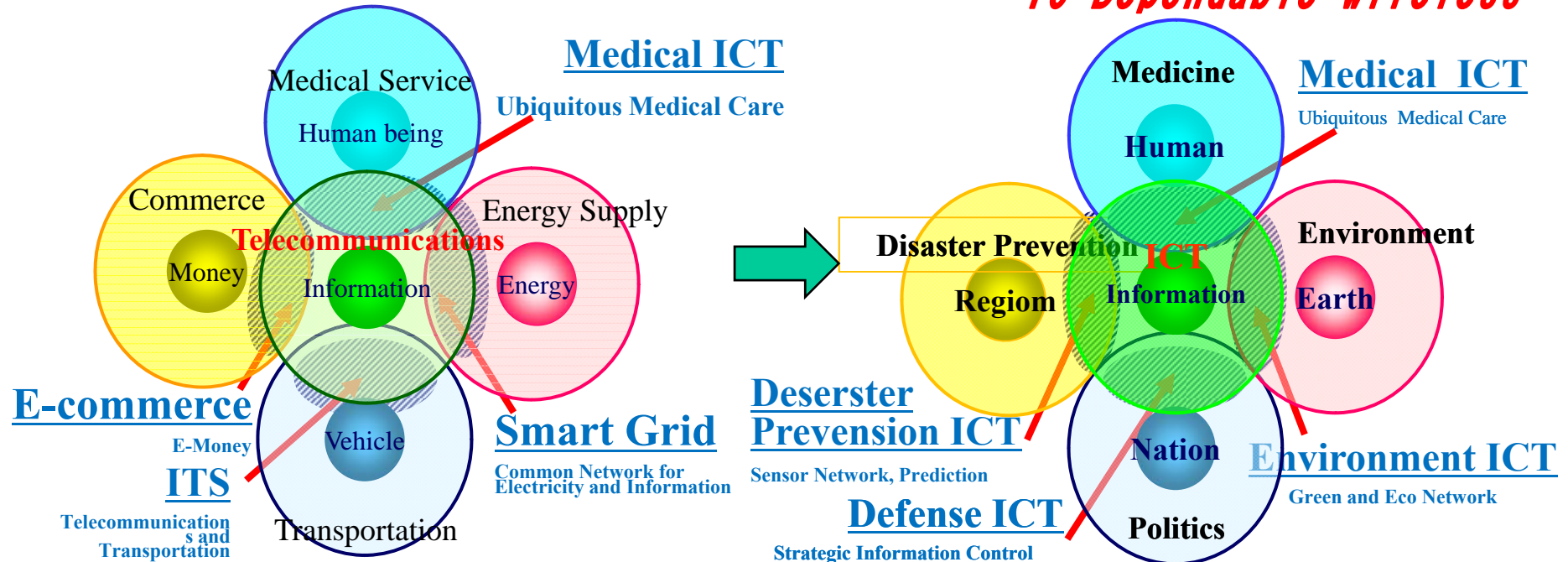

3.2 Future Vision of ICT

Prospective Core ICT Field

ICT for Safe and Secure QoL : **” Dependable ICT”**

- (1) ICT must guarantee highly safe, reliable and secure Quality of Life (QoL) by intelligent traffic controlling Finance, Transportation, Energy Supply, and Medical Healthcare , i.e. **e-Commerce, ITS, Smart Grid, and Medical ICT**
- (2) ICT should be dependable to support **green environment, national defense, disaster prevention, medical healthcare.**

Specific Core Disciplines

- (1) **Medical ICT** : can solve such social problems as lack of medical treatment budget, surgery errors by applying advanced ICT. Ubiquitous medicine can be performed by connecting BAN with infra networks, e.g. internet, cellular network, NGN.
- (2) **Environment ICT**: can control energy network and reduce pollution for ecology by using sensor networks to promote **Green Innovation.**
- (3) **Defense ICT**: can contribute protect a nation using satellite networks and remote sensing.
- (4) **Disaster ICT**: can predict and prevent disaster by sensor network and remote sensing and controlling.

4. Dependability in Wireless Networks

- **Meanings of Dependability:**
 - In Wikipedia, “**Dependability**” is a value showing the reliability of a person to others because of his/her integrity, truthfulness, and trustfulness, traits that can encourage someone to depend on him/her. The wider use of this noun is in Systems engineering.
 - For us, “**Dependability in network**” means to guarantee lowest performance enough high in a sense of highly reliable, safe, secure, fault tolerant, robust services in any predictable and even unpredictable worse environments.
- **Demand for Dependable Networks:**
 - Need for **Highly Reliable, Robust Communications for Controlling**
 - Transition from Human centric communications to **Machine-to-Machine (M2M) communications**.
 - Highly reliable, safe, secure and robust communications for **M2M Controlling** is necessary.
 - **Integrated wired & wireless networks** provide dependable, green and ecological networks adaptable for environment.

4.1 Internet of Things Vision

Machine/Device Centric Link Network

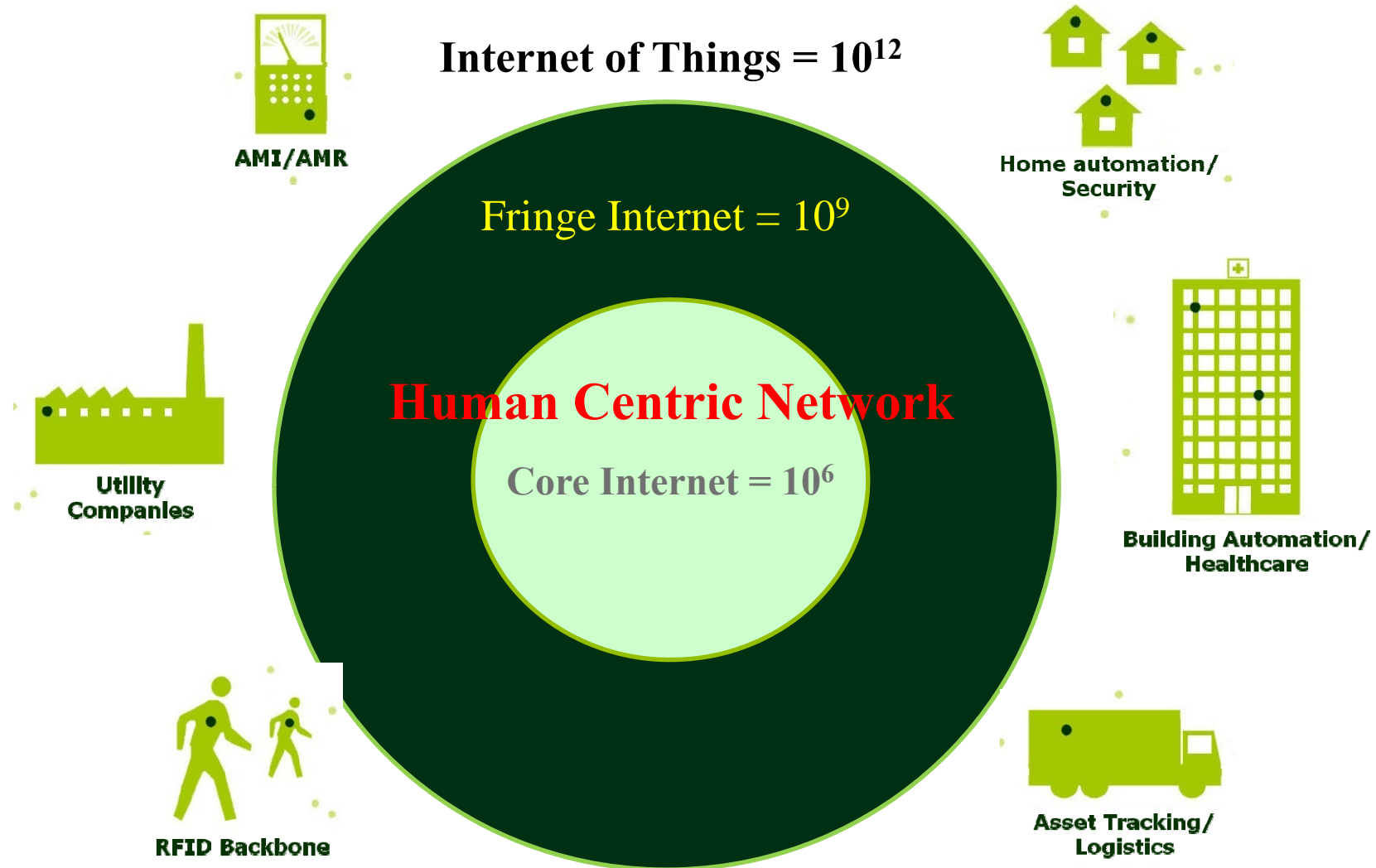

4.1 IoT for Global System Platform with clear business roles

Key Components

- Resource Directory
- Entity Directory
- Semantic Query Resolver
- WS&AN gateways
- Resource End Points
- Heterogeneous resources (6lowPAN, ZigBee, IEEE802.15.4 based WS&AN islands)
- **Security mechanisms** to enable controlled access to components

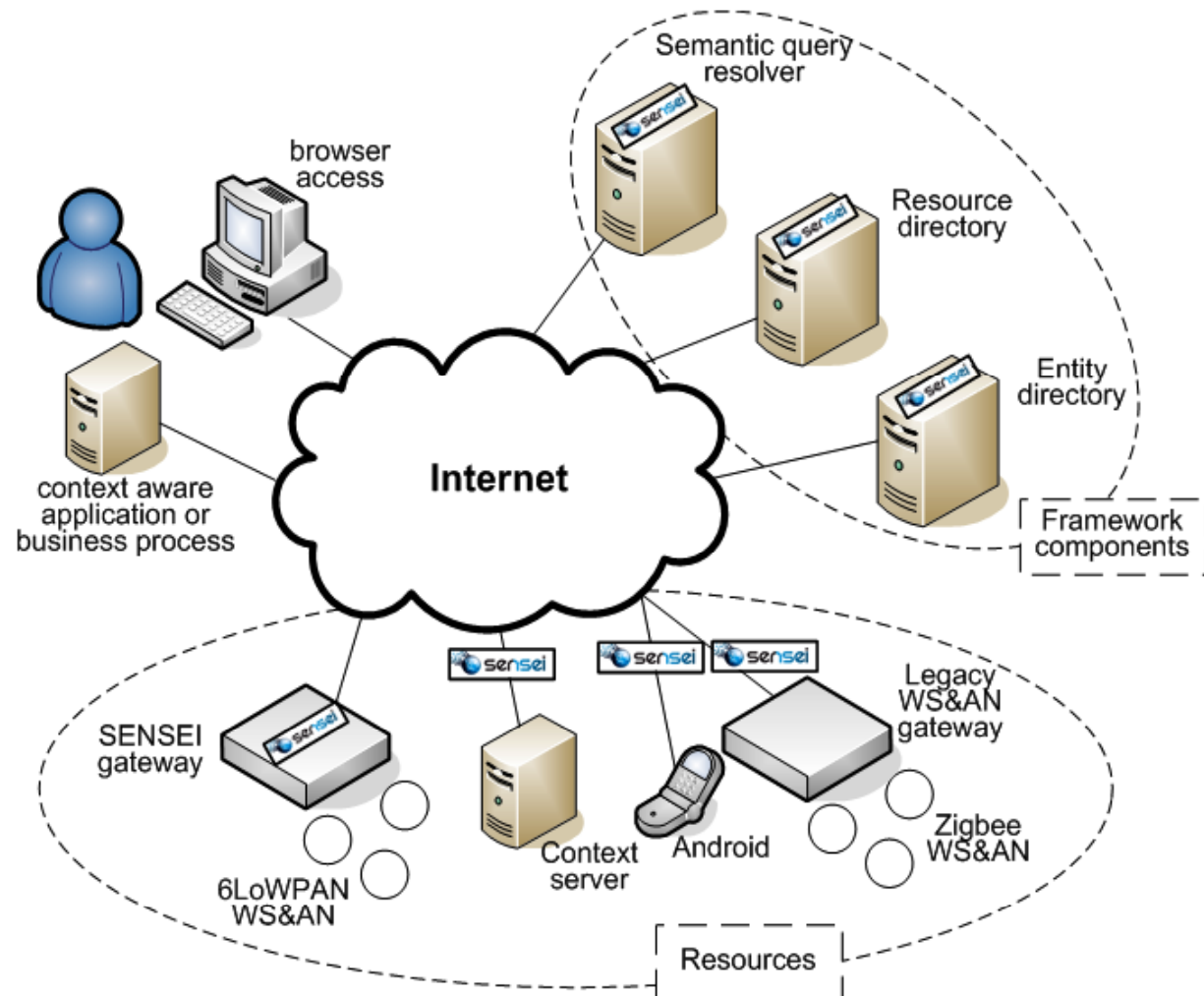

4.2 Internet of Things(IoT) versus BAN

- Current **IoT** mainly assumes **sensing and data acquisition** but **IoT** will be applied to **remote controlling** like M2M controlling.
- Current **IoT** acquires information in a stochastic manner through massive distributed resources in cloud, that **is not guaranteed and too opportunistic**.

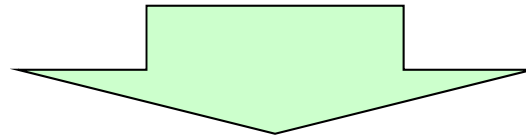

- **Body Area Network(BAN)** assumes both **remote sensing and controlling**.
- BAN must be **reliable, safe, resilient, i.e. dependable** because it is applied to **medicine**.

4.3 Dependability in Wireless BAN of Things for Sensing and Controlling

- **Demand for Dependability and Sustainability**
 - **Medicine, Robot, ITS, Energy Supply, and Manufacturing** require more dependability **in controlling network, integrated circuit, link in micro devices.**
 - Medical equipments and industrial products need **long life time, fault tolerance.**
 - **Dependable Network Architecture** for **M2M controlling.**
- **Guarantee Performance in Any Case**
 - **Lowest performance should be guaranteed enough high in a sense of highly reliable, safe, secure, fault tolerant, robust services in any predictable and even unpredictable worse environments.**

5. First Focus on Amendment of 15,6 for Dependable Medical BAN and Extend to BAN of Things

- First, we should **focus on amendment of 15.6** for high QoS BAN with new criteria and definition of dependability because medical use of BAN should be compliant for FDA regulation and safety guideline.
- Next, we can apply **BAN for human body into car & building bodies for dependable sensing and controlling** with the same high level of dependability as medicine for wider market.
- Timely applications are **emergency rescue in disaster and public safety** like 911 and 311 dependable ad-hoc network **for rescue, triage and recovering.**
- More applications are **Machine-to-Machine(M2M) links for feedback controlling** in factory automation, smart grid and more.

5.1 Medical Application of Dependable BAN

Wearable BAN

Tele-metering or sensing vital signs with various sensors

- ECG
- EEG
- Blood Pressure
- Heart Beat
- Body temperature
- Sugar rate
- Medical images
- And video
- Etc.

Pace Maker with ICD

Implant BAN

Tele-control of Medical Equipment and Devices

Capsule Endoscope

Novel Concept
Intelligent Network of Vital Sensors,
eHR, Medical Robots etc.

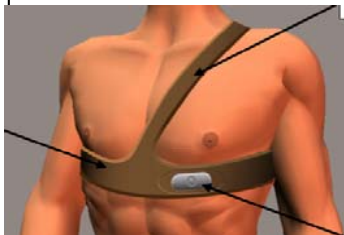

Submission



5.2 Dependable BAN of Things for Disasters

- **Dependable M2M like BAN or its extension** may be applicable for emergency rescue in disaster such as earthquake, fire, tsunami ...
- **On site of Disaster**
 1. **Warning** for each person against Tsunami and earthquakes
 2. **Navigating** each person to safer places or shelters
 3. **Rescuing** persons in dangerous situation with triage
- **After Disaster**
 1. **Identifying** each survivor alive or not, and health condition
 2. **Finding** each missing person using geo-location
 3. **Monitoring** environment as well as health condition
 4. **Remote medical maintenance and health care.**
 5. **Recovering** life lines and social infrastructure

5.3 Demands for Highly Dependable BAN of Things, M2M for Sensing and Controlling

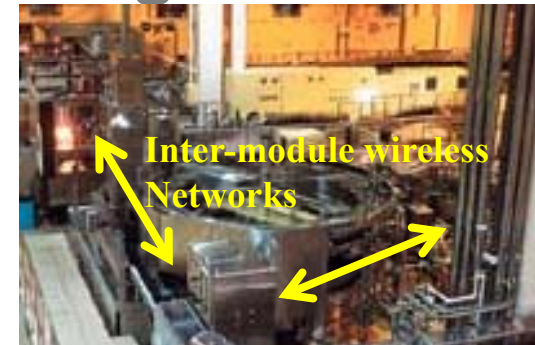
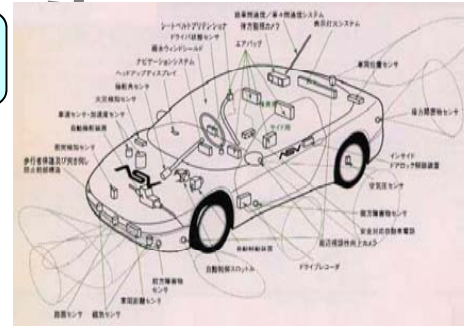
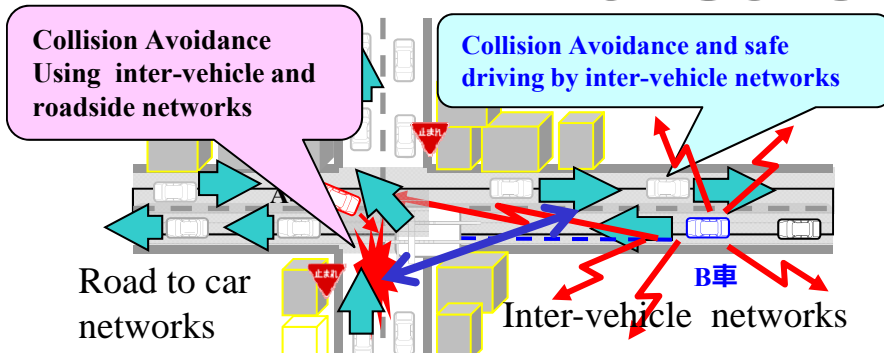

Car Navigation & Collision Avoidance Radar

Car LAN & Wireless Harness

Factory Automation (FA)

Dependable Wireless Networks for Transportation

Dependable Wireless Sensing & Controlling for Manufacturing (CIM)

Wearable BAN

Implant BAN

EEG,
ECG,
Blad Pressure
Temperatute
MRI images
Etc.

Pacemaker with IAD

UWB can solve such a problem that radio interferes a human body and medical equipments

Dependable Network among vital sensors, actuators, robots

Capsule Endoscope

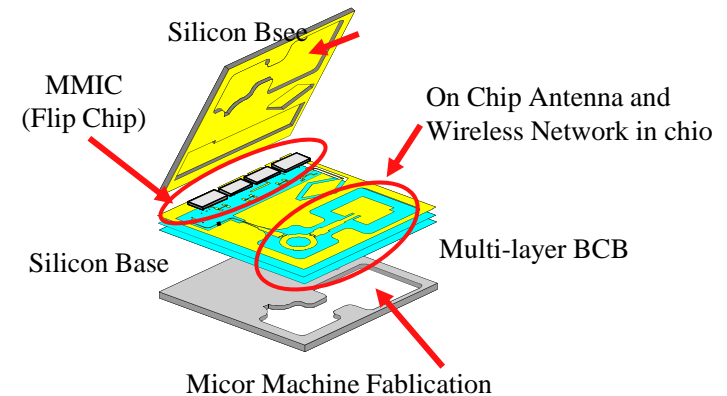

Dependable Wireless System Clock in Micro Circuit & Network in Devices

Dependable BAN for Medical Healthcare

5.4 Requirements for this Action

- Network Requirements for Dependable BAN of Things and M2M
 - **Definition** of dependability with scientific criteria and numerical necessary values as well as **design policy**.
 - **Classification of applications**; application matrix
 - **Mandatory technical requirements in PHY and MAC** to satisfy the dependability criteria and values
 - **Optional technical requirements in upper layer** such as fault tolerant routing, network coding, authentication and encryption.
 - Self organizing (forming /reforming network within minutes)
 - Feasibility study (bandwidth and power efficiency)
 - ~~Compliance testing body~~

6. Possible Amendment of BAN

Challenges for More Dependable Wireless BAN

- **Harmonisation of relevant standards towards the aggregation of wireless BAN**
 - BAN (e.g. Health, Medical and Commercial)
 - non-BAN (e.g. RFID, WLAN)
- **Multi-layer technical and standardisation issues:**
 - Interoperability of devices
 - **Coexistence between systems** (e.g. PHY-MAC, traffic priority, BAN and non-BAN systems)
 - Multi-radio, cross-band operation (more efficient, **more robust**)
 - Control/interaction with upper layers (e.g. middleware, PNs, application)
 - Providing the **necessary security and privacy**

6.1 PHY Technologies for Dependable BAN of Things

1. Spread Spectrum (CDMA, Radar)
2. Adaptive Array Antenna(Smart Antenna, MIMO, Space-Time Coding, Collaborating Beamforming)
3. **Diversity** (Space, Time, and Frequency Domains)
4. **Multi-band, Multi-Carrier(OFDM), Multi-Code**
5. **Coding** (Turbo Coding and Decoding, LDPC, Space-Time Coding, **Network Coding**)
6. Software Reconfigurable Radio (**SDR**: Software Defined Radio), E2R (End-to-End Reconfigurability),
7. Cognitive Radio & Network
8. Ultra WideBand (UWB) Radio
9. Collaborative Communications and Sensing

6.3 Communication Technologies in each Layer for Dependable BAN of Things

Application layer	Control algorithm
Network (NWK) layer	Scheduling (packet order control) Routing (route control)
Medium access control (MAC) layer	Time slot control (TDMA) Frequency control (FDMA) Contention window control (CSMA)
Physical (PHY) layer	Transmit power control Modulation level control Coding rate control

6.4 Cross Layer & Multi-Layer Optimization for Dependable BAN of Things

Dependable Wireless with Less Power Consumption & Robustness

Application Layer : Information Security(Encryption and Authentication, User Friendly Interface . . .

Network Layer : Integrated Wired & Wireless Network Architecture, Network Security(IP SEC) . . .

Data Link & MAC Layer : Priority Access Control, Fault Tolerant Routing, ARQ, Hybrid ARQ, Distributed Resource Management, . . .

Physical Layer : Cognitive, Reconfigurable, Adaptive, Robust Radio, Error-Controlling Coding, Space-Time Diversity, Equalization, Coded Modulation, . . .

Device/ Electronics Layer: Tamper Free Hardware, Robust Packaging, SoC, SOP, On-chip CODEC for channel Coding and Encryption . .

Joint Optimization of Multi Layers

6.5 Higher Layers Technologies for Dependable BAN of Things

1. Contention Free Protocol in MAC (TDMA, Polling, Hybrid CFP & CAP etc)
2. ARQ and Hybrid ARQ in Data Link (Type I, II)
combination of transmission and storage(buffering)
3. Parallel Routing (Risk Diversity) and Network Coding
in network architecture
4. Fault Tolerant Network (Redundant Link and Parallel Hopping) and Cognitive Networking
5. Encryption and Authentication in Application Layer
(AES, Camellia, Secret Sharing)

7. What to be documented

- Extend IEEE802.15.6 or make another specification?
 - Focus on **high QoS applications** like medicine, disaster, car controlling and life critical cases.
 - **Time to market** should be short while maintaining states of art in IEEE802.15.6.
- **Amendment of IEEE802.15.6** must be best choice.
- What to be included in the document?
 - **Simple and secure MAC protocol** with routing and error-controlling protocols in network and data link layers
 - Amendment of MAC and PHY considering joint optimization among **cross and multiple layers technologies** including network architecture, authentication and encryption for **dependability**.

8. Action Plan for TG6a (amendment of IEEE802.15.6)

- March 20,2013 Presentation in WNG session
- April, **5C and PAR** complete
- May, the issues will be socialized in DC
- June, approved at EC, 30 days before July meeting
- July, **TG6a(Amendment of IEEE802.15.6) start**
- Sept.-Nov., **Technical requirements**
- Jan.-March , 2014, **Call for Proposals**
- May-July, 2014, Down Selection
- Sept.-Nov., 2014, **Letter Ballots**
- Jan.-March, 2015, **Sponsor Ballots, EC approval.**

9. Questions & comments

- Move IG-Dependable M2M into TG-802.15.6 amendment such as 15.6a.
- Enlarge Dependability of BAN while uniqueness different from other IGs, SGs and TGs
- How many companies and institutes have interest on this activity?
- If we have enough supporters, we would like to step forward to make amendment of IEEE802.15.6 shortly.
- Please contact: kohno@ynu.ac.jp