

Project: IEEE P802.15 Working Group for Wireless Personal Area Networks (WPANs)

Submission Title: What's next? Wireless Communication beyond 60 GHz (Tutorial IG THz)

Date Submitted: 15 July 2012

Source: Thomas Kürner (Editor) **Company:** TU Braunschweig, Institut für Nachrichtentechnik
Address: Schleinitzstr. 22, D-38092 Braunschweig, Germany

Voice: +495313912416 FAX: +495313915192, E-Mail: t.kuerner@tu-bs.de

Re: IEEE 802.15-10-0847-01-0thz_Tutorial

Abstract: This tutorial gives an overview on recent achievements in the emerging field of communication systems operating beyond 60 GHz targeting to deliver wireless 100 Gbps over short distances. Within IEEE 802.15 the THz Interest Group is looking for systems for carrier frequencies in the THz band which starts at 300 GHz. The tutorial will provide an overview on the state-of-the art in technology and demonstrators for these frequency bands. Applications, for which dedicated standards may be appropriate, will be presented focusing on usage models and technical expectations. Finally the regulatory situation after WRC 2012 is discussed.

Purpose: Tutorial on the activities and the status of the IEEE 802.15 IG THz presented to the IEEE 802 Plenary

Notice: This document has been prepared to assist the IEEE P802.15. It is offered as a basis for discussion and is not binding on the contributing individual(s) or organization(s). The material in this document is subject to change in form and content after further study. The contributor(s) reserve(s) the right to add, amend or withdraw material contained herein.

Release: The contributor acknowledges and accepts that this contribution becomes the property of IEEE and may be made publicly available by P802.15.

What's next? Wireless Communication beyond 60 GHz

Tutorial of IEEE 802.15 IG THz @ IEEE 802 Plenary

Contributors:

Thomas Kürner, TU Braunschweig (Germany), t.kuerner@tu-bs.de

Ingmar Kallfass, Fraunhofer IAF (Germany), Ingmar.Kallfass@iaf.fraunhofer.de

Katsuhiro Ajito, NTT Corp. (Japan), ajito.katsuhiro@lab.ntt.co.jp

Akifumi Kasamatsu, NICT (Japan), kasa@nict.go.jp

David Britz, AT&T Shannon Labs (USA), dbritz@research.att.com

Sebastian Priebe, TU Braunschweig (Germany), priebe@ifn.ing.tu-bs.de

Outline

- **Introduction - Thomas Kürner**
- Technology Overview - *Ingmar Kallfass*
- Application Kiosk Downloading - *Katsuhiro Ajito*
- Application WLAN - *Akifumi Kasamatsu*
- New Wireless Networks - The Revolution of Multi-Gigabit Street Level Nanocells – *David Britz*
- Towards a Coexistent Spectrum Usage Between Active and Passive THz Systems - *Sebastian Priebe*
- Summary and Next Steps for the IG THz - *Thomas Kürner*

Introduction

Prof. Dr. Thomas Kürner¹

¹ Terahertz Communications Lab,
Institut für Nachrichtentechnik, Technische Universität Braunschweig, Germany

Chair IEEE 802.15 IG THz

Evolution of Data Rates in Wireless

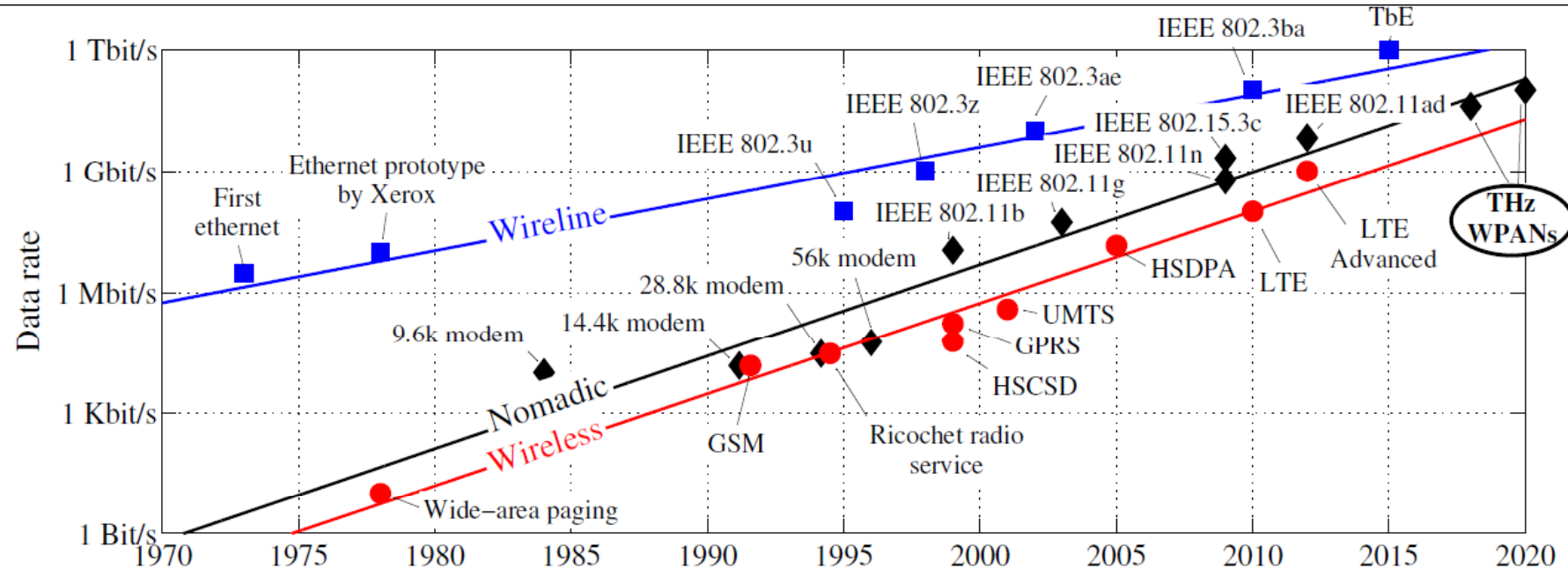

- 60 GHz Standards already completed or currently under development enable data rates of 6-7 Gbit/s
- Assuming the development observed in the past years extrapolate into the future we will see wireless 100 Gbit/s around the 2020

How much data can be transferred in one second?

Data rate	Size	Run time of 1080p24 video(*)
10 Gbps	1.25 GByte	4 min
40 Gbps	5.0 GByte	17 min
100 Gbps	12.5 Gbyte	42 min
1 Tbps	125 Gbyte	7 hours

(*)1080p24 video are hold on BlueRay-Discs and run at up to 40-Mbps rate
(source: <http://en.wikipedia.org/wiki/1080p24>)

What do we need x10 Gbit/s for?

- Aim: Ultra high data rates of 100 Gbit/s and beyond over rather short distances
- Potential scenarios:



(1) WPAN



(2) Kiosk downloads

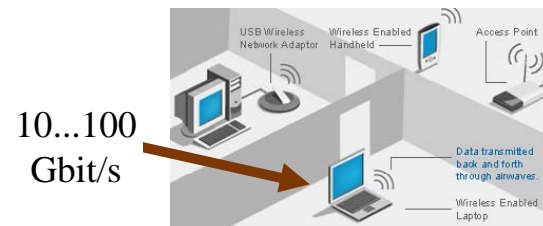

(3) WLAN

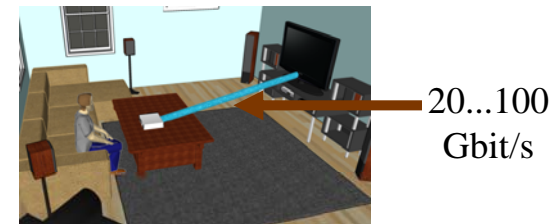

(4) Video streaming

→ But: Why using THz communications to achieve these data rates?

Why choosing THz frequencies?

- Spectrum allocations by the ITU below 300 GHz:



http://discovermagazine.com/2007/jun/tireless-wireless-allochrt_ig.jpg#issue

→ No free spectrum available below 300 GHz to achieve such high data rates with moderate spectral efficiencies

→ **No dedicated frequency allocation beyond 300 GHz (0.3 THz)**

Challenges to be addressed to make THz communication happen

- Propagation Channel beyond 300 GHz
 - To overcome the high path loss high-gain antennas in combination with beamforming/beamsteering are required
 - @100 Gbit/s only extremely low RMS delay spread in the order of a few ns can be tolerated
 - > High-gain antennas can also help to reduce the impact of multipath propagation
- Technology
 - In order to allow highly integrated transceivers technology with transit frequencies beyond 1 THz is required
 - Electro-optical or electronic generation of THz signals?
- Transmission and Networking
 - Appropriate solutions for PHY and MAC have to be defined.

THz @ IEEE 802.15: IG THz

- Already in 2008 IEEE 802.15 has established a THz Interest Group for Wireless Systems operating at 300 GHz and beyond
- Current Tasks of IEEE 802.15 THz Interest Group
 - Survey of technological developments
 - Channel modeling
 - Spectrum Issues (Interference studies THz Communications -> passive services)
 - Generating a Technical Expectations Document (TED)
 - Triggering the formation of one or more Study Groups to develop one or more standards
- Chair: Thomas Kürner (TU Braunschweig, Germany)
- Vice-Chair: David Britz (AT&T Shannon Labs, USA)
- Secretary: Katsuhiro Ajito (NTT Corp., Japan)
- Editor of TED: Rick Roberts (Intel, USA)

What this Tutorial is about...

- The tutorial will provide an overview on
 - recent achievements in the emerging field of communication systems operating beyond 60 GHz targeting to deliver wireless 100 Gbps over short distances.
 - the state-of-the art in technology and demonstrators for these frequency bands.
 - applications, for which dedicated standards may be appropriate, focusing on usage models and technical expectations.
 - the regulatory situation in the frequency range beyond 275 GHz after WRC 2012.

Outline

- Introduction - *Thomas Kürner*
- **Technology Overview - *Ingmar Kallfass***
- Application Kiosk Downloading - *Katsuhiro Ajito*
- Application WLAN - *Akifumi Kasamatsu*
- New Wireless Networks - The Revolution of Multi-Gigabit Street Level Nanocells – *David Britz*
- Towards a Coexistent Spectrum Usage Between Active and Passive THz Systems - *Sebastian Priebe*
- Summary and Next Steps for the IG THz - *Thomas Kürner*

Technology Overview

Prof. Dr. Ingmar Kallfass^{1,2}

¹ Fraunhofer IAF, Freiburg, Germany

² Karlsruher Institut für Technologie, Germany

Technologies for THz Comm

Required features

- Size and Weight
 - Multi-functional on-chip integration
- Ease of deployment
- Cost
- Performance
 - Tx power
 - Rx noise
 - LO stability

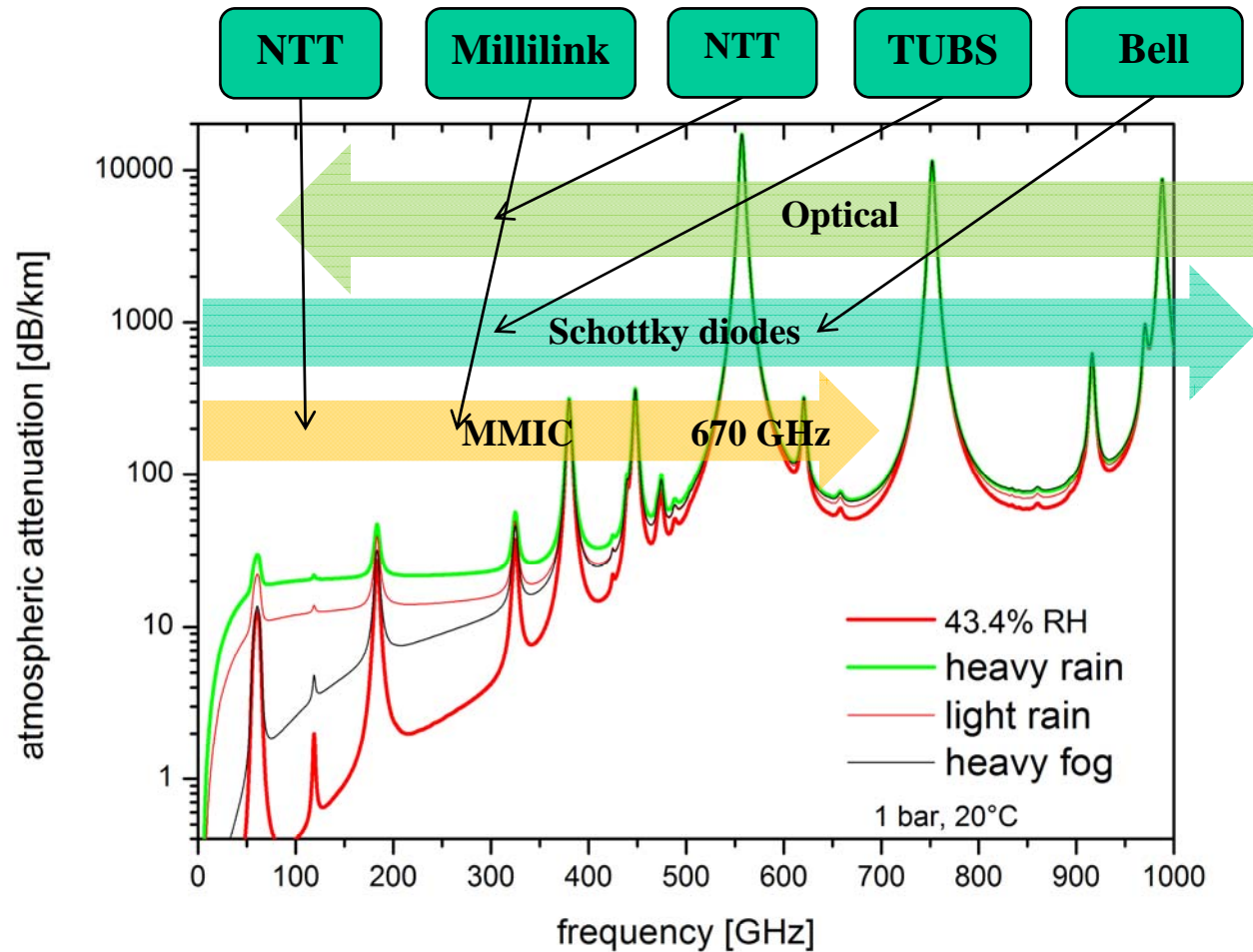

High Speed Transistor Technologies

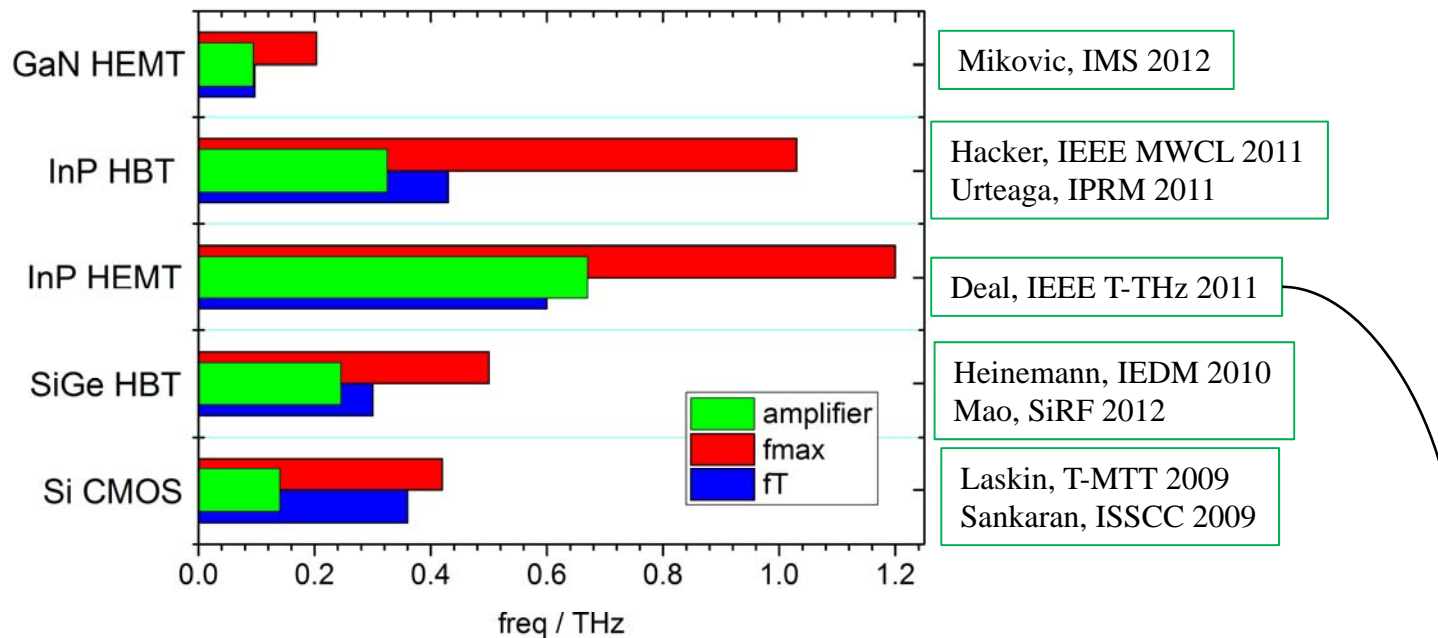

Mikovic, IMS 2012

Hacker, IEEE MWCL 2011
Urteaga, IPRM 2011

Deal, IEEE T-THz 2011

Heinemann, IEDM 2010
Mao, SiRF 2012

Laskin, T-MTT 2009
Sankaran, ISSCC 2009

NGC 30 nm InP HEMT

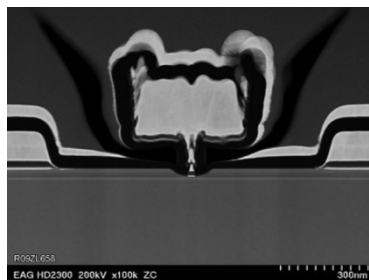

NGC 670 GHz LNA

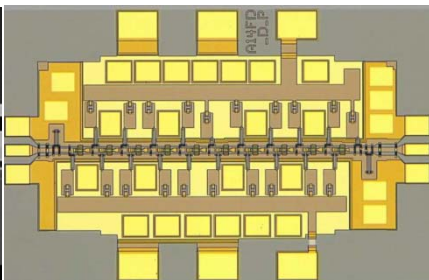

Transmit Power and Receiver Noise

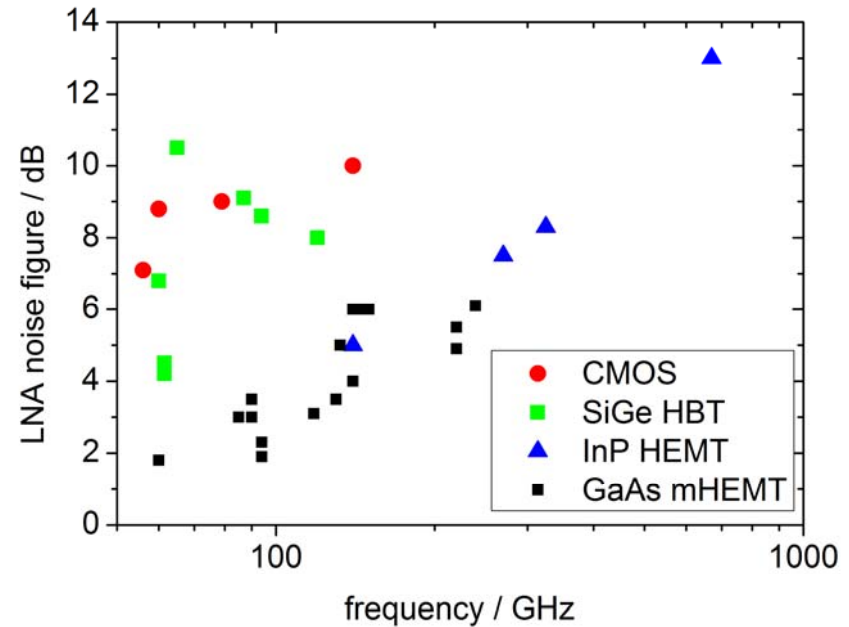
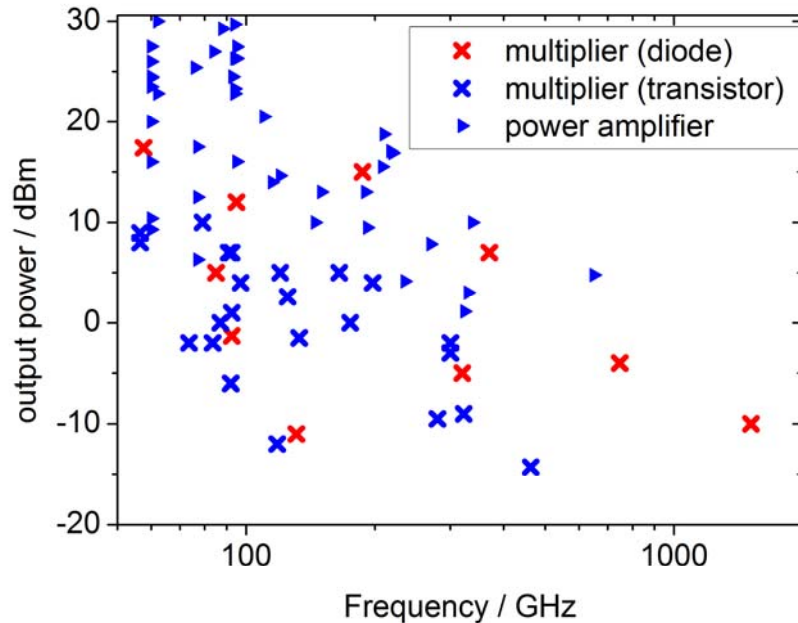

Applications decide on technology choice

Performance-driven

range (short < 1m < medium < 10m < long)
data rate (SNR)

Cost-driven

Mass markets → Si-based MMIC
Professional/niche markets → III-V based
MMIC, optical, diodes

Chip Set for 220 GHz Transmission

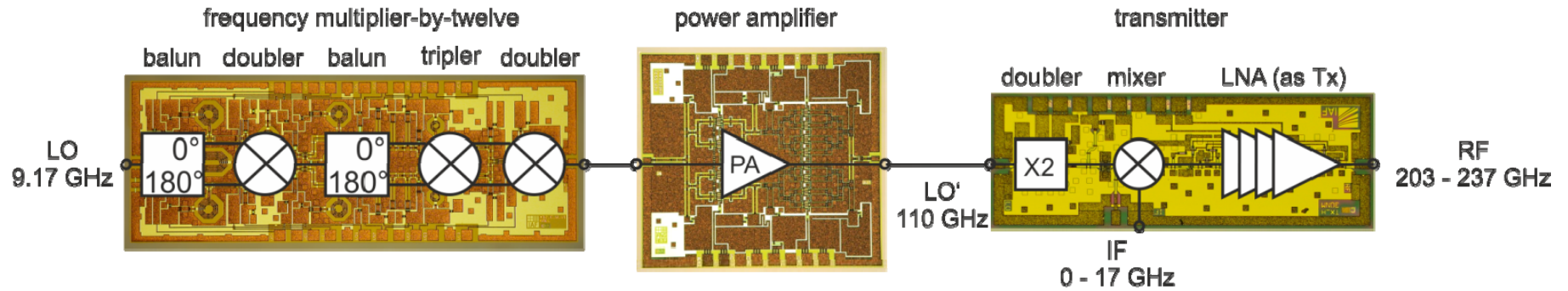

Technology: IAF 50 nm mHEMT f_T/f_{max} 515/900 GHz

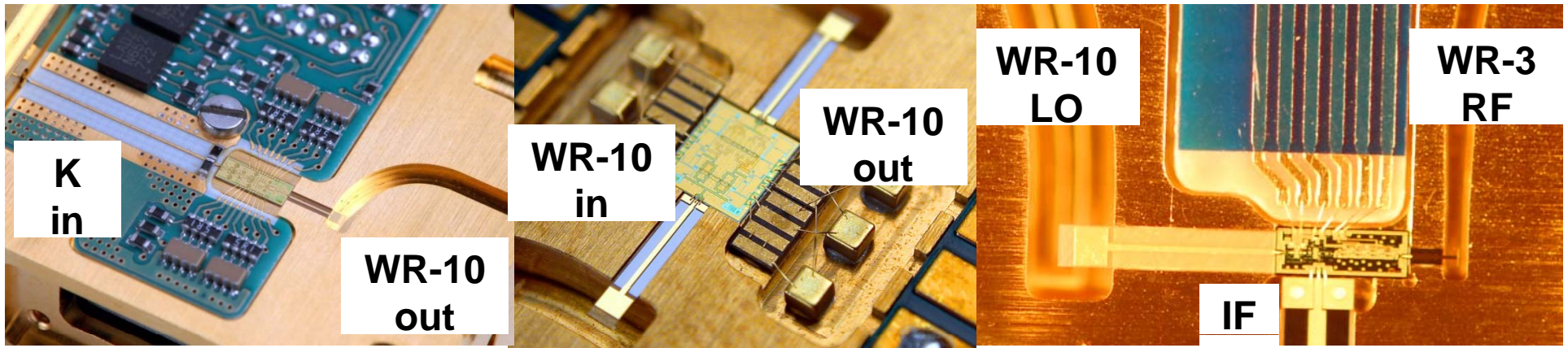

220 GHz Transmission Experiments

Setup	Rate	Dist.	Quality
Coherent LO	25 Gbit/s	10 m	$Q > 3$
	15 Gbit/s	20 m	
	Full DVB-S	20 m	n/a
	30 Gbit/s	n/a	$BER < 10^{-3}$
	16 Gbit/s	2 m	$Q^2 > 13.9$
Incoherent LO	16 APSK/ 1 GBd/s	3 m	EVM 9.7%
	QPSK/ 2 GBd/s	3 m	$BER 10^{-8}$

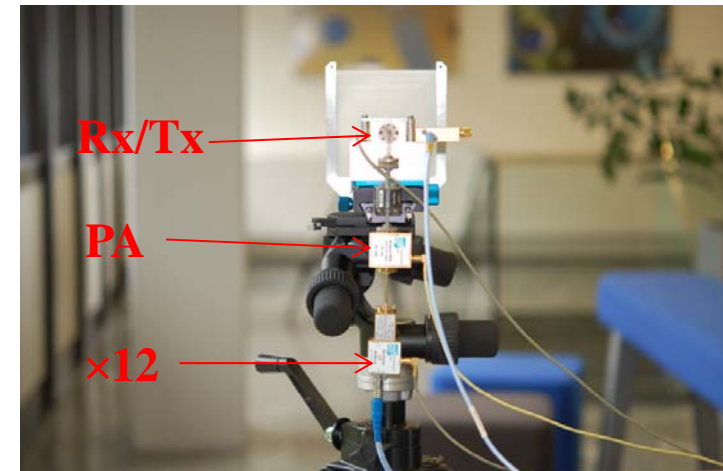
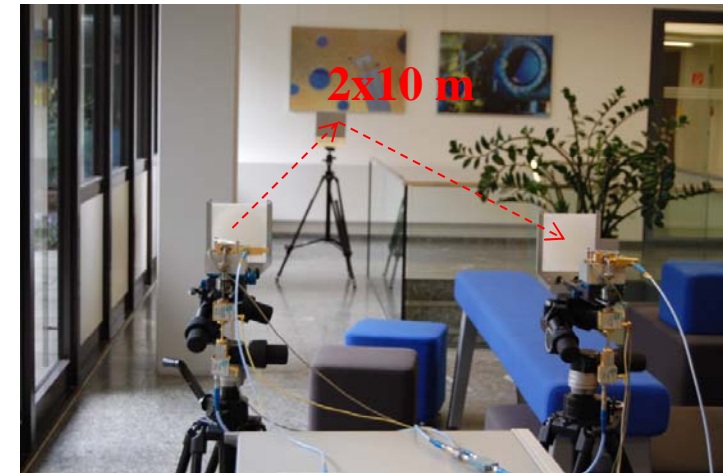

Antes et. al. EuMIC 2011

Outline

- Introduction - *Thomas Kürner*
- Technology Overview - *Ingmar Kallfass*
- **Application Kiosk Downloading** - *Katsuhiro Ajito*
- Application WLAN - *Akifumi Kasamatsu*
- New Wireless Networks - The Revolution of Multi-Gigabit Street Level Nanocells – *David Britz*
- Towards a Coexistent Spectrum Usage Between Active and Passive THz Systems - *Sebastian Priebe*
- Summary and Next Steps for the IG THz - *Thomas Kürner*

Application Kiosk Downloading

Katsuhiro Ajito^{1,2} Ho-Jin Song¹, Makoto Yaita¹, Takuro Tajima¹,
Naoya Kukutsu¹, Osamu Kagami¹

¹ NTT Microsystem Integration Laboratories, NTT Corp., Japan

² Secretary IEEE 802.15 IG THz

*This work was supported in part by the research and development program on Multi-tens gigabit wireless communication technology at subterahertz frequencies of the Ministry of Internal Affairs and Communications, Japan.

What is KIOSK Downloading?



□ Stationary transmitter

- Relatively free from size and power constraints
- Maybe connected to fiber-network
- Or embedded storage as a contents source

□ Mobile receiver

- Small dimension
- Low power consumption

□ No more than 1 meter distance

Use Case

- Ad posters in metro/trains or streets can be the front interface for downloading pre-fixed contents such as newly released movie trailers, full contents of Blu-ray disks, CDs, books, magazines..



One Possible Scenario

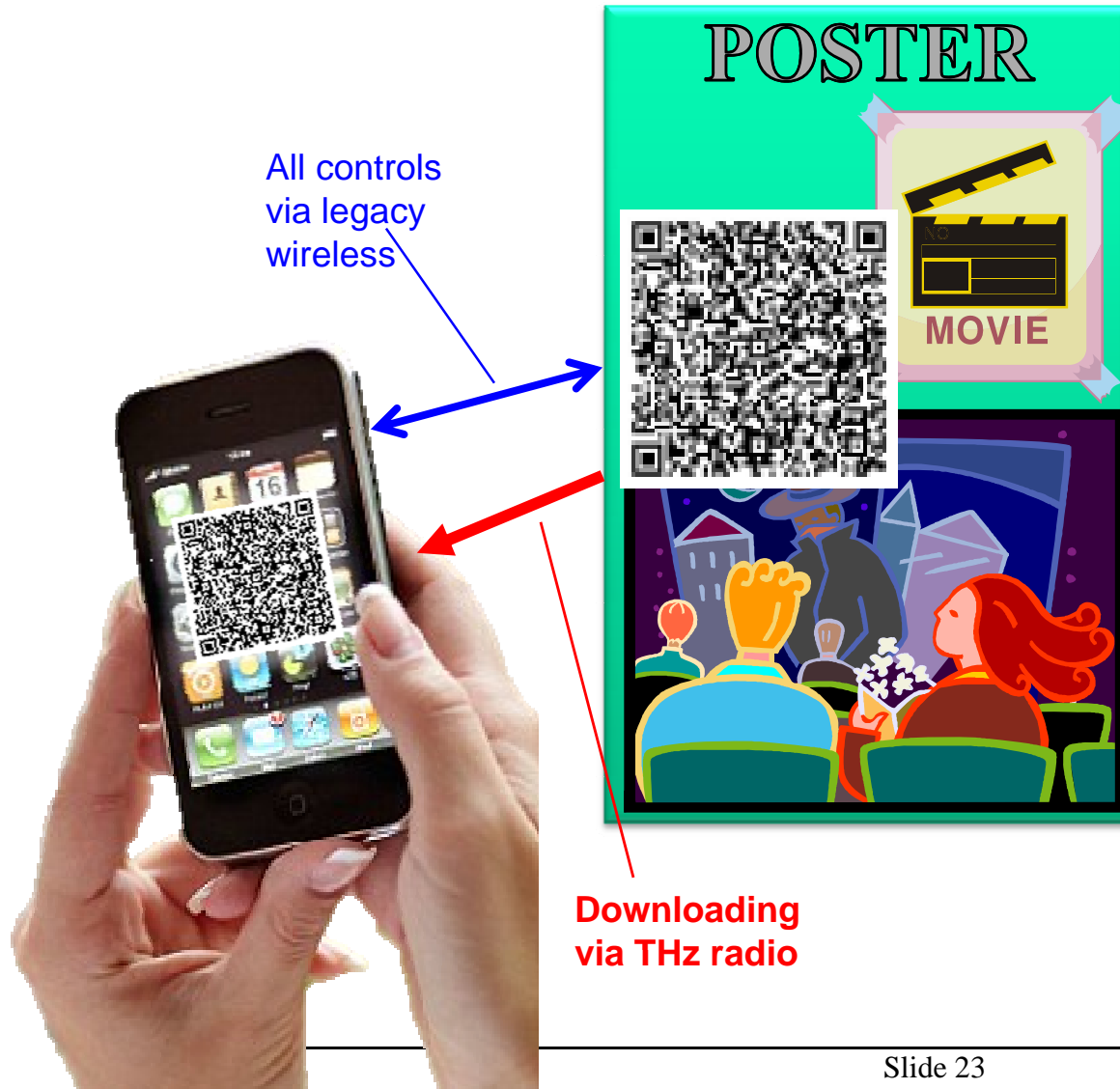

Brief scenario

- ① Rx reads a **QR code** including network configuration for downloading as well as other information.
- ② Rx sends Request To Open Session **via legacy wireless, e.g. Bluetooth.**
- ③ All other communications (security, payment) conducts **via the legacy**, except downloading data.
- ④ Tx sends data **via THz-radio.**

Link Budget

Quantity	Symbol	Value
Transmitting power	P_t	10 dBm
Carrier frequency	f_c	300 GHz
Wavelength	λ_c	1 mm
Distance	d	1 meter
Atmospheric attenuation	α_a	0.1 dB/m @ f_c
Noise spectral density	N_0	-178 dBm/Hz
Spectral efficiency		1 bps/Hz
Noise bandwidth	B	Data rate \times spectral efficiency
Total noise figure	NF	15 dB
System margin	M	10 dB

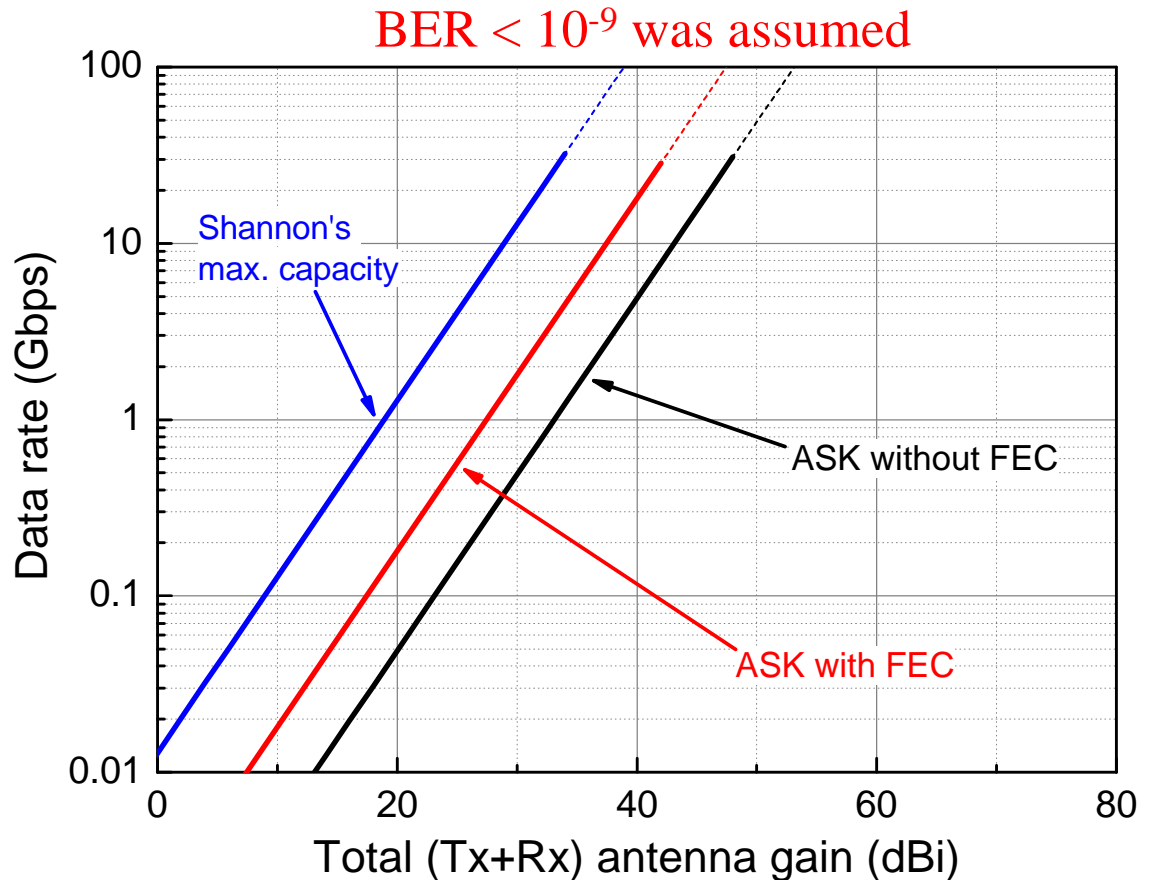

At 20 Gbps, Tx/Rx antennas together should provide more than 46-dBi gain.

Antennas for Rx

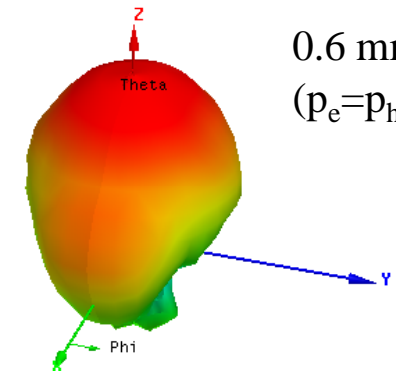
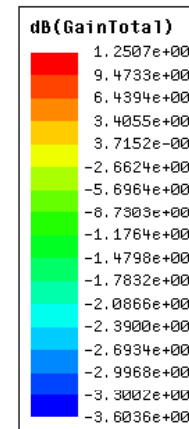
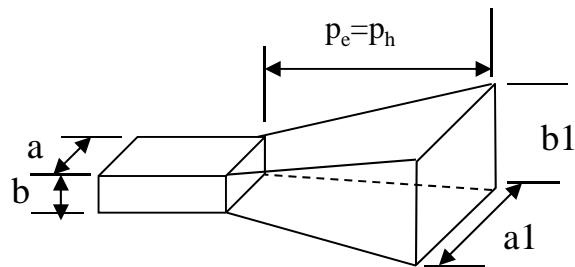

0.6 mm long
($p_e=p_h$) horn

- Standard Horn antenna for reference (@ 300 GHz),
 - ✓ >12 dBi with 0.6 mm long ($p_e=p_h$) horn
 - ✓ >15 dBi with 1.6 mm long ($p_e=p_h$) horn

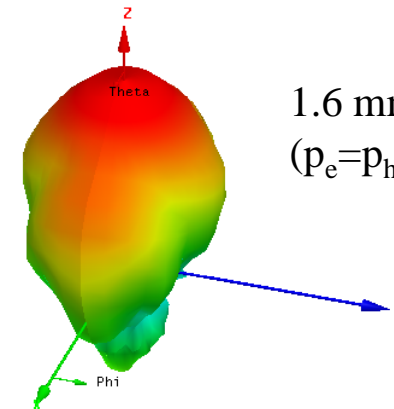
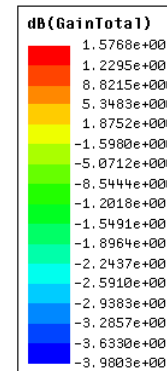

1.6 mm long
($p_e=p_h$) horn

A 12~16 dBi gain antenna would be available within a dimension of a few millimeters.

Antenna for Tx

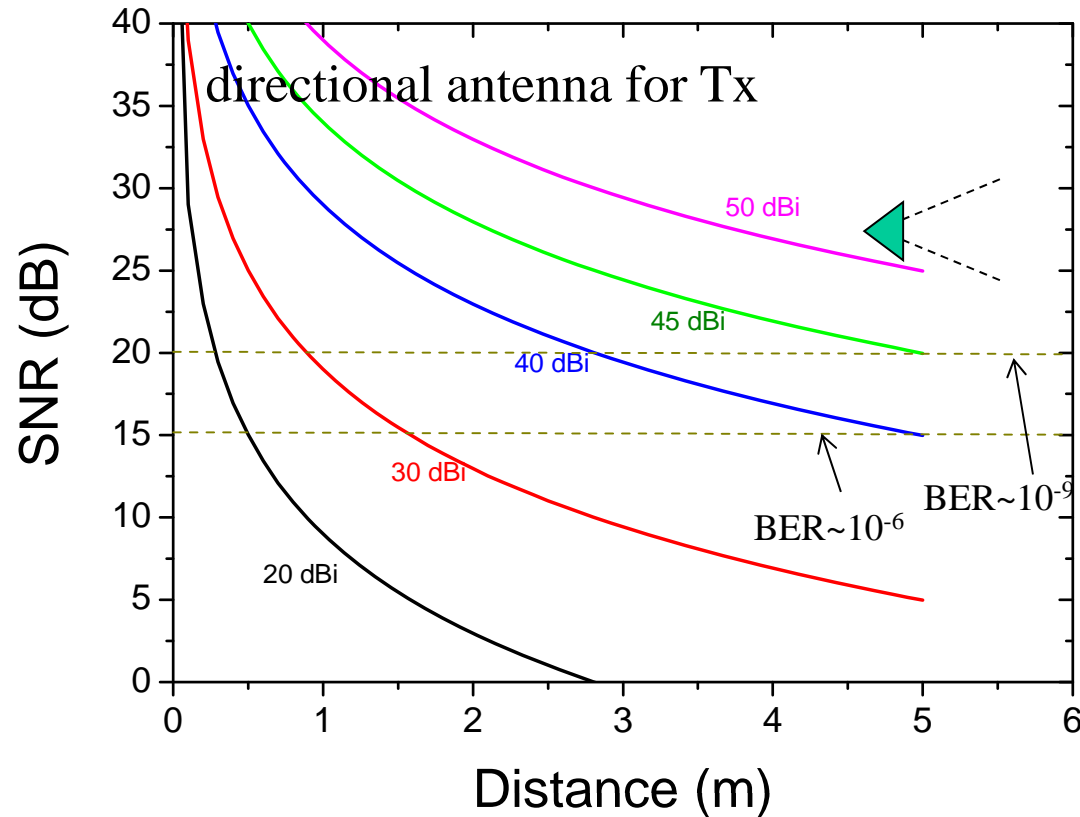

Calculation parameters

- @ 300 GHz
- $P_{TX} = 10$ dBm
- $NF_{RX} = 15$ dB
- Margin = 10 dB
- $AntennaGain_{RX} = 15$ dB
- Bandwidth = 30 GHz for 20-Gbps

For a 15-dBi Rx antenna, the Tx antenna must provide 30-dBi gain for $BER < 10^{-9}$.

Outline

- Introduction - *Thomas Kürner*
- Technology Overview - *Ingmar Kallfass*
- Application Kiosk Downloading - *Katsuhiro Ajito*
- **Application WLAN - *Akifumi Kasamatsu***
- New Wireless Networks – The Revolution of Multi-Gigabit Street Level Nanocells – *David Britz*
- Towards a Coexistent Spectrum Usage Between Active and Passive THz Systems - *Sebastian Priebe*
- Summary and Next Steps for the IG THz - *Thomas Kürner*

Application WLAN

Akifumi Kasamatsu¹

¹ NICT, Japan

Application WLAN

- Frequency and bandwidth
 - Several tens of GHz bandwidth within 275~400GHz
- Data rates
 - Several tens of Giga bit/s
- Transmission range
 - About 10m

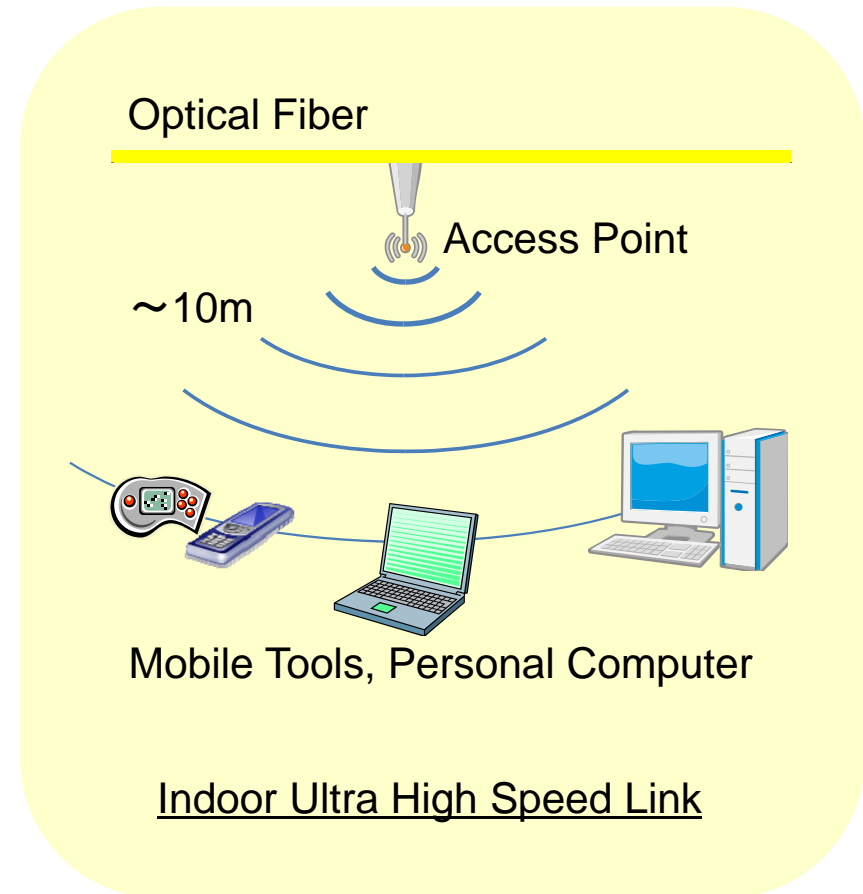

Application WLAN

- Wireless network topology
 - Star topology
 - Supporting multi-user spacial multiplex
- Hybrid with the other WLAN standards
- Antenna
 - Directional (but not so highly directive)
 - With support of beam steering
 - Antenna gain is asymmetric for Tx/Rx

Application WLAN

- Size, weight and power
 - Equivalent to conventional WLANs
 - Less than a few liters of volume, several hundreds gram of weight, and several tens of Watt of power consumption for an access point
 - Less than 1 Watt of power consumption for RF except for power amplifier

Comparison with recent WLAN standards

	11n		11ac		11ad		THz
	mandatory	optional	mandatory	optional	mandatory	optional	
Frequency	2.4GHz/5GHz		5GHz		60GHz		beyond 275GHz
Band Width	20MHz	40MHz	80MHz	160MHz	MAX. 9GHz		50GHz or more
Data Rate	72.2Mb/s	600Mb/s	290Mb/s	6.9Gb/s	4.6Gb/s	6.8Gb/s	Several tens of Gb/s or more

Required Antenna Gain

Item	Value
Modulation	OOK
Tx Power	20 dBm
Total NF	20 dB
Link Margin	10 dB
FEC	None
BER	10^{-9}

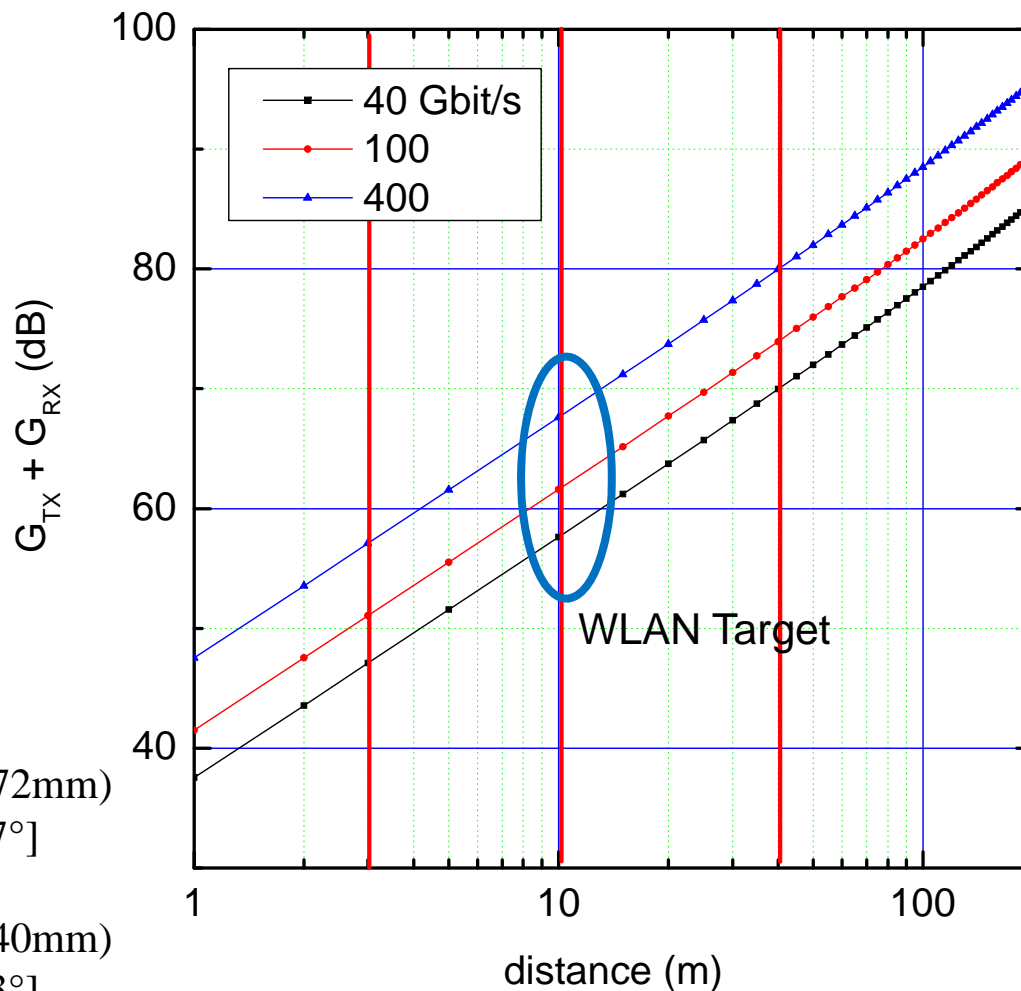

Antenna Gain for Tx and Rx

$(G_{TX} + G_{RX}) > 62\text{dB} @ 100\text{Gbps}, 10\text{m}$

Example 1:

Grx=15dB (d=1.8mm) Gtx=47dB (d=72mm)
 [25°] [0.7°]

Example 2:

Grx=20dB (d=3mm) Gtx=42dB (d=40mm)
 [17°] [1.3°]

Outline

- Introduction - *Thomas Kürner*
- Technology Overview - *Ingmar Kallfass*
- Application Kiosk Downloading - *Katsuhiro Ajito*
- Application WLAN - *Akifumi Kasamatsu*
- **New Wireless Networks - The Revolution of Multi-Gigabit Street Level Nanocells – *David Britz***
- Towards a Coexistent Spectrum Usage Between Active and Passive THz Systems - *Sebastian Priebe*
- Summary and Next Steps for the IG THz - *Thomas Kürner*

New wireless networks - The revolution of multi-gigabit street level nanocells

David Britz¹

¹ AT&T Shannon Labs, USA

Vice-Chair IEEE 802.15 IG THz

The Problem... Street level cell phone connectivity

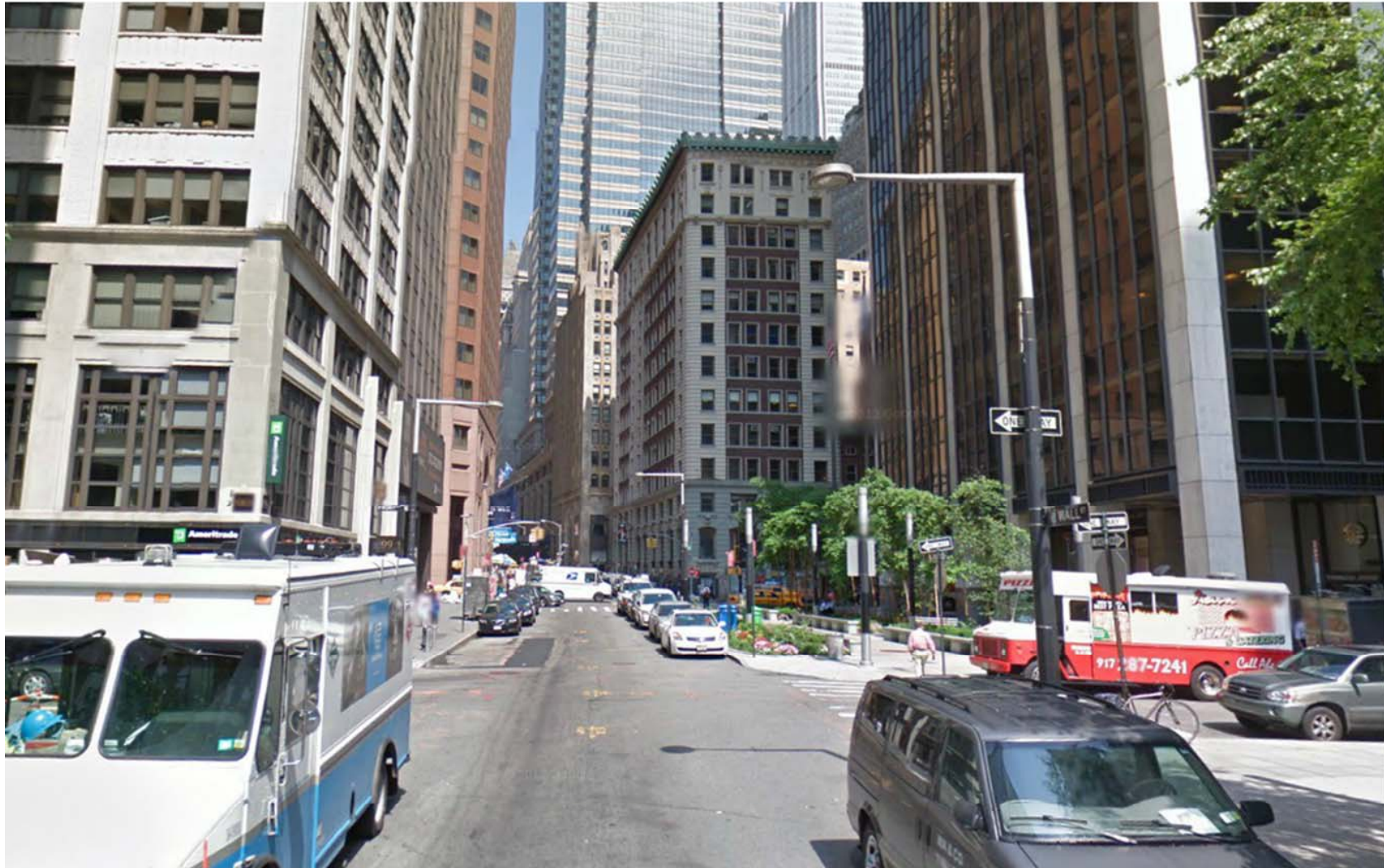

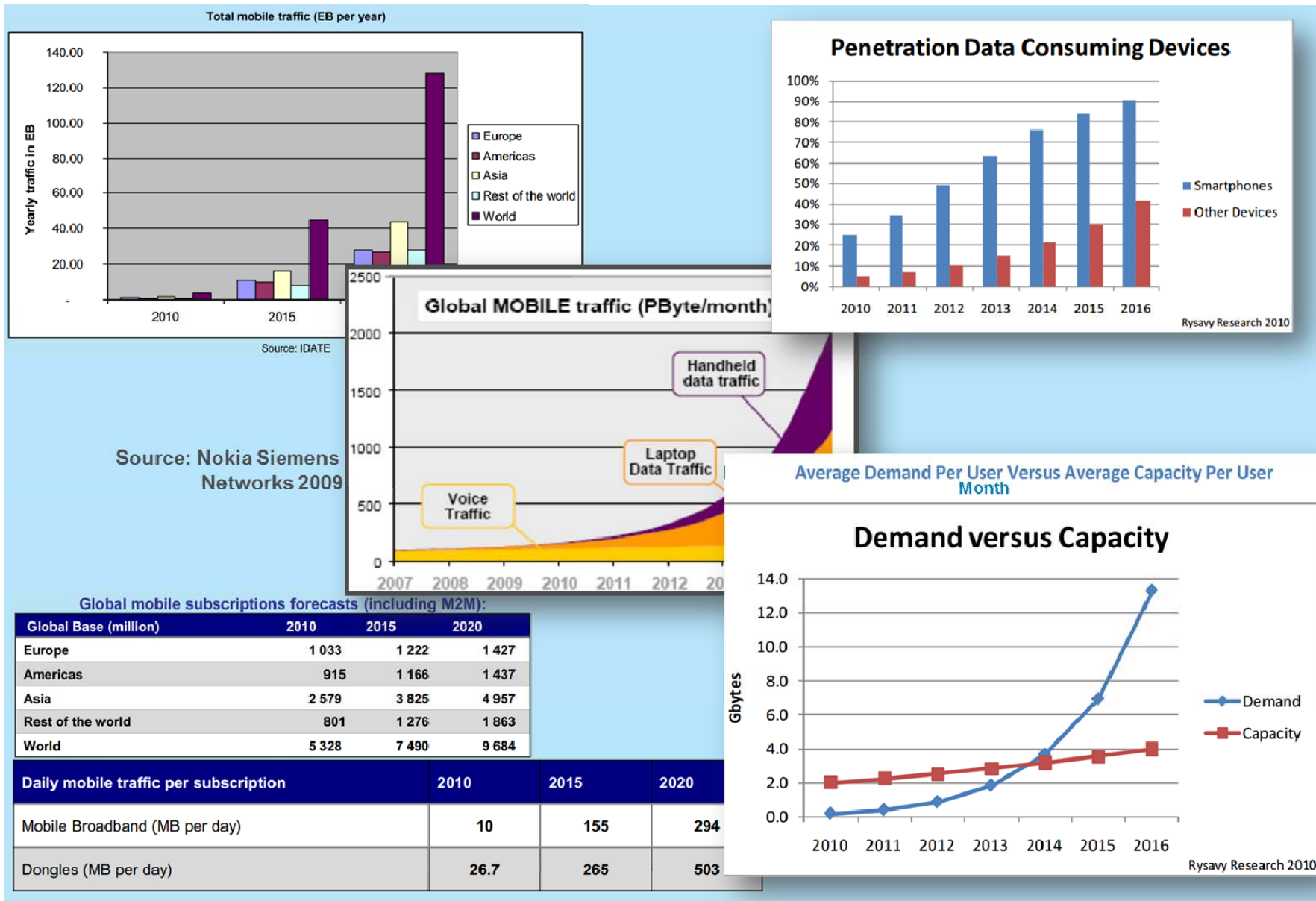

The Incredible Shrinking Cell

- Increased Bandwidth Demand/User
- Battery/Dissipation Device Constraints
- Moore's Law Radios
- Increased Edge Intelligence
- Distributed Control Techniques

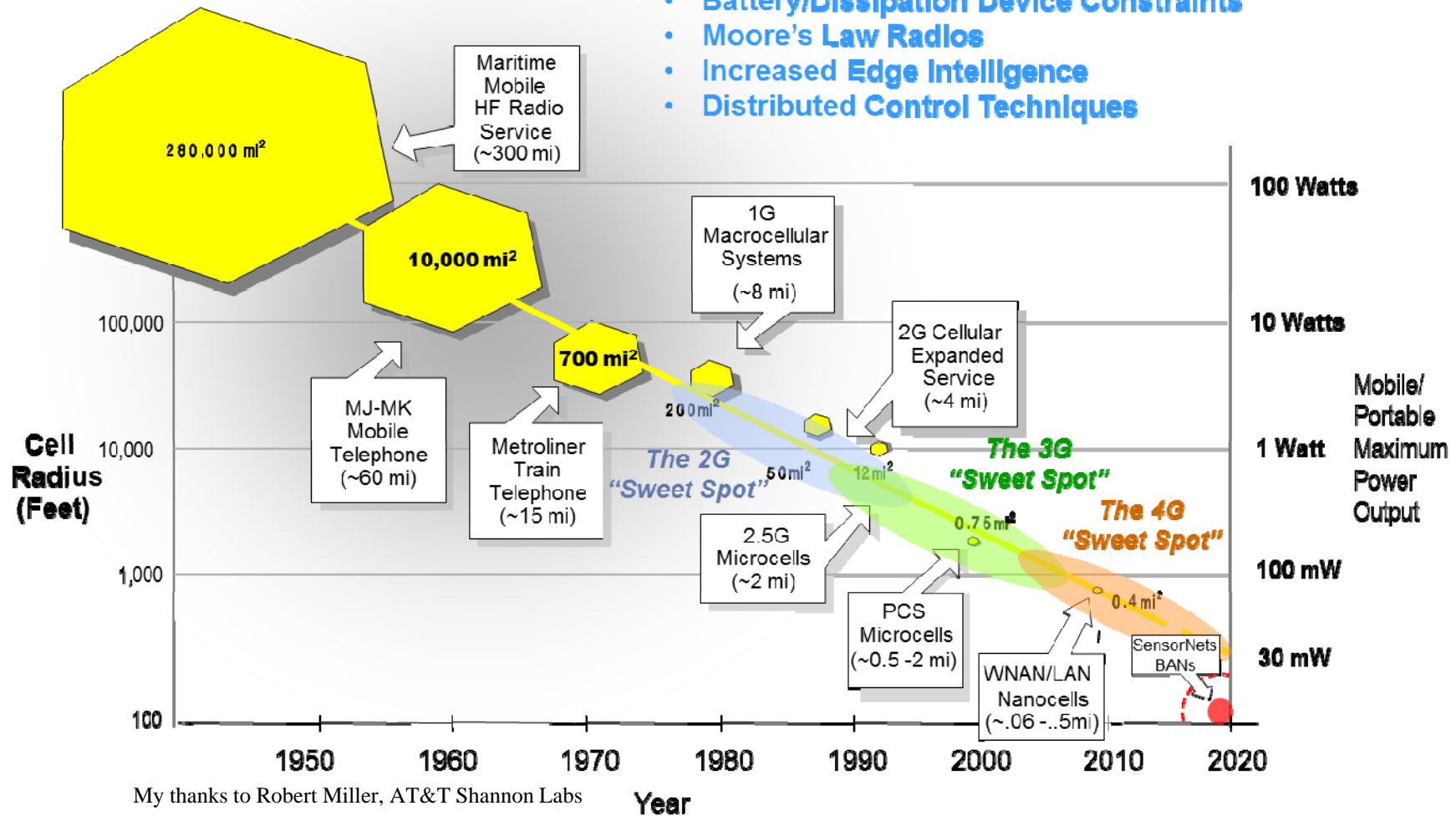

Envisioning Multi Layered Communications and Interactive Sensor "Cloud" Wireless Networks

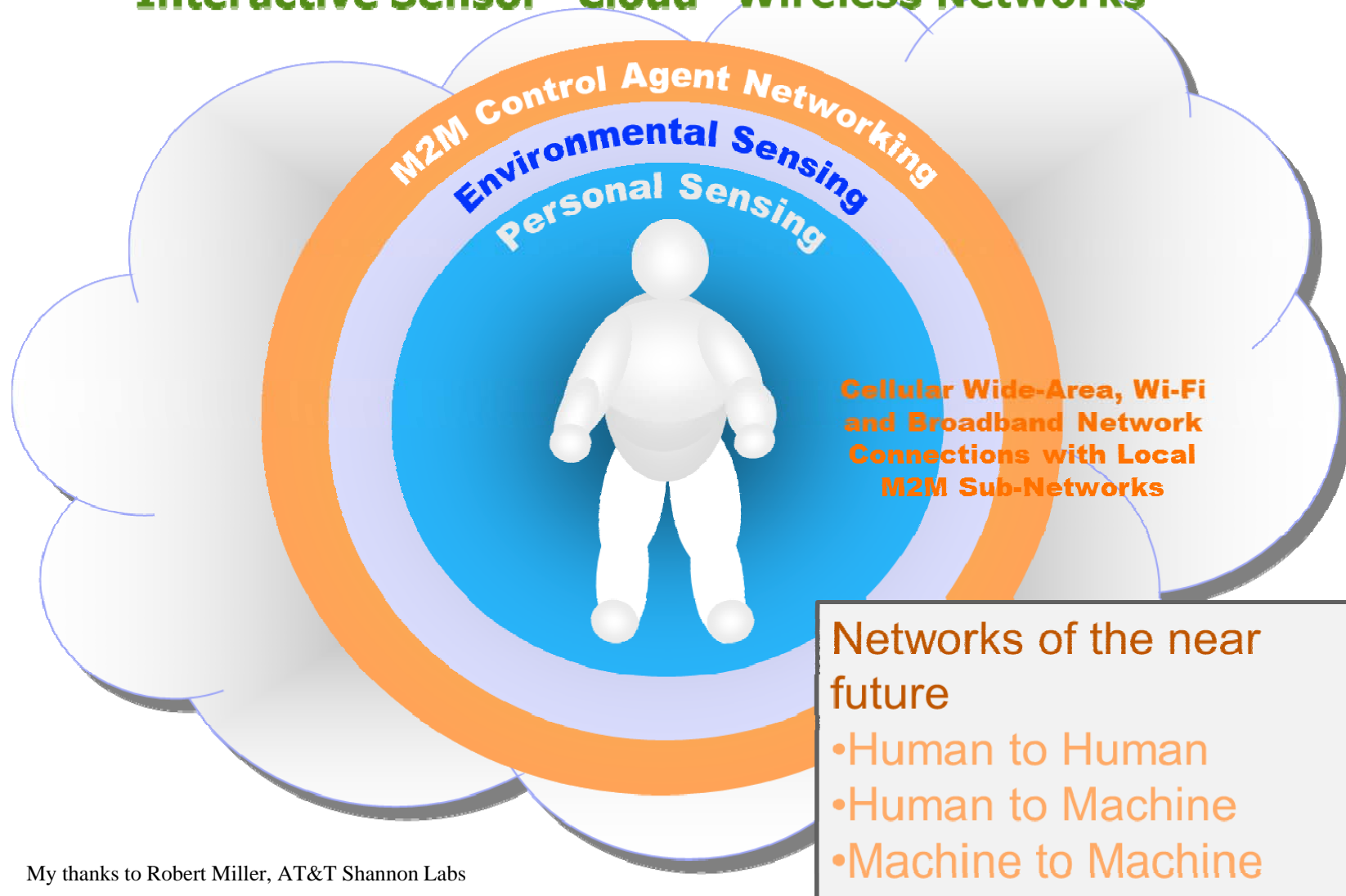

My thanks to Robert Miller, AT&T Shannon Labs

Multi-Gigabit Wireless Networks: Where are We?

- Out of necessity, **wireless service providers are beginning to meter data usage** to conserve spectrum resources in response to burgeoning demand for data connectivity.
- **Cellular networks are evolving to smaller coverage area**, higher teledensity cells to deliver more bandwidth and to reuse spectrum more intensely.
- Even with aggressive network infrastructure investment, a **new generation of users and applications are continuing to challenge wireless network capacity**: "always on" multimedia-connected individuals and sensor clouds, 3D video, and augmented reality are preparing to enter the mainstream.
- Current cellular/wireless LAN technologies and spectrum roadmaps may struggle to keep pace with emerging wireless connectivity demands and evolving user behavior. **Without new spectrum and network architectural approaches it is unlikely that Gigabit wireless Common Air Interfaces in high teledensity areas can arise.**
- Perception of rate requires about a power of 10 for "Oh Wow!" factor (e.g. Ethernet)
- **Years ago, AT&T-developed cellular microwave communications was a similar disruptive concept that spawned many technological advances.**
- **Terahertz example: "Yesterday Once More"--- the 1930's again!**
 - **Abundant bandwidth**
 - **Simple radios**
 - **Spectrum "AI"**
 - **New architectures**
 - **New applications**

Street Level Small Cell Networks Using 60+GHz for Aerial Conduit Inter-Small Cell Backhaul

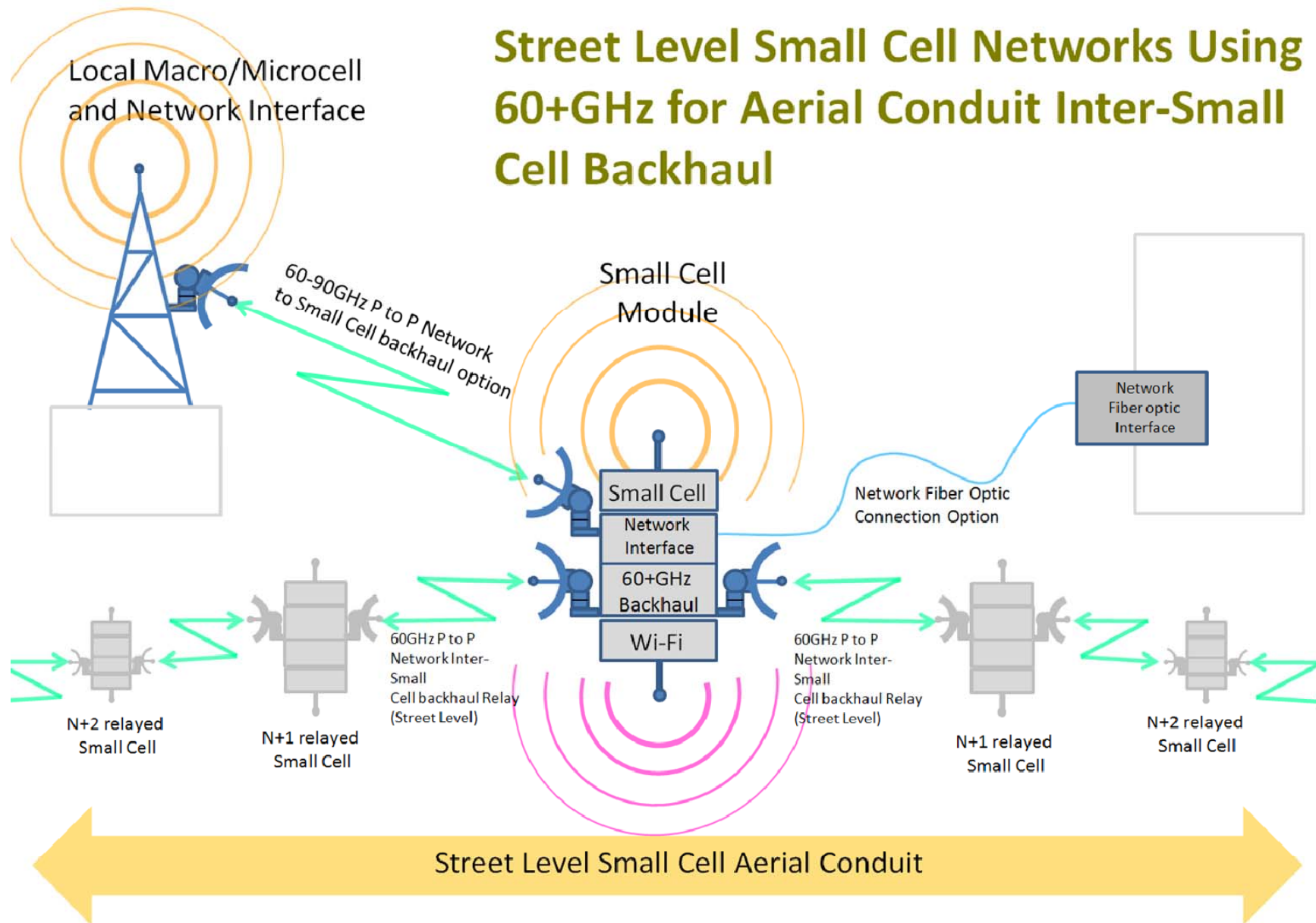

Deployment Strategies

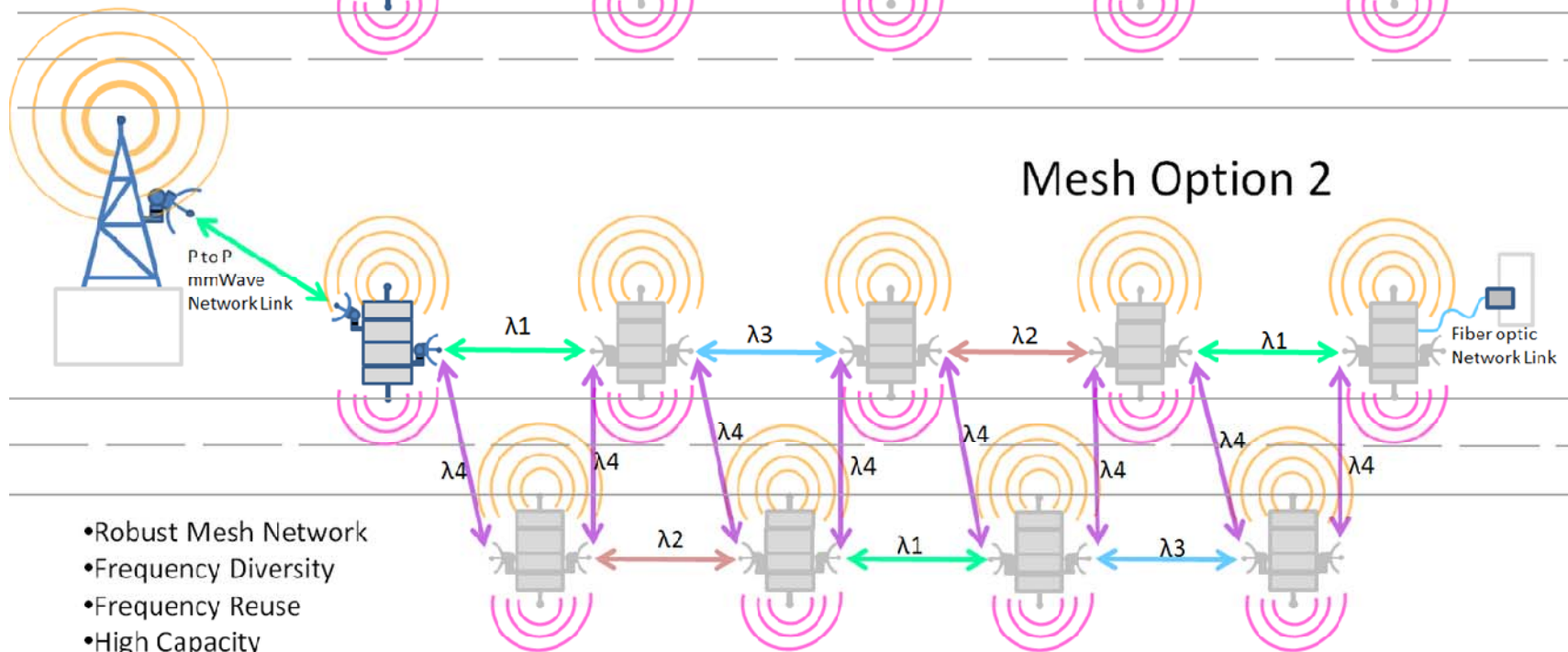
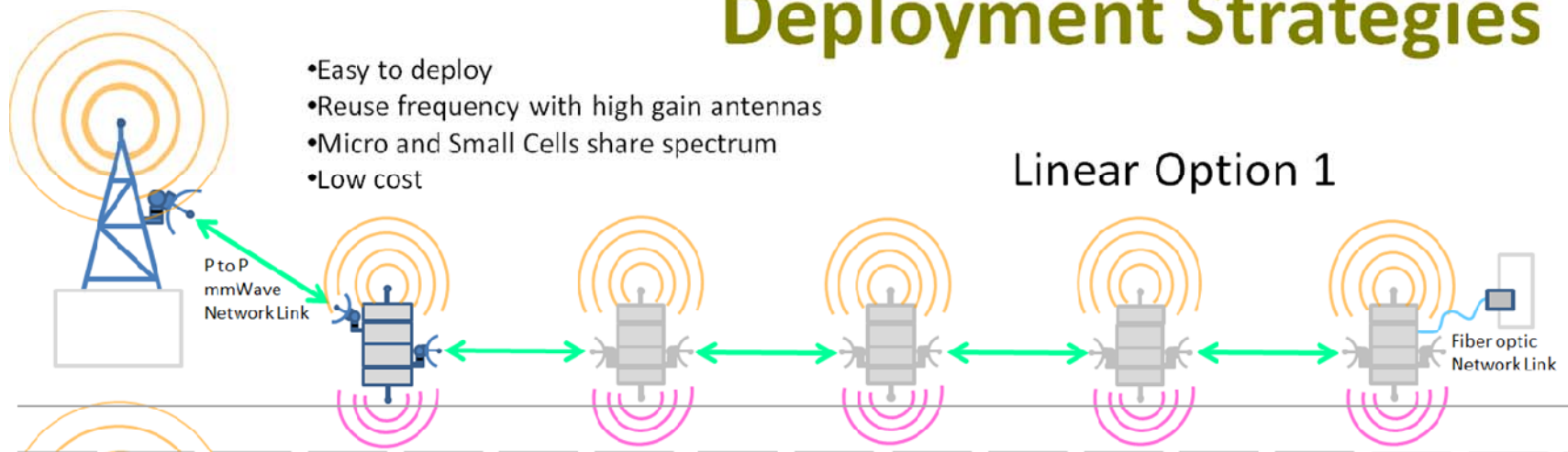

- Robust Mesh Network
- Frequency Diversity
- Frequency Reuse
- High Capacity
- Low Interference

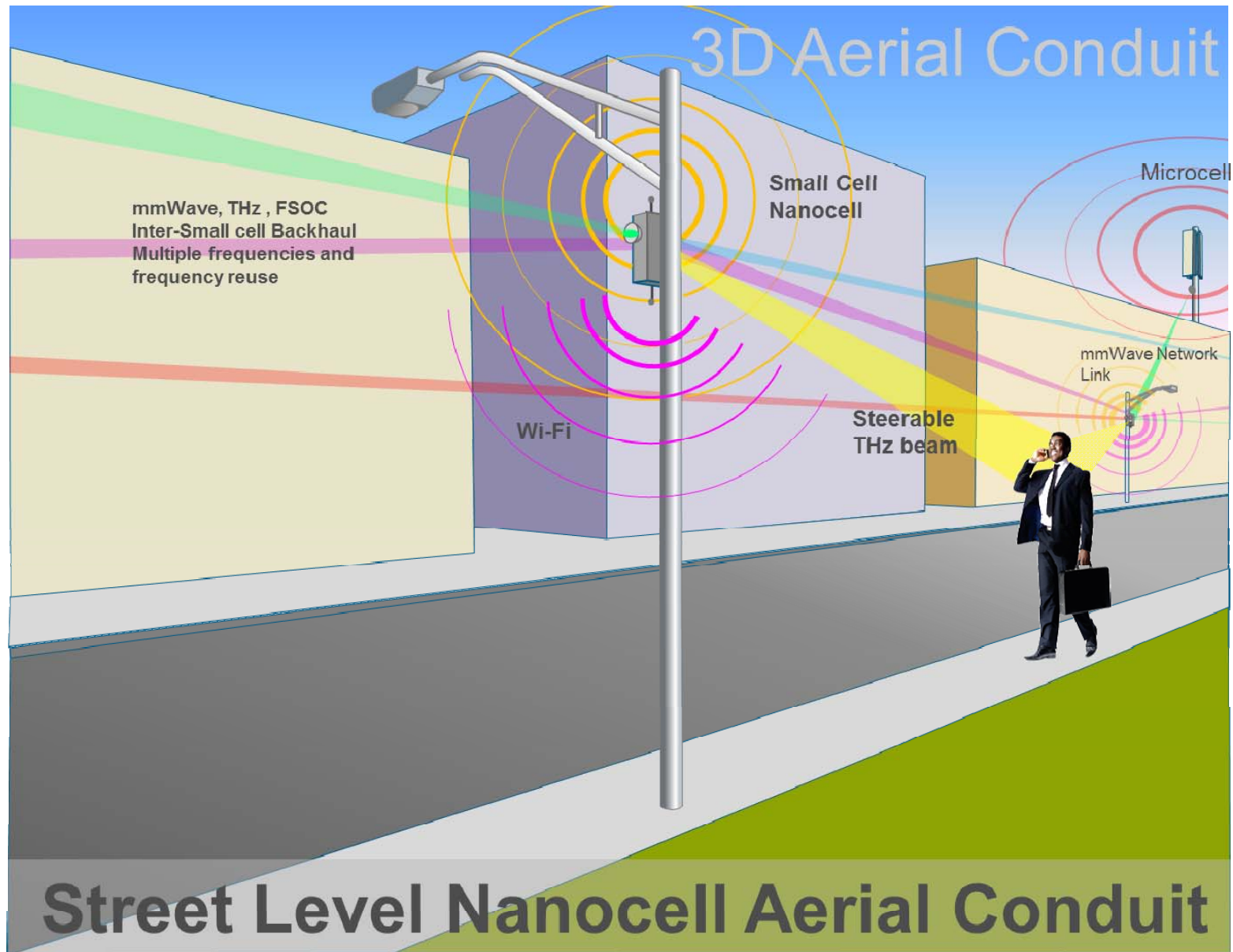

The Solution... Nanocell street level smartdevice connectivity with 60-600GHz backhaul and directional beams

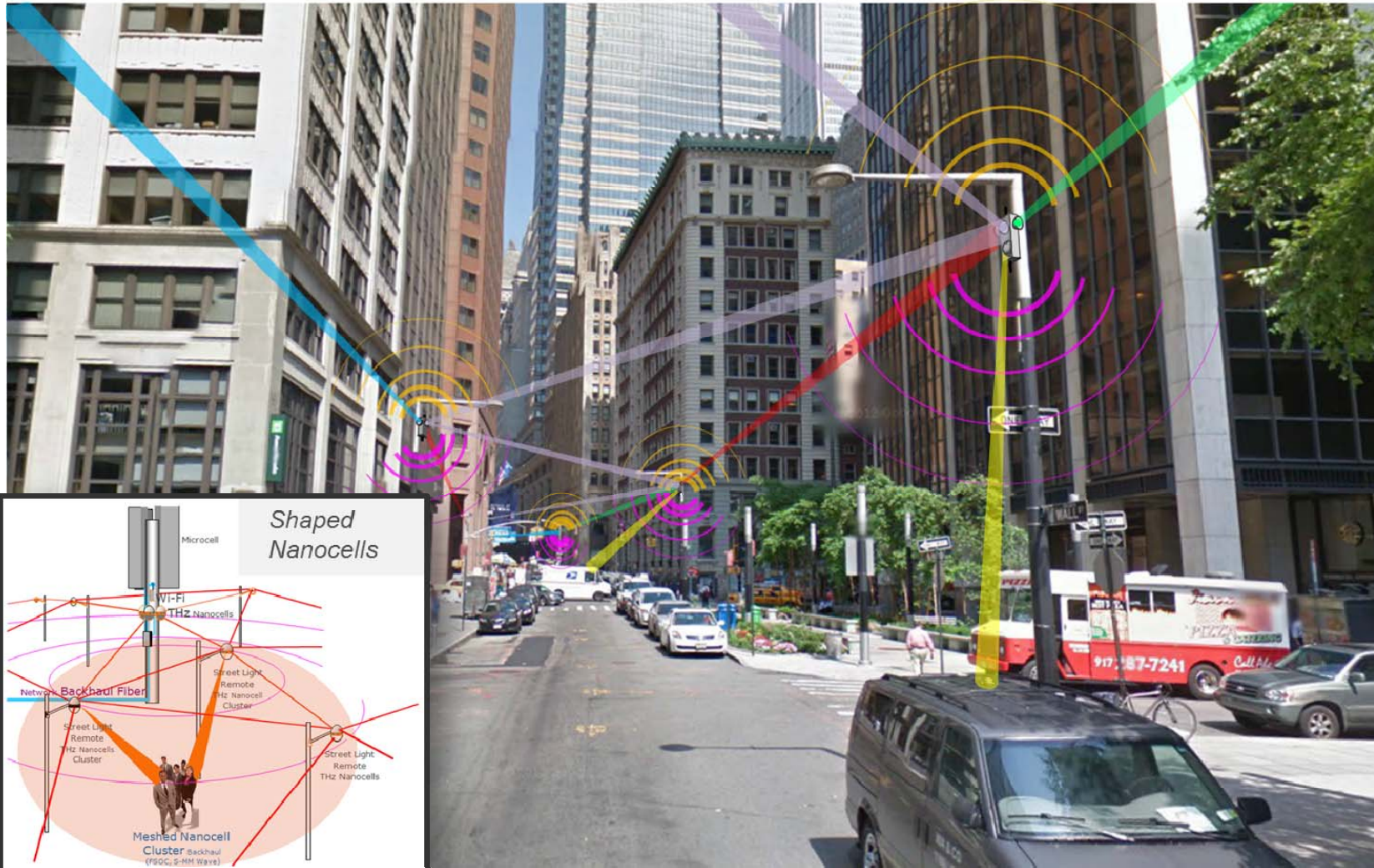

Outline

- Introduction - *Thomas Kürner*
- Technology Overview - *Ingmar Kallfass*
- Application Kiosk Downloading - *Katsuhiro Ajito*
- Application WLAN - *Akifumi Kasamatsu*
- New Wireless Networks - The Revolution of Multi-Gigabit Street Level Nanocells – *David Britz*
- **Towards a Coexistent Spectrum Usage Between Active and Passive THz Systems - *Sebastian Priebe***
- Summary and Next Steps for the IG THz - *Thomas Kürner*

Towards a Coexistent Spectrum Usage Between Active and Passive THz Systems

Sebastian Priebe¹

¹ Terahertz Communications Lab,
Institut für Nachrichtentechnik, Technische Universität Braunschweig, Germany

Introduction (1)

ITU Radio Regulations Footnote 5.565:

The frequency band 275-1000 GHz may be used by administrations for experimentation with, and development of, various active and passive services.

- Radio astronomy service: 275-323 GHz, 327-371 GHz, 388-424 GHz, [...]
- Earth exploration-satellite service and space research service 275-277 GHz, 294-306 GHz, 316-334 GHz, [...]

Administrations are urged to take all practicable steps to protect these passive services from harmful interference.



→ Two options for THz communications:

1. Transmission in remaining free parts of the THz spectrum
2. Coexistent spectrum usage with radio astronomy/earth exploration

Introduction (2)

1. Transmission in remaining bands only
 - Very small bandwidths
 - Distributed over entire THz range

→ **Not feasible** for data rates $\gg 10$ Gbit/s

2. Coexistent spectrum usage
 - Potential interference of active THz systems with
 - radio astronomy
 - spaceborn THz sensors

→ **Interference investigations** inevitable for standardization to comply with the ITU Radio Regulations

Remaining Frequency Bands	Total available Bandwidth
286-294 GHz	8 GHz
307-313 GHz	6 GHz
356-361 GHz	5 GHz
366-369 GHz	3 GHz
392-397 GHz	5 GHz
399-409 GHz	10 GHz
411-416 GHz	5 GHz
434-439 GHz	5 GHz
467-477 GHz	10 GHz
502-523 GHz	21 GHz
527-538 GHz	11 GHz
581-611 GHz	30 GHz

Interference with Radio Astronomy

- Studies available by the National Science Foundation
- Distance of THz transmitter from telescope for interference-free conditions in accordance with ITU protection criteria RA.769:
 - *Worst case*: TX pointed directly in direction of telescope at same altitude

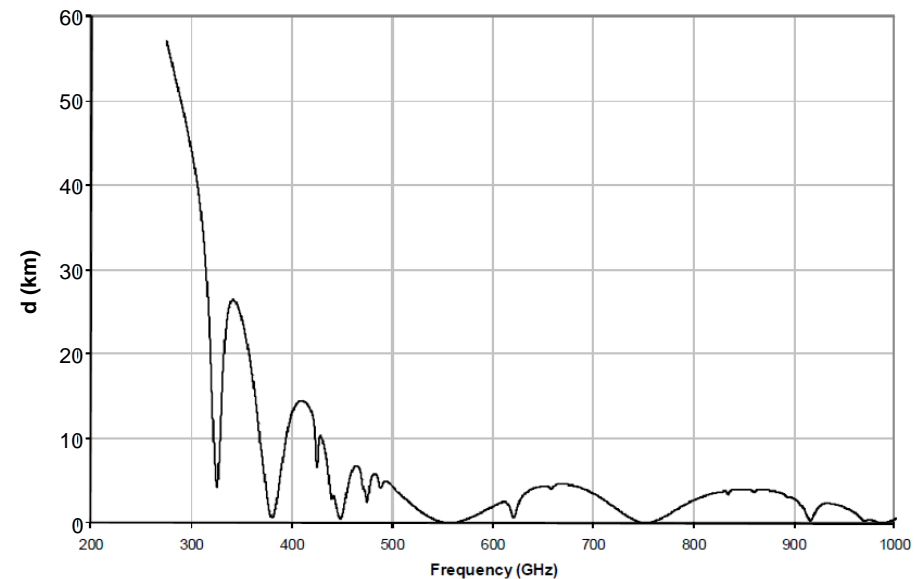
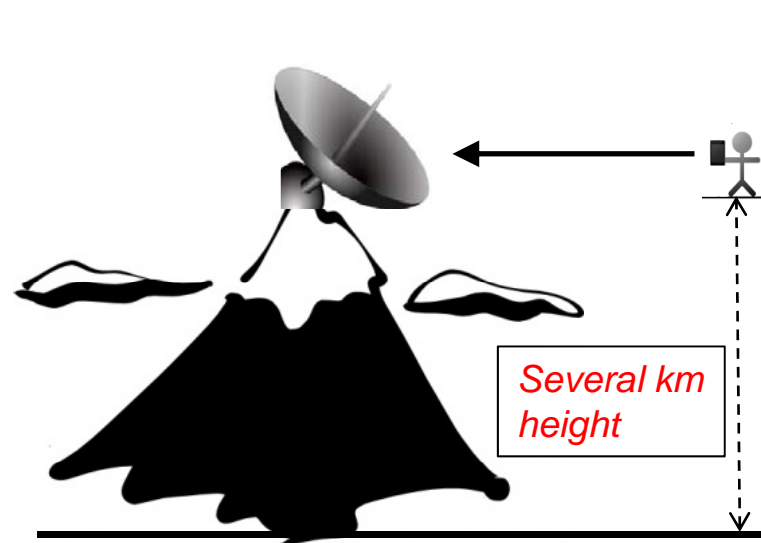

→ **Interference in practice extremely unlikely** due high telescope locations on mountains

Interference with Earth Exploration (1)

- THz transmitters operated outdoor may be pointed skyward:

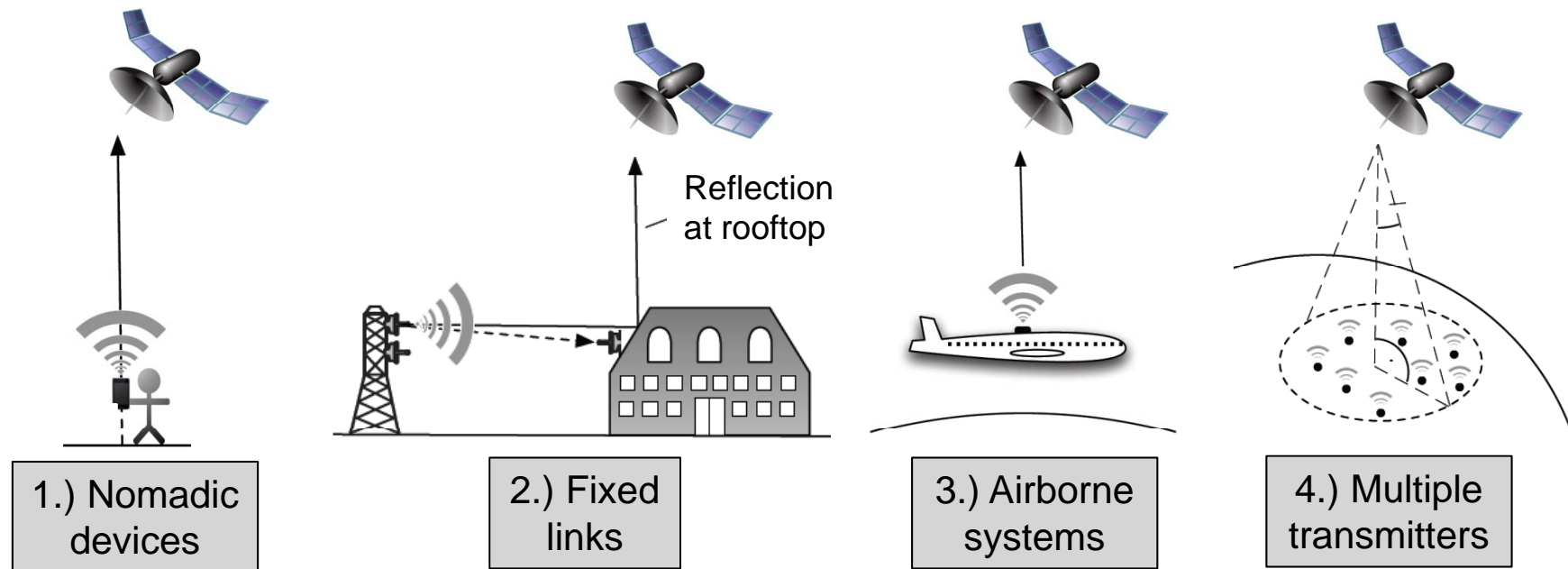

- Which is the **maximum tolerable interference power**?
- How much power will be received by the satellite in the **worst case**?

Interference with Earth Exploration (2)

- Determination of maximum allowed TX output powers for interference-free conditions:

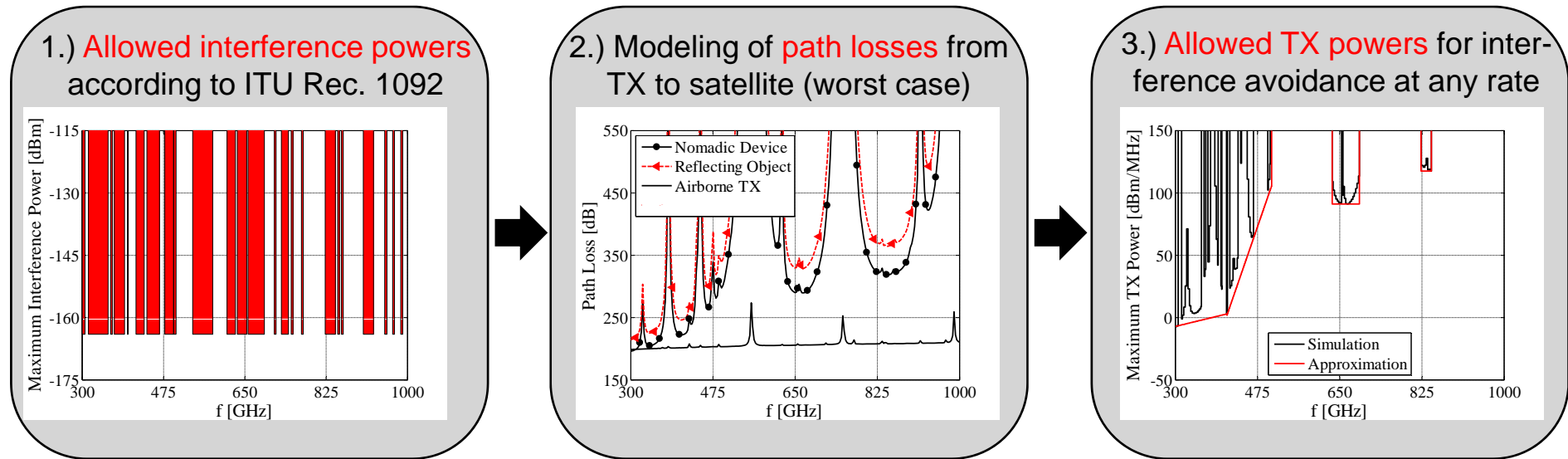

- Interference possible under worst case assumptions
- Definition of transmit power masks
- Limitation of output powers to several 10 dBm

Interference with Earth Exploration (3)

- Maximum allowed isotropic transmit powers (worst case):
 - QPSK modulation
 - 25 dBi RX antenna gain (nomadic, inflight), 55 dBi (fixed link)
 - 5 dB RX noise figure

		300 – 320 GHz	385 – 435 GHz	
		40 Gbit/s	100 Gbit/s	
(1) Nomadic TX	$P_{TX,Max}$	35.9 dBm	47.6 dBm	WPAN/ WLAN
	d_{Max}	33 m	52 m	
(2) Fixed link	$P_{TX,Max}$	40.9 dBm	60.9 dBm	Backhaul link
	d_{Max}	964 m	727 m	
(3) Inflight	$P_{TX,Max}$	20.5 dBm	19.9 dBm	Inflight entertainment
	d_{Max}	12 m	3 m	

- Sufficient powers allowed to achieve acceptable distances
- **Interference mitigation** required for higher powers/longer ranges

Interference Mitigation Concepts

1. Transmit power masks
 - TX power control
2. Automatic shutdown in case of TX mispointing
 - Sensor data usage (e.g. orientation and position)
3. Electrically steerable antennas
 - Automatic precise beam pointing
4. Environment control
 - Fixed links
 - Airborne systems
 - Careful TX placement
 - Absorbing materials

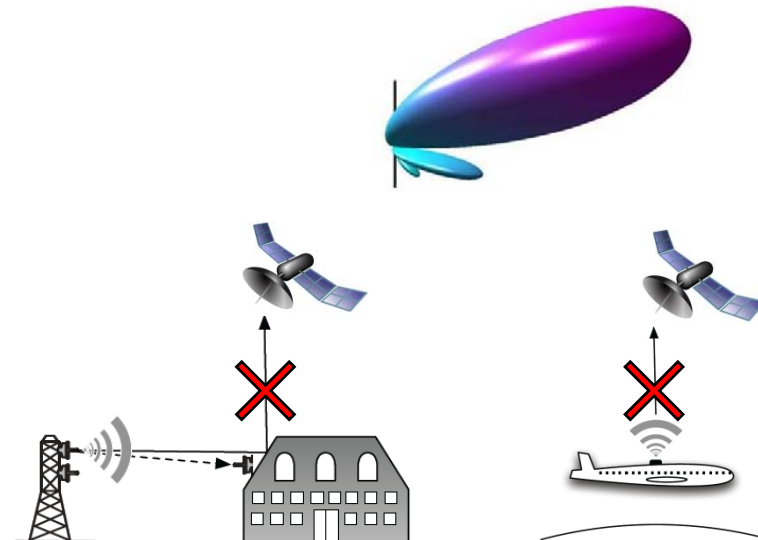
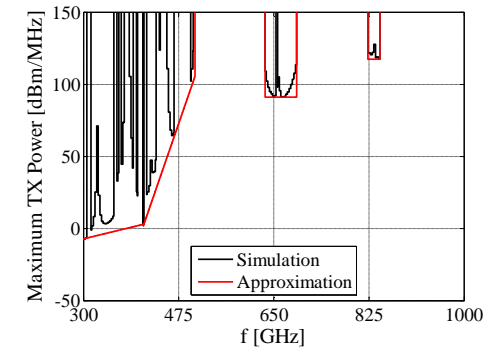

→ **Avoidance of interference in any case** with interference mitigation

Outline

- Introduction - *Thomas Kürner*
- Technology Overview - *Ingmar Kallfass*
- Application Kiosk Downloading - *Katsuhiro Ajito*
- Application WLAN - *Akifumi Kasamatsu*
- New Wireless Networks - The Revolution of Multi-Gigabit Street Level Nanocells – *David Britz*
- Towards a Coexistent Spectrum Usage Between Active and Passive THz Systems - *Sebastian Priebe*
- **Summary and Next Steps for the IG THz - *Thomas Kürner***

Summary and Next Steps for the IG THz

Thomas Kürner¹

¹ Terahertz Communications Lab,
Institut für Nachrichtentechnik, Technische Universität Braunschweig, Germany

Chair IEEE 802.15 IG THz

Conclusions from the previous Presentations

- Recent achievements in technology development have clearly shown that building wireless systems with ultra-high data rates @ carrier frequencies of 300 GHz and beyond is feasible.
- First successful demonstrations of wireless data rates 25 Gbit/s over a distance of 10m
- Various applications feasible for THz communications are under consideration in numerous research projects
- Although some sharing issues still exist, the assumption can be made that appropriate spectrum is available.

Current Situation in the Development of THz Communications

- Since 2008, when the IG THz was established, many technology, regulatory and market boundary conditions have improved:
 - Progress in semiconductor technology
 - WRC 2012 resulted in a stable situation in terms of spectrum activity
 - Worldwide many research projects on THz communications have been started (e. g. in Korea, Japan and Germany)
 - Industry shows some interest now, see e. g. the International Wireless Industry Consortium (IWPC) has established a Millimeter and sub-Millimeter Wave Nanocell Working Group (<http://www.iwpc.org/WorkingGroups.aspx>)

Heading towards one or more Standards in THz Communications

- It's time to think about triggering the process of generating one or more standards for THz Communications
- Presentations to the IG THz on possible applications have clearly shown that the various applications require also solutions with different technical complexities

Possible Applications and Complexity of the Technical Solutions

Application	Operational Environment	Typical Range	Specific Propagation Conditions	Requirements for Antenna Alignment
Fixed Wireless Links	Links of the backbone network; static use; outdoor	A few hundred meters up to several kilometers	LOS; Atmospheric attenuation becomes important	Highly directive antennas; alignment during the installation process by radio engineers
THz Nano Cells	Part of a hierarchical cellular network; potentially mobile users; indoor as well as outdoor	< 100m	LOS/NLOS; dynamically changing conditions	automatic beam steering required
WLAN/WPAN	Connection to access points; nomadic users; mainly indoor	< 100m (mostly < 10m)	LOS/NLOS; dynamically changing conditions	automatic beam steering required
Kiosk Downloading	indoor, nomadic use	A few meters (a few cm)	LOS, multiple reflections from Tx and Rx	automatic beam steering (manual alignment may be possible)
Connecting Devices on Short Ranges	indoor (typically on a desktop), nomadic use	a few cm	LOS, multipaths from nearby objects and multiple reflections from Tx and Rx	ideally by automatic beam steering, but manual alignment may be possible
Board-to-Board Communication	inside computers, fixed use	a few cm	LOS/NLOS, potentially strong multipaths	fixed alignment during design process possible (automatic beam steering as an option)

Source: based on <https://mentor.ieee.org/802.15/dcn/11/15-11-0749-00-0thz-scenarios-for-the-application-of-thz-communications.pdf>

Pre-requisites for starting a Study Group

- As a consequence of the varying complexity of technical solutions attached to the different applications instead of a single standard rather a set or a family of individually applicable standards may be required.
- A reasonable starting point is to begin with an application that requires less complex solutions, e. g. a kiosk downloading application.
- To start a study group, a more expanded engagement and commitment with appropriate participation from industry and industry groups such as the IWPC would be beneficial.
- Current contributions in the IG THz are clearly focusing on PHY issues. More participants in the IG THz with expertise on MAC are welcome.

Thank you for your attention!

For more details see <http://www.ieee802.org/15/pub/IGthz.html>

IEEE 802.15 WPAN™
Terahertz Interest Group (IGthz)

