

Project: IEEE P802.15 Working Group for Wireless Personal Area Networks (WPANs)

Submission Title: [Cooperative Channel Segmentation for Interference Mitigation in the 2.4GHz Band]

Date Submitted: [16 Mar, 2012]

Source: [Yukimasa Nagai] Company [Mitsubishi Electric Corp.]

Address [5-1-1, Ofuna, Kamakura, Kanagawa, 247-8501, JAPAN]

Voice:[+81-467-41-2115], FAX: [], E-Mail:[Nagai.Yukimasa@ds.MitsubishiElectric.co.jp]

Re: []

Abstract: [This presentation shows effectiveness of our proposed CCS for interference mitigation between Bluetooth and WLAN.]

Purpose: [For discussion.]

Notice: This document has been prepared to assist the IEEE P802.15. It is offered as a basis for discussion and is not binding on the contributing individual(s) or organization(s). The material in this document is subject to change in form and content after further study. The contributor(s) reserve(s) the right to add, amend or withdraw material contained herein.

Release: The contributor acknowledges and accepts that this contribution becomes the property of IEEE and may be made publicly available by P802.15.

Cooperative Channel Segmentation for Interference Mitigation in the 2.4GHz Band

Authors:

Name	Affiliations	Address	Phone	email
Yukimasa Nagai	Mitsubishi Electric	5-1-1 Ofuna, Kamakura 247-8501, JAPAN	+81-467-41-2115	Nagai.Yukimasa@ ds.MitsubishiElectr ic.co.jp

Background

- As the variety of portable device applications has been increasing, portable devices such as smart phones, tablets and netbooks carry two or more kinds of wireless network interfaces.
- Bluetooth and IEEE802.11 are sometimes used simultaneously in mutually complementary use cases.
 - 1) Bluetooth is used for hands-free call while WLAN is used for internet connection
 - 2) Bluetooth is used for A2DP/HFP while WLAN is used for internet connection

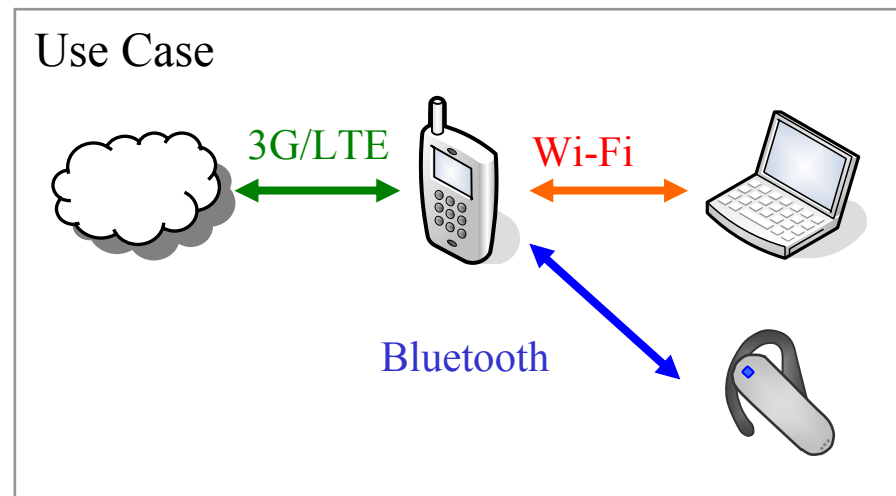

Related Work & Problem Statements

- The problem of coexistence and mutual interference between Bluetooth and WLAN has been well investigated.
- Coexistence mechanisms can be classified into two types according to their working principles:
 - ✓ Collaborative mechanisms : IEEE802.15.2, V-OLA etc
 - ✓ Non-collaborative mechanisms : Bluetooth AFH, etc

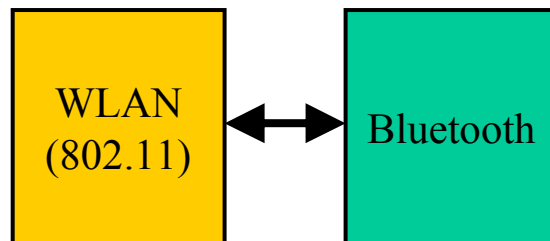

Collaborative

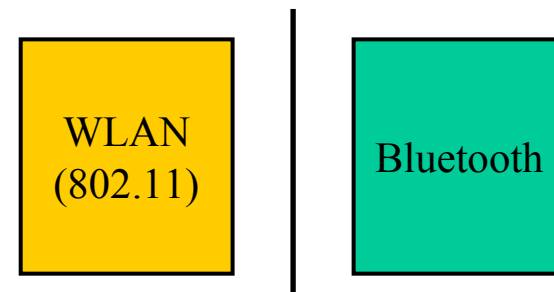

Non-collaborative

Legacy: Collaborative Mechanisms

IEEE802.15.2 Coexistence:

- IEEE802.15.2 slightly reduces the ratio of collision rate between Bluetooth and WLAN, but DOESN'T improve performance for Bluetooth and WLAN.
- This mechanism is unable to mitigate interference coming from non-located devices.
- In the case of “Transmit-Receive” collisions which one radio is transmitting and the other is receiving, 802.15.2 Coex is also unable to mitigate interference.
- Furthermore, since they completely alternate transmissions of technologies sharing the same radio spectrum, the system throughput must be significantly degraded.

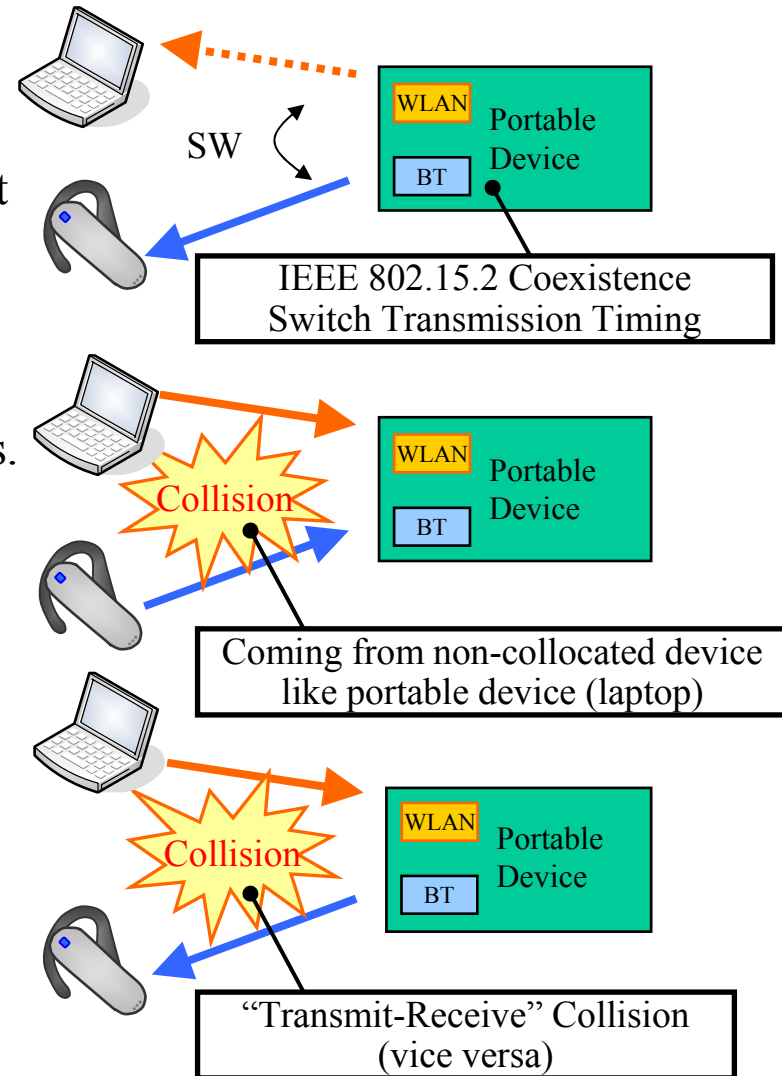

Legacy: Non-Collaborative mechanisms

Bluetooth AFH:

- Bluetooth AFH improves Bluetooth performance, but the existed devices such as WLAN remain interference because only the channel condition of Bluetooth is considered.
- Bluetooth uses adjacent channels of WLAN operation channel which caused interference for WLAN throughput and small packets error of Bluetooth.
- Furthermore, Bluetooth and WLAN are set up in close, WLAN transmission is controlled because WLAN detects Bluetooth by the carrier sense in adjacent channel.

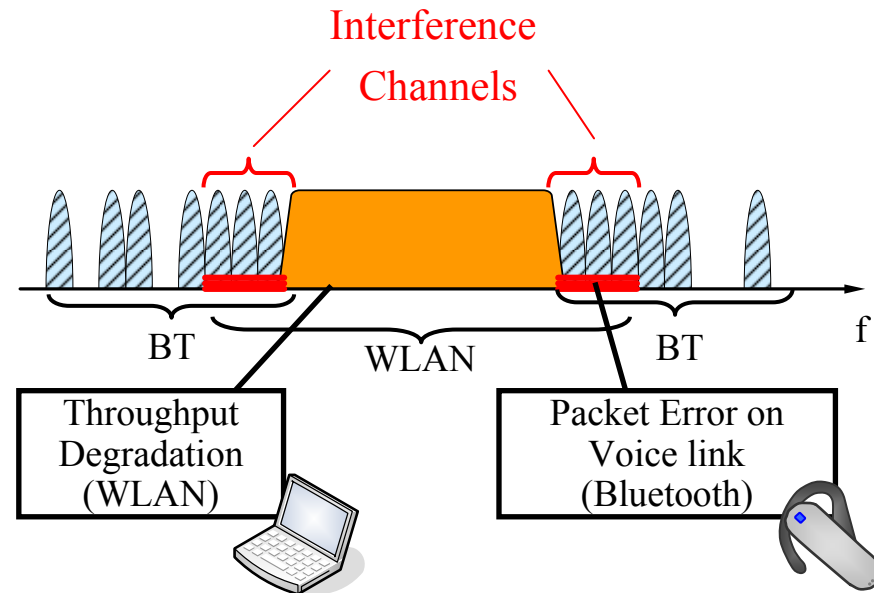

Summary of Problem Statements

- As the mutually complementary use cases of Bluetooth and WLAN became popular, it was found that these interference avoidance functions do not work effectively.
- In some former investigations, methods to improve the efficiency of the interference avoidance were proposed.
- These former investigations, however, cannot avoid a kind of interference:
 - ✓ Throughput degradation due to alternative transmission (IEEE802.15.2)
 - ✓ “Transmit-Receive” collisions which one radio is transmitting and the other is receiving (IEEE802.15.2)
 - ✓ False detection by WLAN carrier sense because the interference avoidance mechanism of AFH considers only the channel condition of Bluetooth (Bluetooth AFH)

Cooperative Channel Segmentation (CCS)

Our Basic Concept :

- Enhances the current AFH mechanisms to avoid frequency overlap channels between Bluetooth and WLAN in consideration of mutual interferences and the carrier sense detection of WLAN.
- Shares the mutual interference channel information and divides operation channels between Bluetooth and WLAN at Driver SW.
- The proposed algorithm can apply when Bluetooth and WLAN are able to exchange information on the same portable device.

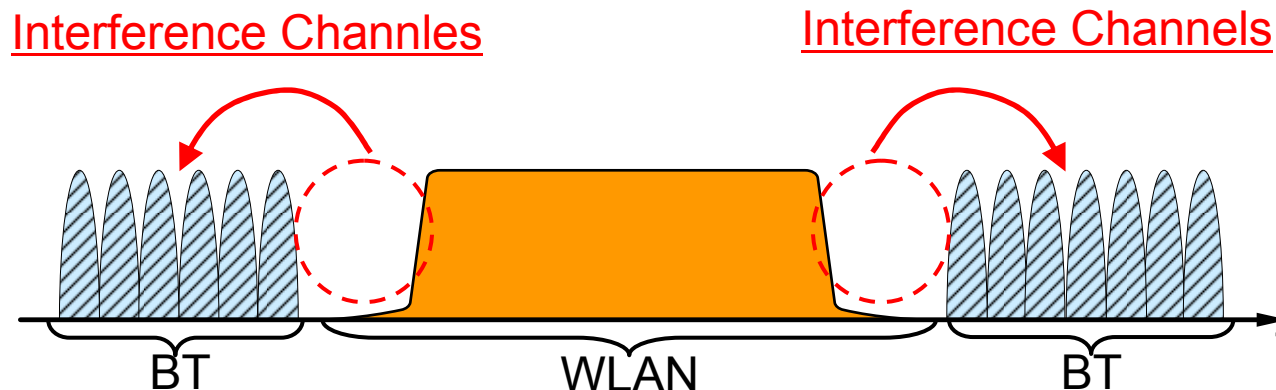

Cooperative Channel Segmentation (CCS)

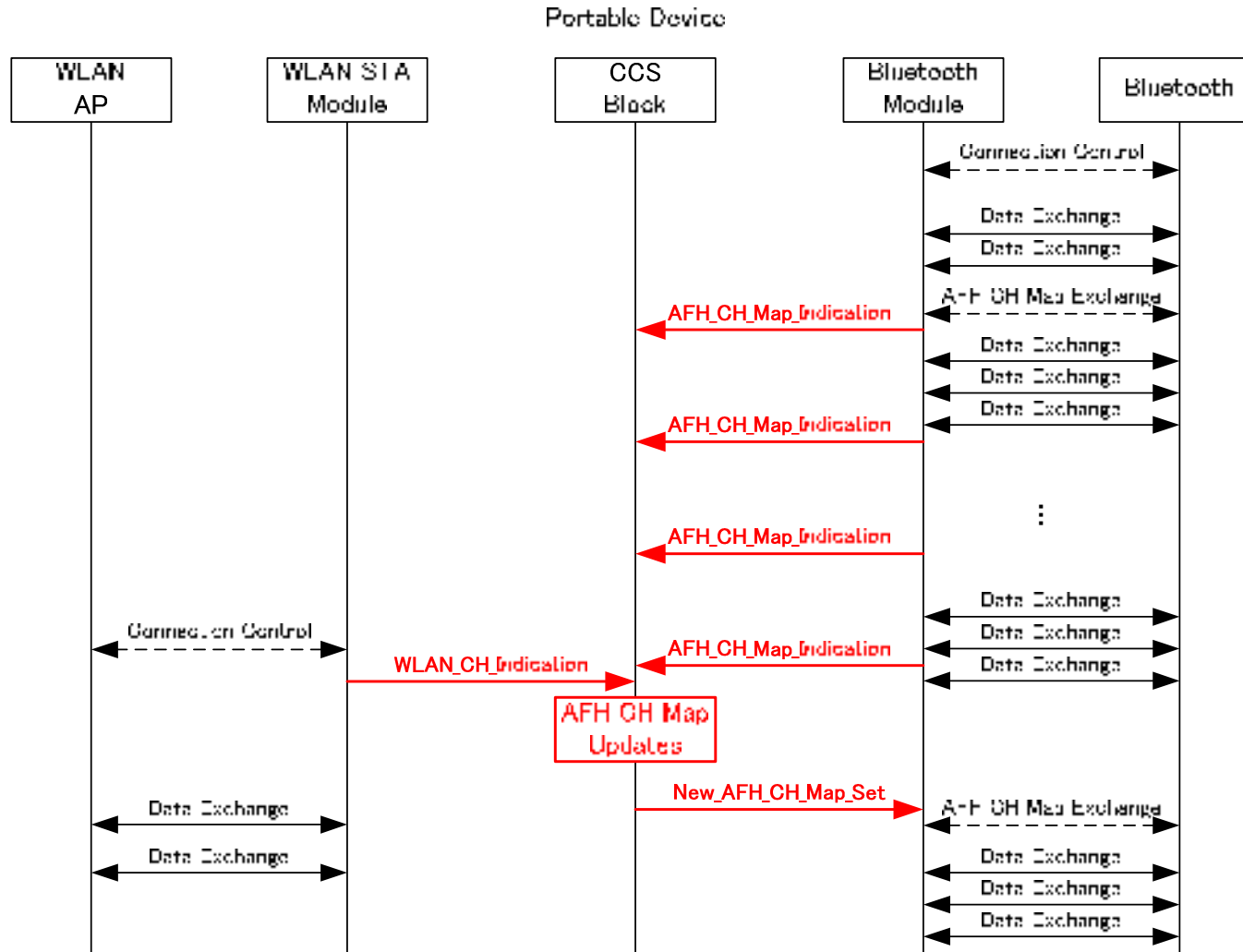

Overall structure of the proposed CCS mechanism

Simulation Conditions

WLAN (IEEE802.11b/g)	<ul style="list-style-type: none"> - Operational Channel : 7 ch ($f_c = 2442\text{MHz}$) - Data/ACK Transmission Rate: 54Mbps, 24Mbps - Transmission power : 10dBm/20MHz - Noise figure : 101dBm (114dBm/MHz) - Traffic: 1500 byte of UDP constant data (full buffer) - CTS-myself, - Beacon (Long Preamble)
Bluetooth (version 2.1)	<ul style="list-style-type: none"> - Transmission pattern : eSCO for voice (12 slots cycle) - Transmission power : 0dBm/MHz - Noise figure : 101dBm
Location (x, y) [m]	<ul style="list-style-type: none"> - Bluetooth Master (0, 0) / Slave (0, 0), WLAN AP/STA (0, 0) - Channel Model: Rayleigh Fading

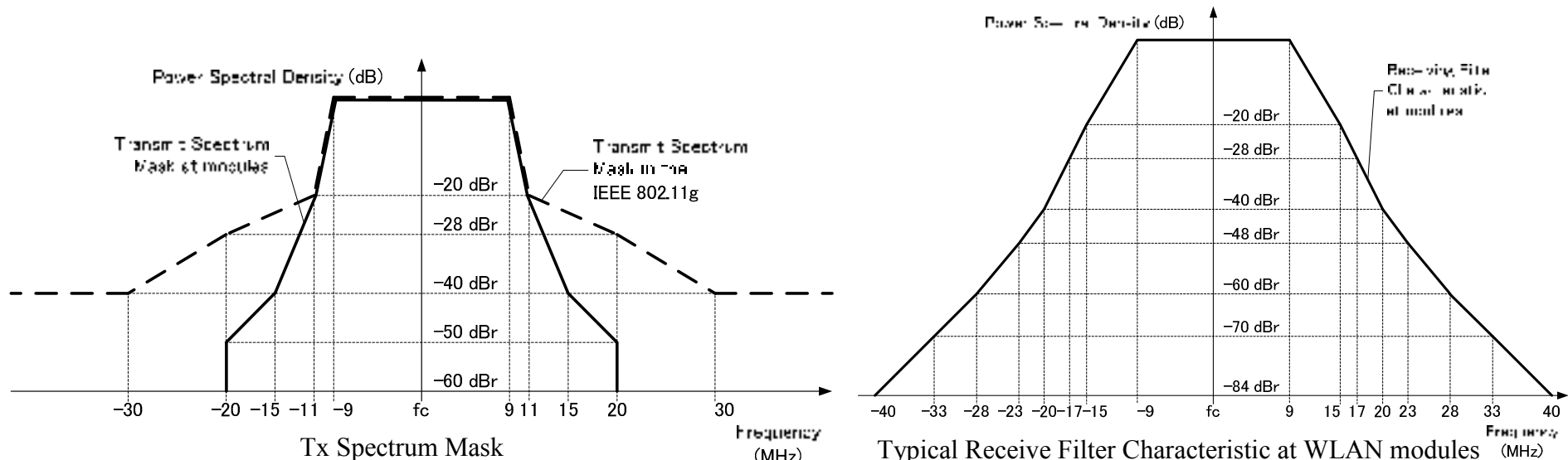

Simulation Results

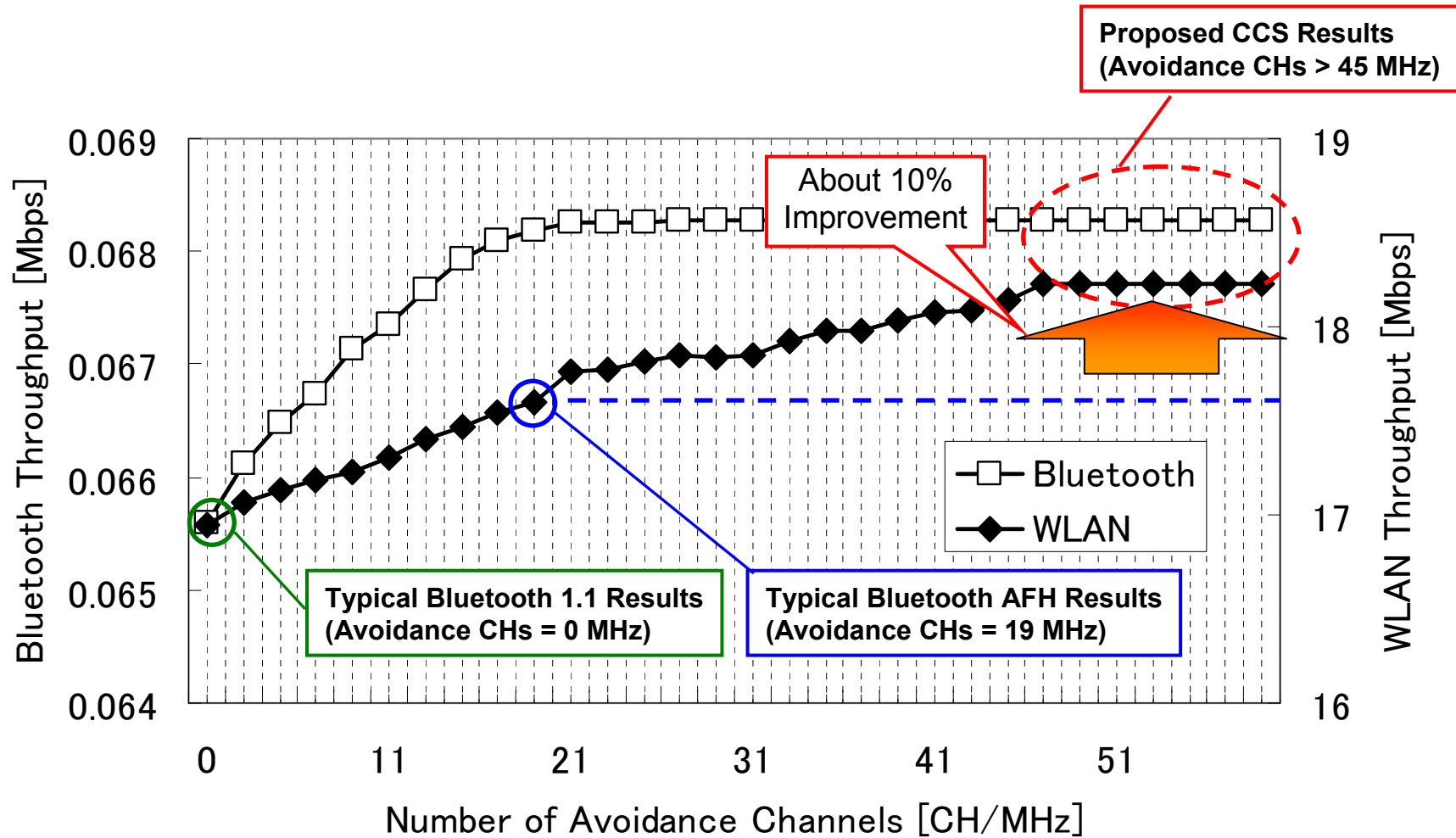

Conclusion & Future works

Conclusion:

- Propose the Cooperative Channel Segmentation (CCS) which mitigate mutual interference and improve throughput.
- Effectively avoids the false detection of WLAN carrier sense by considering pre-shared information of mutual interference channels.
- Results show over 10 % improvement for WLAN throughput against Legacy AFH, and achieve error free for Bluetooth caused by interference.
(250% improvement against IEEE802.15.2)

Work in progress and future works:

- Evaluations for other Bluetooth profile (A2DP, Wide-band Speech, etc)
- Evaluations in consideration with OBSS conditions, antenna correlation, WLAN/Bluetooth location.