

**Project: IEEE P802.15 Working Group for Wireless Personal Area Networks (WPANs)**

Submission Title: [MAC Proposals for low-power consumption]

Date Submitted: []

Source: [Fumihide Kojima<sup>1</sup>, Hiroshi Harada<sup>1</sup>, Takaaki Hatauchi<sup>2</sup>, Minoru Tanabe<sup>3</sup>, Kentaro Sakamoto<sup>4</sup>, Aiichiro Kashiwagi<sup>5</sup>, Takahiro Banno<sup>6</sup>, Hirohito Nishiyama<sup>7</sup>]

Company [1NICT, 2Fuji Electric, 3Panasonic, 4Tokyo Gas, 5Osaka Gas, 6Toho Gas, 7Mitsubishi Electric Corp.]

Address [13-4, Hikari-no-oka, Yokosuka-shi, Kanagawa239-0847, Japan]

Voice: [1+81-46-847-5074]

FAX: [1+81-46-847-5440]

E-Mail: [f-kojima@nict.go.jp, harada@nict.go.jp ]

Re: [In response to TG4g Call for Proposals]

Abstract: [Proposal of PHY and MAC for low-power consumption SUN]

Notice: This document has been prepared to assist the IEEE P802.15. It is offered as a basis for discussion and is not binding on the contributing individual(s) or organization(s). The material in this document is subject to change in form and content after further study. The contributor(s) reserve(s) the right to add, amend or withdraw material contained herein.

Release: The contributor acknowledges and accepts that this contribution becomes the property of IEEE and may be made publicly available by P802.15.

# Summary

- Confirmation of proposal on the following PHY and MAC
  - PHY: modification from 15.4 to support low-power multi-hop transmission for meter reading utility
    - 950MHz, 400MHz and lower frequency for simple single carrier transmission
    - 200kHz channel spacing assuming two carrier bundling to support 400kHz signal bandwidth
    - 50kbps(2GFSK), 100kbps(2GFSK), 200kbps(2GFSK; Option), 400kbps(4GFSK; Option)
    - No SS option
  - MAC: modification and addition of functions on the basis of 15.4MAC
    - Beacon-enabled PAN
      - Beacon turn off mode with active period
      - Intermittent hearing using CAP and receiving in the following inactive period
      - Tree topology with independent superframe determination
    - Nonbeacon-enabled PAN
      - Data req. command/procedure modification for data communication in the mesh topology

# System Concept

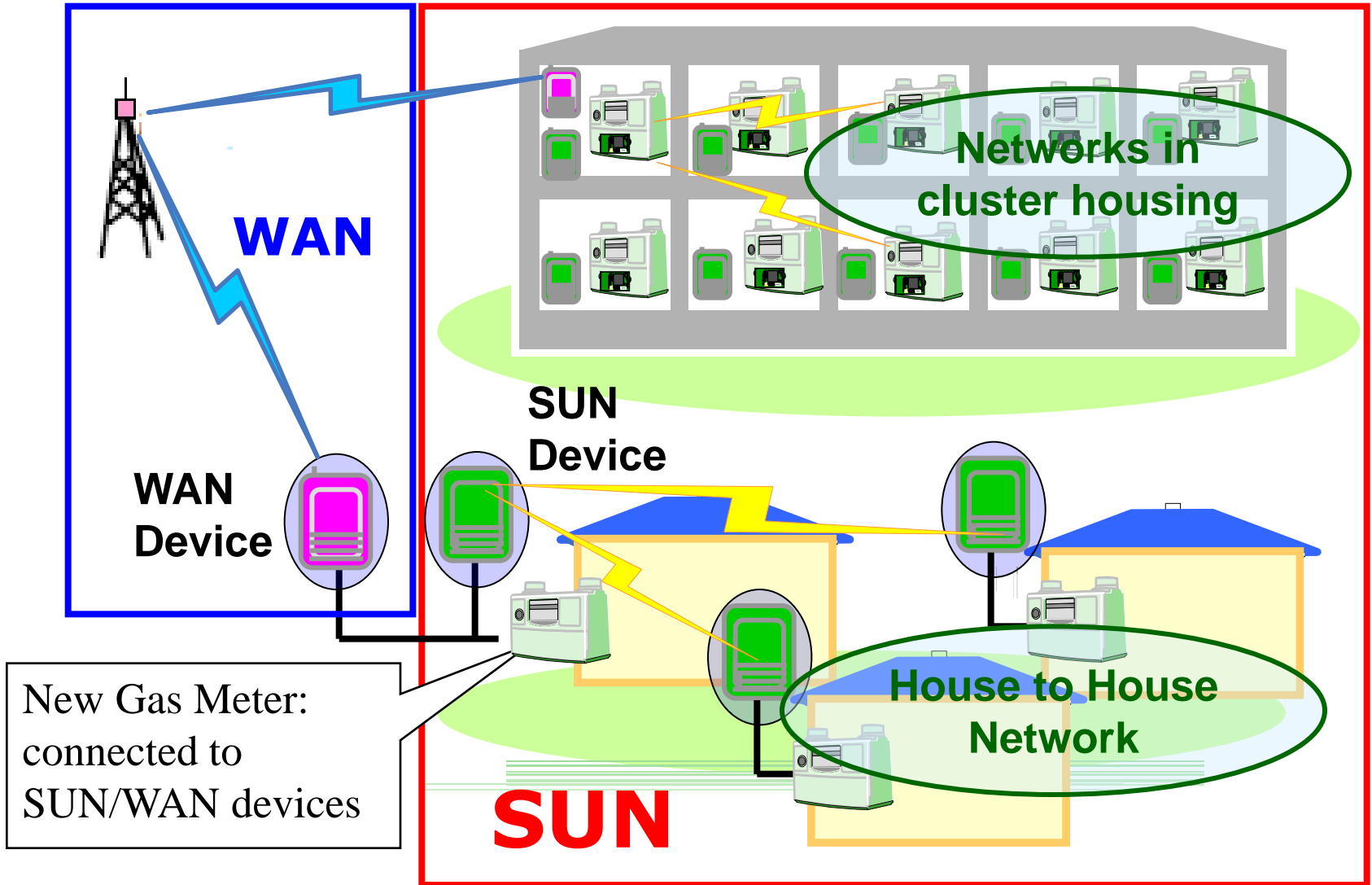

# System image of the assumed specified low power radio system

**Automatic meter** for gas, electricity and water is considered one of very attractive usage of specified low power radio on 400MHz band that realizes rational management and advanced customer services, while the following issues are considered before practice and diffusion.

Issues to be considered

- **Small transmission power restricts the service area**
- Advanced transmission scheme is required with coexistence with the other systems
- Battery lifetime is required to be improved for radio terminals

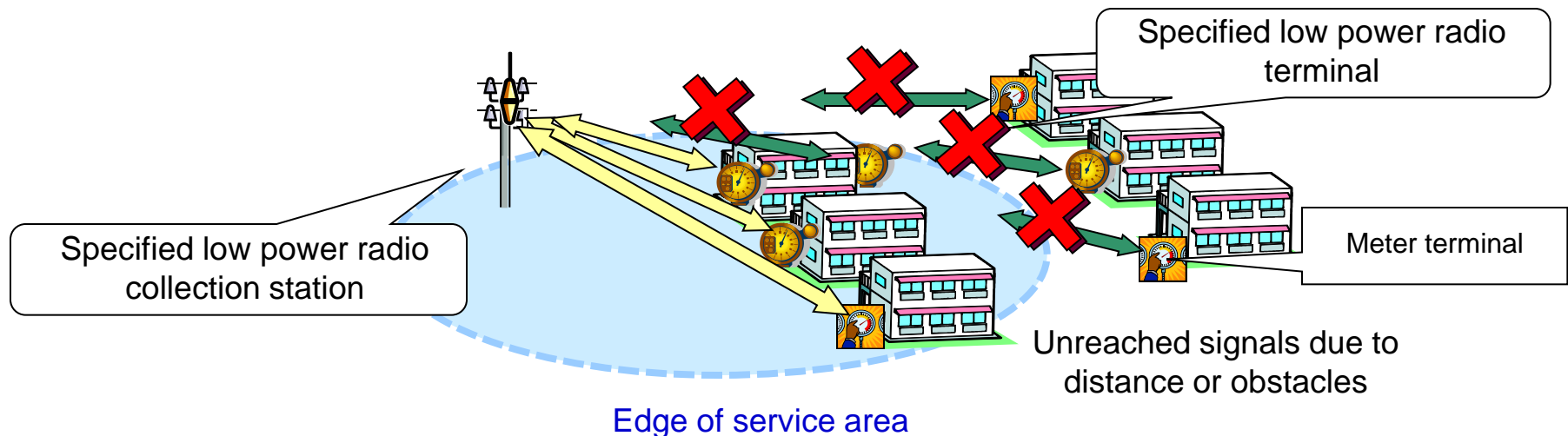

# Improvement by multi-hop transmission employment

Multi-hop transmission enables service area expansion by the following functions

- Signal range expansion
- Blind-spot reduction

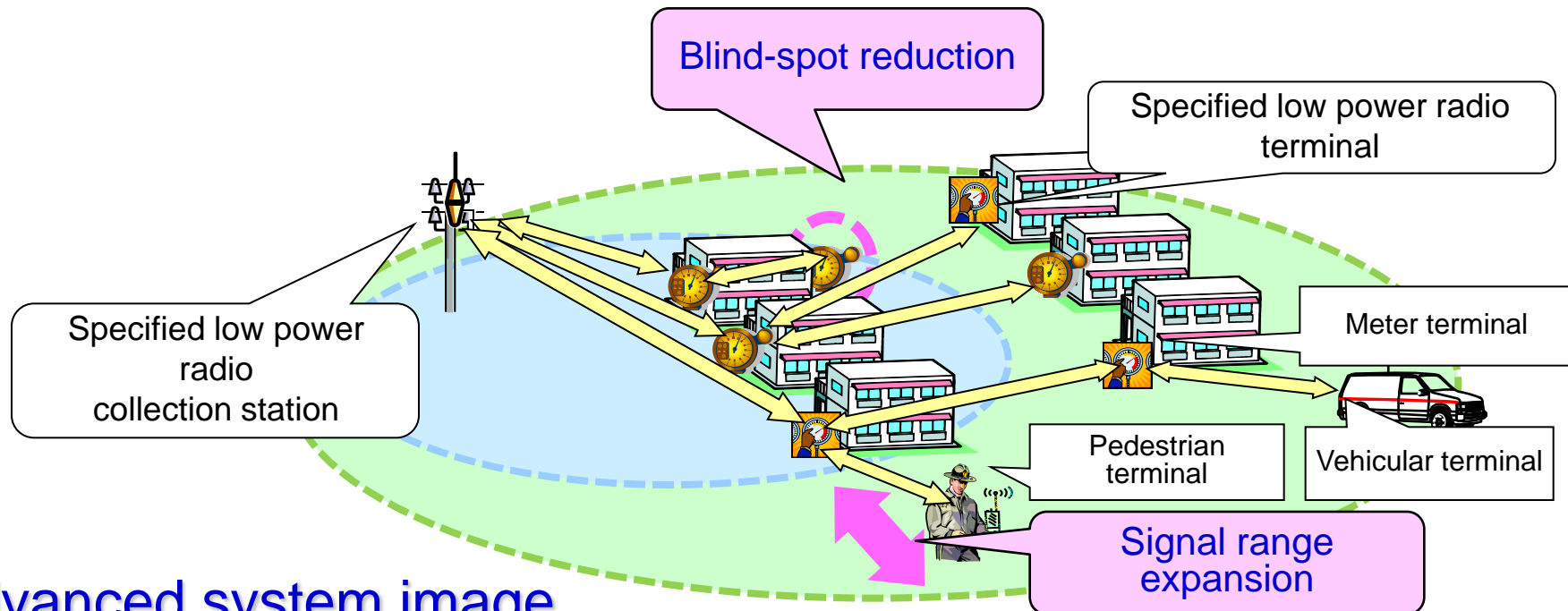

Advanced system image

# Our proposal

- PHY: modification from 15.4 to support low-power multi-hop transmission for meter reading utility
  - 400MHz and lower frequency band
  - Up to 300kHz bandwidth for simple single carrier transmission without complexity of higher level modulation such as 16QAM
- MAC: modification and addition of functions on the basis of 15.4MAC to cope with the modified PHY and multi-hop transmission
  - Beacon-enabled PAN
    - Beacon turn off mode with active period
    - Intermittent hearing using CAP and receiving in the following inactive period
    - Tree topology with independent superframe determination
  - Nonbeacon-enabled PAN
    - Data req. command/procedure modification for data communication in the mesh topology

# Summary of Proposed PHY and MAC

Center frequency band	950MHz, 400MHz and lower
Channel spacing	200kHz
Spread spectrum	Non-SS mode as optional case
Transmission power	Max 10dBm (antenna input power)
Modulation scheme	2GFSK, 4GFSK
FEC	TBD including Non-FEC mode
Signal bandwidth	100kHz– 400 kHz to support from 50kbps-2GFSK to 400kbps-4GFSK
Data rate (PHY SAP)	50kbps, 100kbps, 200kbps(Option), 400kbps(Option)
MAC scheme	CSMA/CA with sleeping period based on 15.4MAC
Routing scheme	Based on autonomous TREE topology construction
Transmission range	Up tp 150 m @ bandwidth of 150kHz

This proposal is decided on the basis of the following evaluation details of which are depicted in 09/0312r3

- Measurement of propagation characteristic
- Computer simulation
- Evaluation by experimental prototype
- Evaluation by pre-commercialized prototypes that achieve
  - 2.7Ah/3years performance: beacon-enabled PAN
  - 4.4Ah/10years performance: non-beacon enabled PAN (transmit/receive 2000 packets/year)

# PHY proposal

- PHY: modification from 15.4 to support low-power multi-hop transmission for meter reading utility
  - 950MHz, 400MHz and lower frequency for simple single carrier transmission
  - 200kHz channel spacing assuming two carrier bundling to support 400kHz signal bandwidth
  - 50kbps(2GFSK), 100kbps(2GFSK), 200kbps(2GFSK; Option), 400kbps(4GFSK; Option)
  - No SS option



# PHY parameters

- 400MHz band allocation
  - Channel spacing: 200kHz
  - Channel number: 4~5(w/o bundling), 3~4(w/ bundling)
  - Modulation: 2GFSK, 4GFSK
  - Data rate: 50kbps, 100kbps, 200kpbs, 400kbps
- 950MHz band allocation
  - Channel spacing: 200kHz
  - Channel number: 24(w/o bundling), 23(w/ bundling)
  - Modulation: 2GFSK, 4GFSK
  - Data rate: 50kbps, 100kbps, 200kpbs, 400kbps

# 400MHz band utilization

	Low	Mid (Default)	High1 (option 1)	High2 (option 2)
Data rate	50 kbps	100 kbps	200 kbps	400 kbps
Channel Spacing	200 kHz	200 kHz	200 kHz /w two carrier bundling (signal bandwidth is 400kHz)	200 kHz /w two carrier bundling (signal bandwidth is 400kHz)
Number of Channels	4~5	4~5	2(+1)~2(+2)	2(+1)~2(+2)
Modulation Technique	GFSK	GFSK	GFSK	4GFSK
Modulation Index	1.0 (+/- 25 kHz)	1.0 (+/-50 kHz)	1.0 (+/- 100 kHz)	TBD e.g. 50 kHz freq sep (-150, -50, +50, +150 kHz)
BT	0.5	0.5	0.5	0.5

- Japan allocation for the 15.4g on 400MHz:
  - **About 1MHz-system-bandwidth out of 400.0MHz~430.0MHz band** is under consideration that accommodates 5 of 200kHz spacing carriers
- Japan allocation for the conventional specified low power radio:
  - 426.0250 and 426.1375 MHz, 1mW (0dBm)
  - 429.1750 and 429.7375 MHz, 10mW (+10dBm)
  - 429.8125 and 429.9250 MHz, 10mW (+10dBm)
  - 449.7125 and 449.8875 MHz, 10mW (+10dBm)
  - 469.4375 and 469.4875 MHz, 10mW (+10dBm)

# Channel allocation on 400MHz

- 200kHz spacing assuming up to two carrier bundling that supports 400kHz signal bandwidth

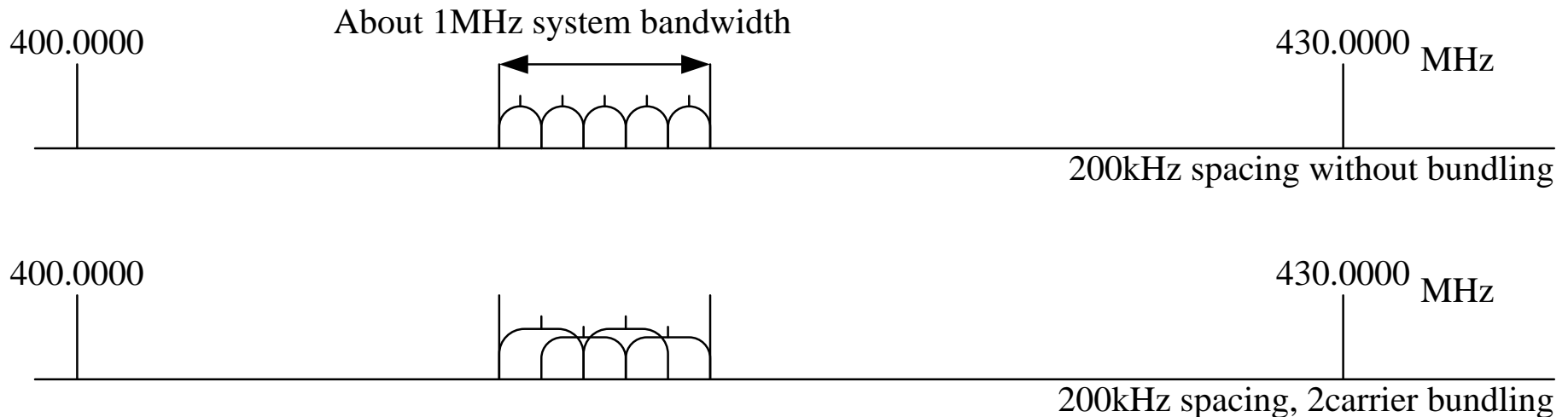

# 950MHz band utilization

	Low	Mid (Default)	High (option 1)	High (option 2)
Data rate	50 kbps	100 kbps	200 kbps	400 kbps
Channel Spacing	200 kHz	200 kHz	200 kHz /w two carrier bundling (signal bandwidth is 400kHz)	200 kHz /w two carrier bundling (signal bandwidth is 400kHz)
Number of Channels	24	24	12 (+11)	12 (+11)
Modulation Technique	GFSK	GFSK	GFSK	4GFSK
Modulation Index	1.0 (+/- 25 kHz)	1.0 (+/-50 kHz)	1.0 (+/- 100 kHz)	TBD e.g. 50 kHz freq sep (-150, -50, +50, +150 kHz)
BT	0.5	0.5	0.5	0.5

- Japan allocation that copes with the proposal
  - 950.9-955.7MHz

# Channel allocation on 950MHz

- 200kHz spacing assuming up to two carrier bundling that supports 400kHz signal bandwidth

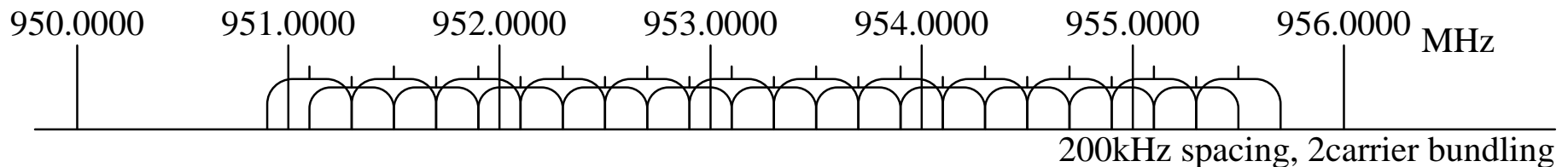
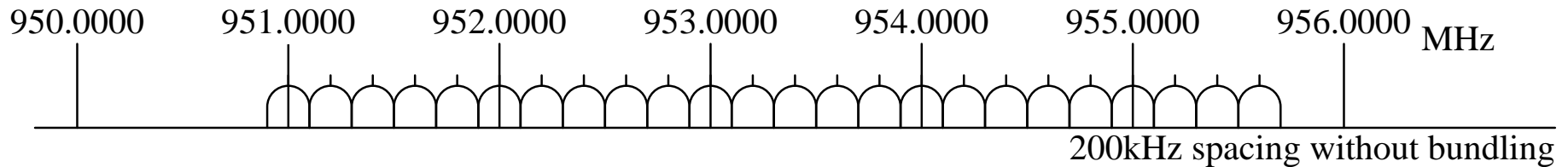

# Backup1: Japan allocation for specified low power radio on 400MHz

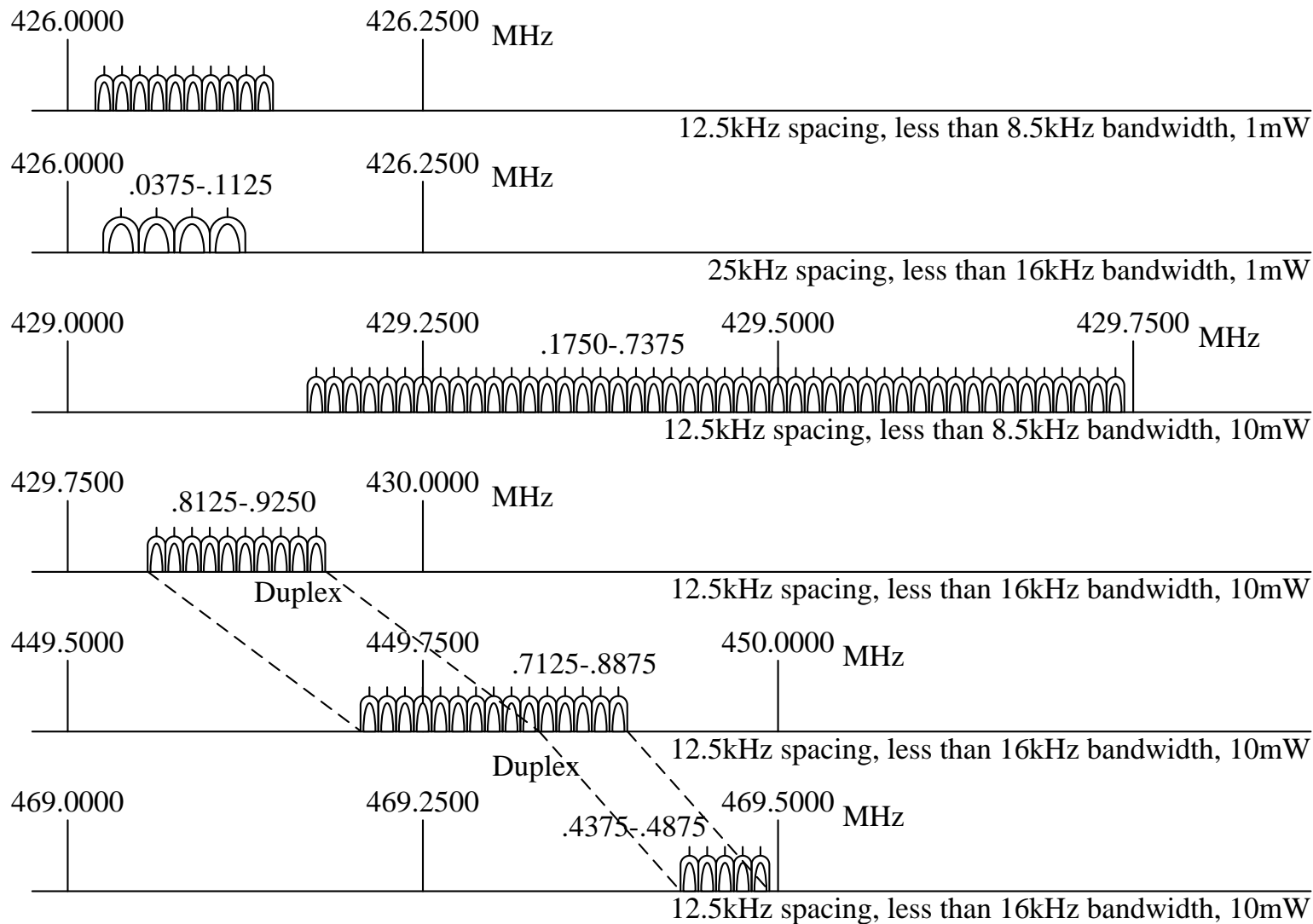

## Backup2: Japan allocation for specified low power radio on 950MHz

- 200kHz spacing assuming up to three bundling
- No signal bandwidth restriction
- Transmission power restriction of 10mW

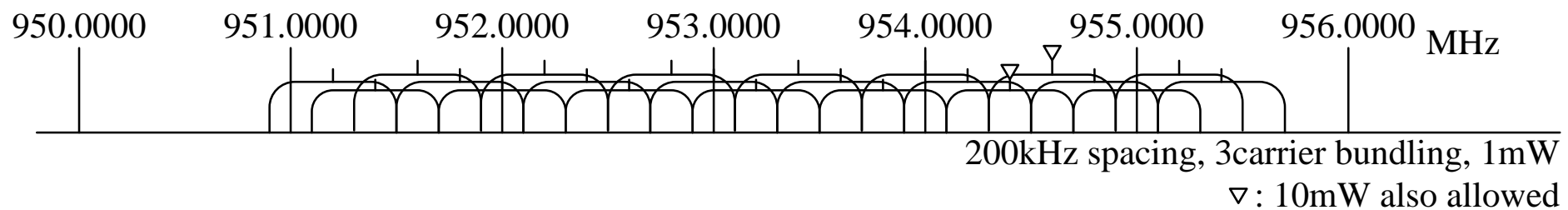
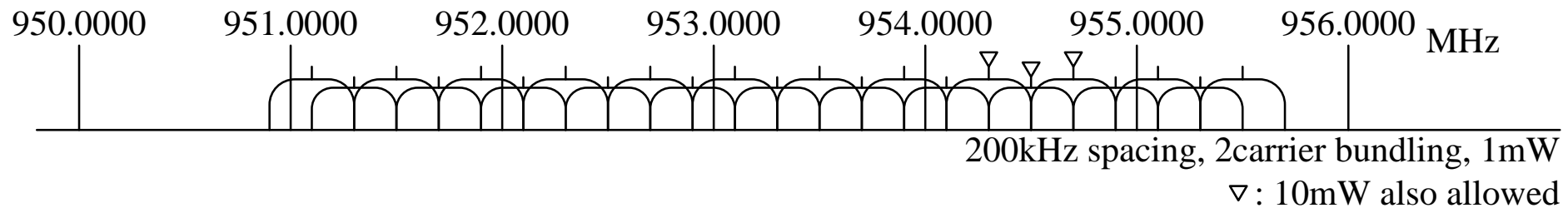
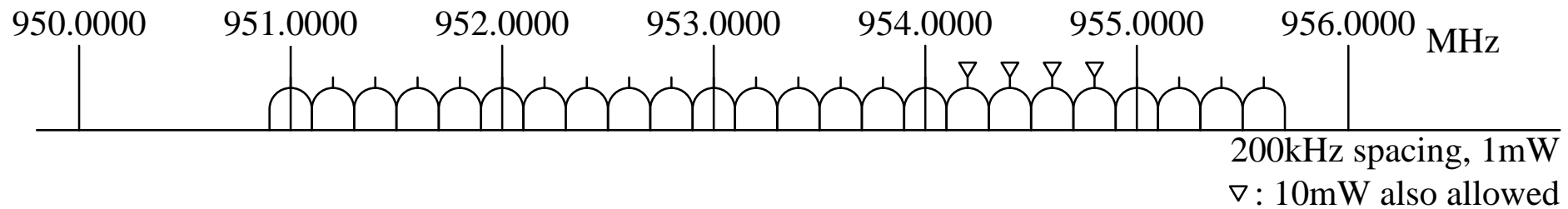

## Backup3: Allocation for 15.4d on 950MHz

- 200kHz spacing assuming up to three carrier bundling that supports 400kHz signal bandwidth

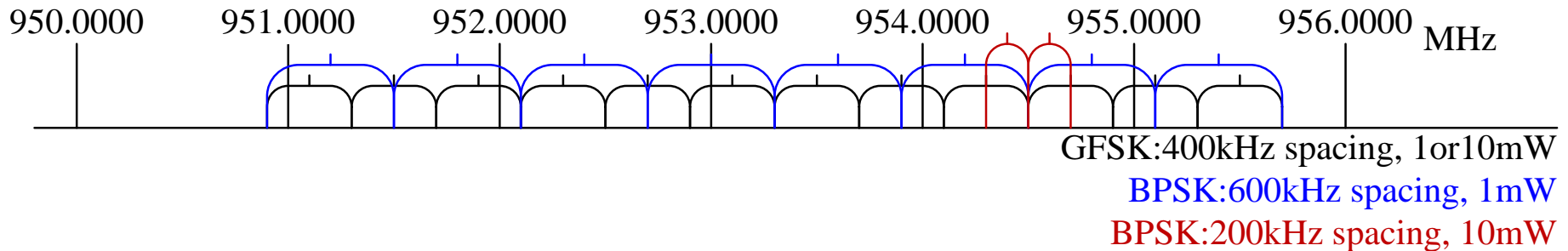



## Backup4: GFSK signals

- 50kbpsGFSK
- Frequency deviation: 25kHz
- BT:0.5
- Signal bandwidth: 82.3kHz

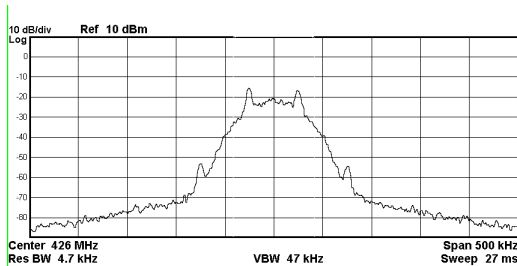

Occupied Bandwidth	82.2375 Hz		Total Power	-9.99 dBm
Transmit Freq Error	-224.8472 Hz	OBW Power	99.00 %	
x dB Bandwidth	105.884 Hz*	x dB	-26.00 dB	

- 100kbpsGFSK
- Frequency deviation: 50kHz
- BT:0.5
- Signal bandwidth: 166.3kHz

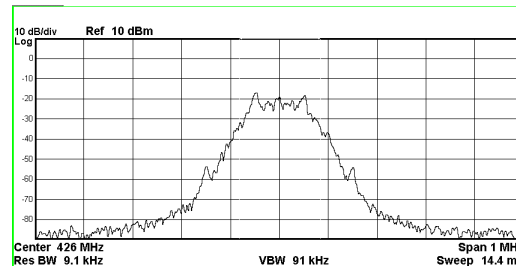

Occupied Bandwidth	166.2044 Hz		Total Power	-10.26 dBm
Transmit Freq Error	640.4327 Hz	OBW Power	99.00 %	
x dB Bandwidth	216.352 Hz*	x dB	-26.00 dB	

- 200kbpsGFSK
- Frequency deviation: 100kHz
- BT:0.5
- Signal bandwidth: 333.6kHz

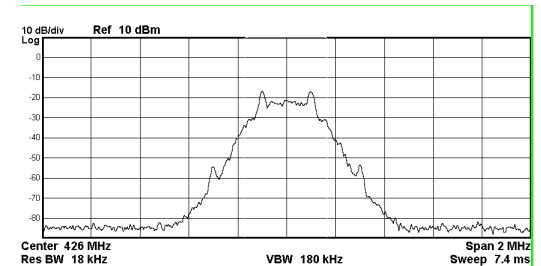

Occupied Bandwidth	333.5479 Hz		Total Power	-10.12 dBm
Transmit Freq Error	-1.5830 Hz	OBW Power	99.00 %	
x dB Bandwidth	432.278 Hz*	x dB	-26.00 dB	

# MAC proposal

- MAC: modification and addition of functions on the basis of 15.4MAC
  - Beacon-enabled PAN
    - Beacon turn off mode with active period
    - Intermittent hearing using CAP and receiving in the following inactive period
    - Tree topology with independent superframe determination
  - Nonbeacon-enabled PAN
    - Data req. command/procedure modification for data communication in the mesh topology

# MAC proposal

## - Beacon-enabled PAN

# MAC specification (1): topology

- Two types of devices as defined in 15.4MAC
  - FFD (Full function device) as collection station or meter that can determine superframe and accept association by other meters
  - RFD (Reduced function device) as meter
- After power-on
  - The collection station makes a PAN by determining PAN ID and superframe duration
  - A meter conducts active scan to find the collection station or meter that is FFD **connected to the collection station**, then tries to associate one of suitable FFD found
- After association
  - The associated FFD can return response to the active scan request by determining **outgoing superframe**
  - The associated FFD can further accept the association request by unassociated meters

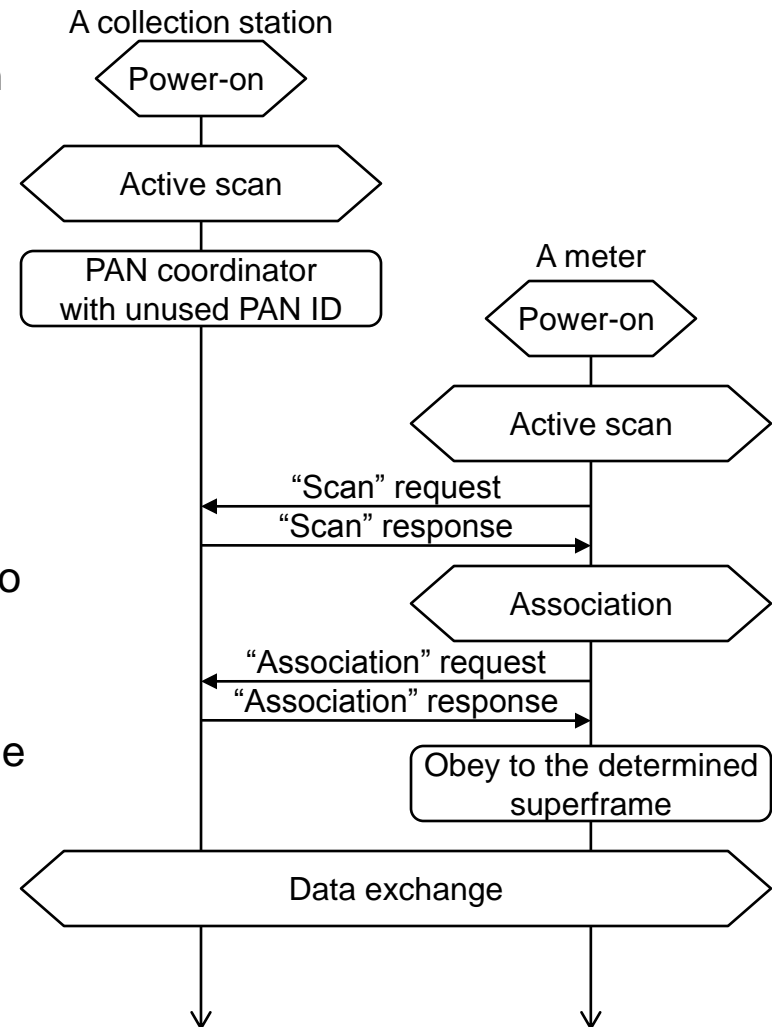

# MAC specification (2): superframe-1

Data receiving in the inactive period can improve low-power consumption performance

- FFD can determine superframe consists of an active period and an inactive period with/without a beacon
- Turned-off beacons with active period
  - Collection stations only send beacon after receiving “scan” request. In other period, the collection stations does not transmit any beacon:
- Intermittent hearing only in active period
  - Active period consists of only CAP
  - Data frame shall start in active period and end in the beacon interval. If data frame is sensed in CAP, the destination device continues receiving till the frame end

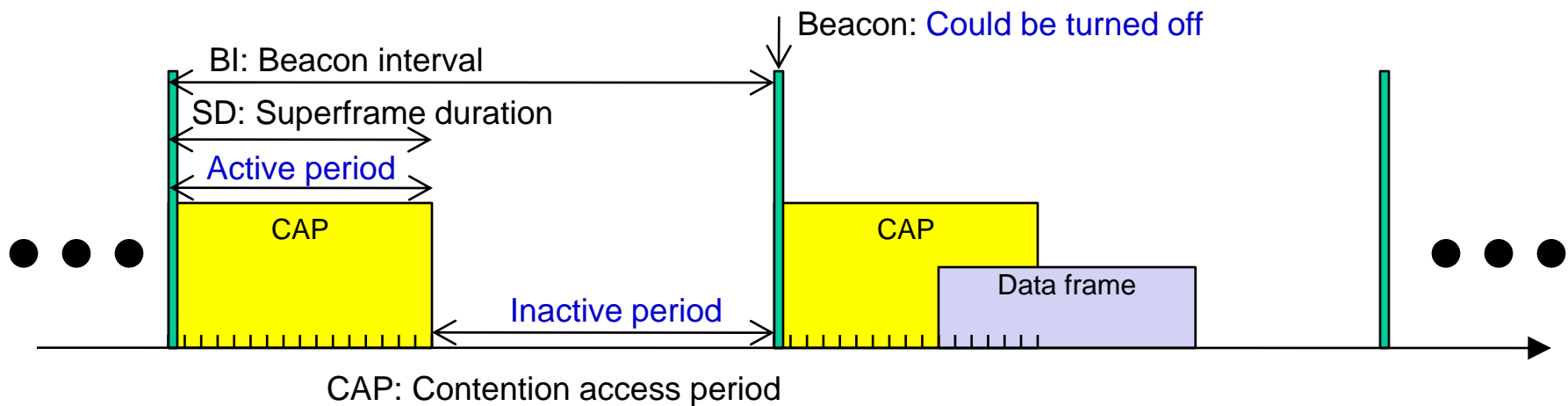

# MAC specification (2): superframe-2

Collection station and meters construct tree-shaped topology where each device determines superframe with turning off beacon. In the figure below, device M1 is handling both **incoming superframe** by CS and **outgoing superframe** by M1 itself in order to conduct successful data relaying in such tree topology.

- 15.4MAC defines **same BI and SD** shall be employed in both incoming and outgoing superframe
- Assuming cluster -tree topology, **different BI and SD** might be suitable for incoming and outgoing superframe

CS: Collection station (First PAN coordinator)  
 Mn: Meter n (Coordinator or device)

BI: Beacon interval, SD: Superframe duration

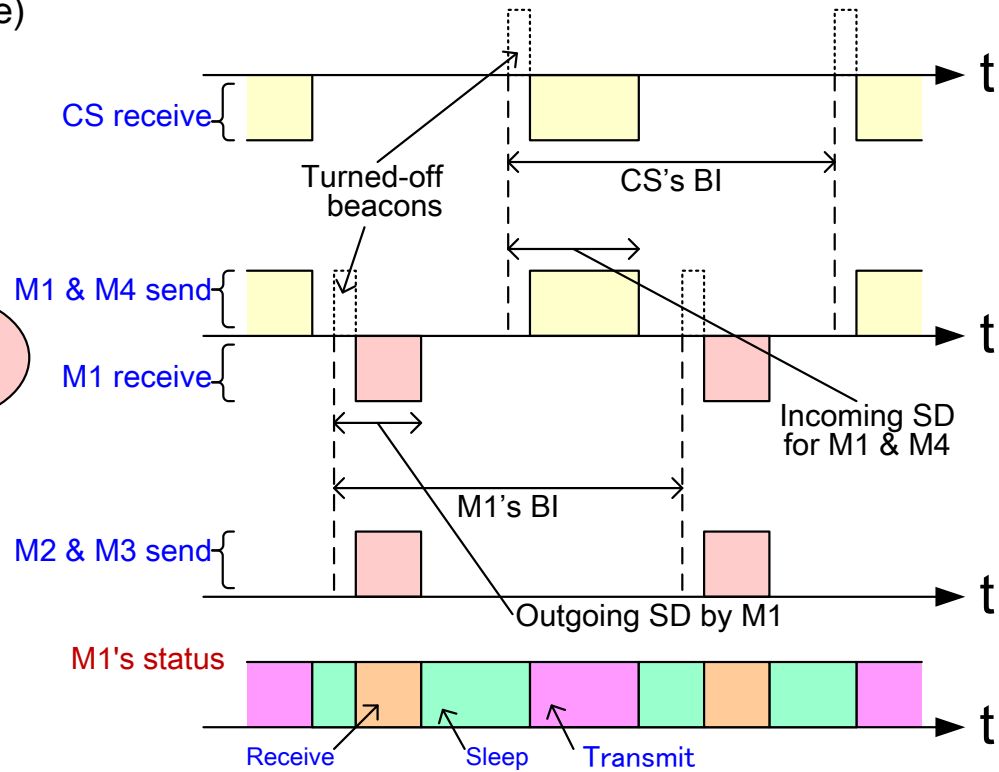
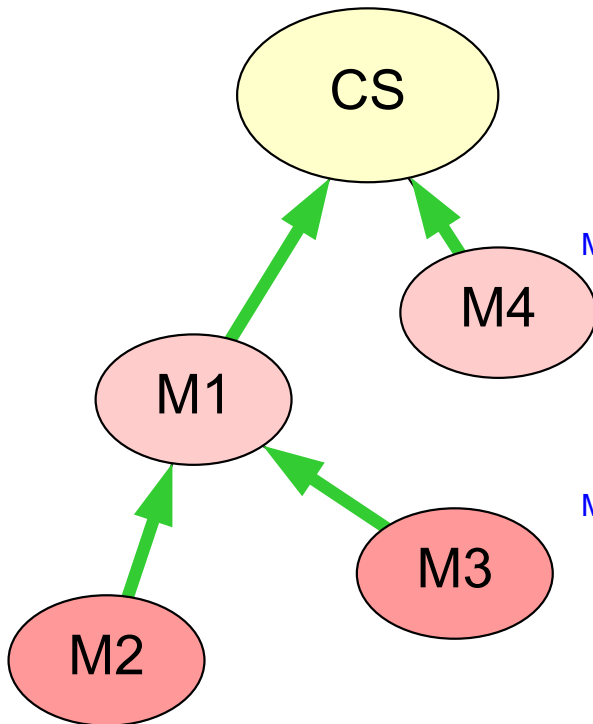

# MAC specification (3): frames

15.4 MAC frames are used with suitable modification

- Beacon frame: Might include superframe configuration information
- Command frames
  - Association req./res.
  - Disassociation notification
  - Data req.
  - PAN ID conflict notification
  - Orphan notification
  - Beacon request (for “scan” request)
  - Coordinator realignment: Might include superframe configuration information
  - GTS req.
- Data frame
- ACK frame

# MAC specification (4): functions

15.4MAC functions are used with suitable modification

- Channel access: **Needs to be modified**
  - Replies to the following type active scan need to include indications of low-power mode employment and independent superframe configuration
    - Active channel scan by beacon request command, replied by beacon
    - Orphan channel scan by orphan notification command, replied by coordinator realignment command
- Start and maintain PAN: : Needs to be modified
  - Beacon frame needs to include the superframe indications of low-power mode employment and independent superframe formation
- Association and disassociation
- Synchronization
- Transaction
- Transmission and reception
- (GTS(Guaranteed time slot) allocation)
- (Security)



## 15.4MAC advantage on multi-hop transmission for meter reading (Beacon-enable)

Assumed MAC can successfully provide multi-hop transmission as for meter reading utility by exploiting the following features

1. Autonomous topology construction by the association functions that can cope with situation of meter addition and removal
2. Autonomous data collection based on the tree topology
3. Sleeping period employment according to the inactive period configuration in each superframe

# MAC proposal

## - Non-beacon enabled PAN

# MAC specification (Nonbeacon-1): topology

- FFD devices as defined in 15.4MAC
  - FFD as both collection station and meter that can accept association without superframe
- After power-on
  - The collection station makes a PAN by determining PAN ID denoting nonbeacon-enabled PAN
  - A meter conducts active scan to find the collection station or meter that is FFD connected to the collection station, then tries to associate one of suitable FFD found
- After association
  - The associated FFD can return response to the active scan request without superframe
  - The associated FFD can further accept the association request by unassociated meters

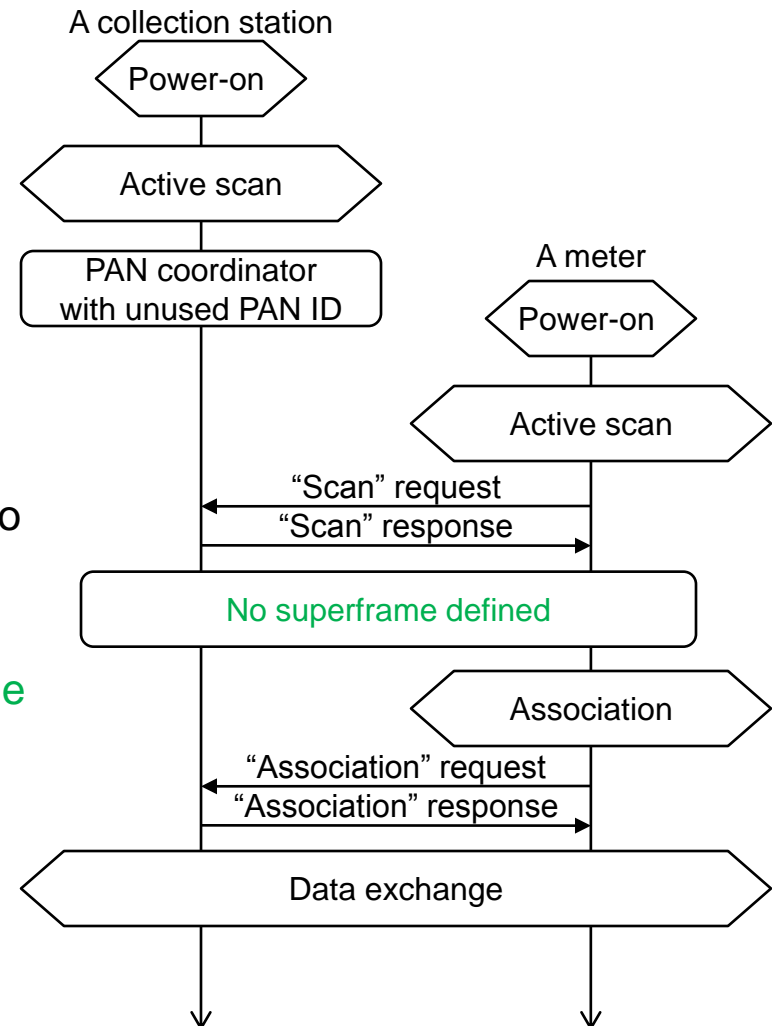

## MAC specification (Nonbeacon-2): superframe

- No superframe is defined

# MAC specification (Nonbeacon-2): channel access

- Based on “Receiver-Initiated CyclEd Receiver” scheme
  - En-Yi A. Lin, et al, “Receiver Initiated Rendezvous Schemes for Sensor Networks”, IEEE Globecom 2005
  - Well-suited for low duty cycle, intermittent operation with relatively low traffic

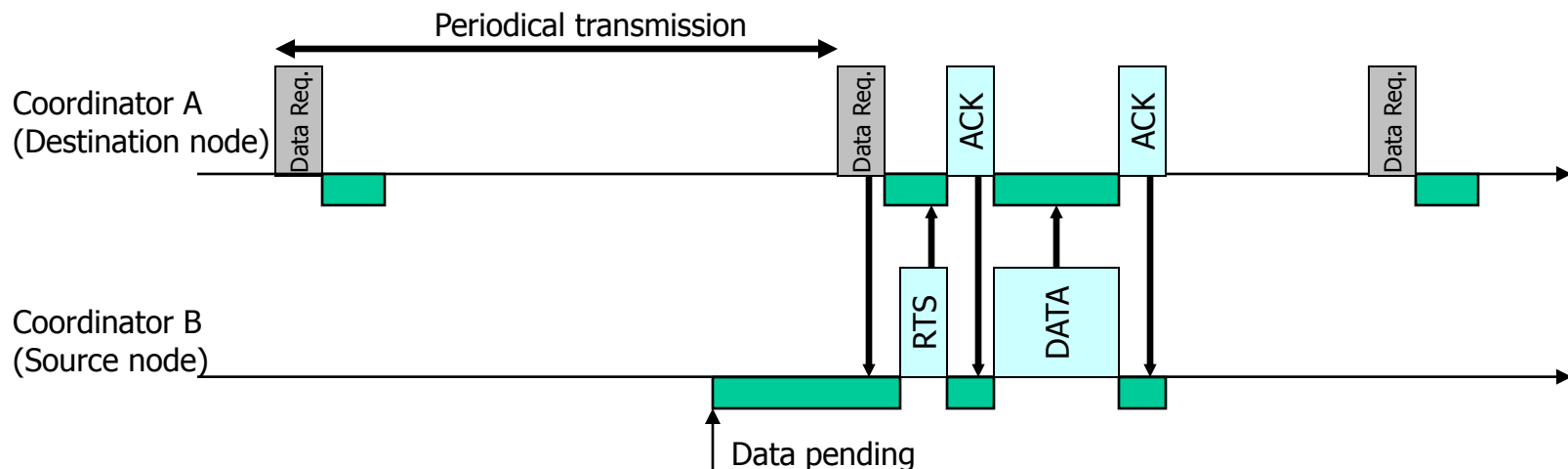

- All nodes periodically wake up, transmit Data Request command, go into receive mode for a short period of time and go back to sleep, asynchronously
- When the transmission request is generated from higher layer, it enables the receiver and waits for Data Request command from the destination device
- Upon reception of a Data Request command, the source node establishes a link with the destination node and transmits Data

# MAC specification (Nonbeacon-3): data transfer

- Modification from the current non-beacon enabled PAN
  - Addition of “Request-to-Send” command in reply to Data Request
    - ACK is required before Data frame to be transmitted
    - Better support of the Receiver initiated scheme

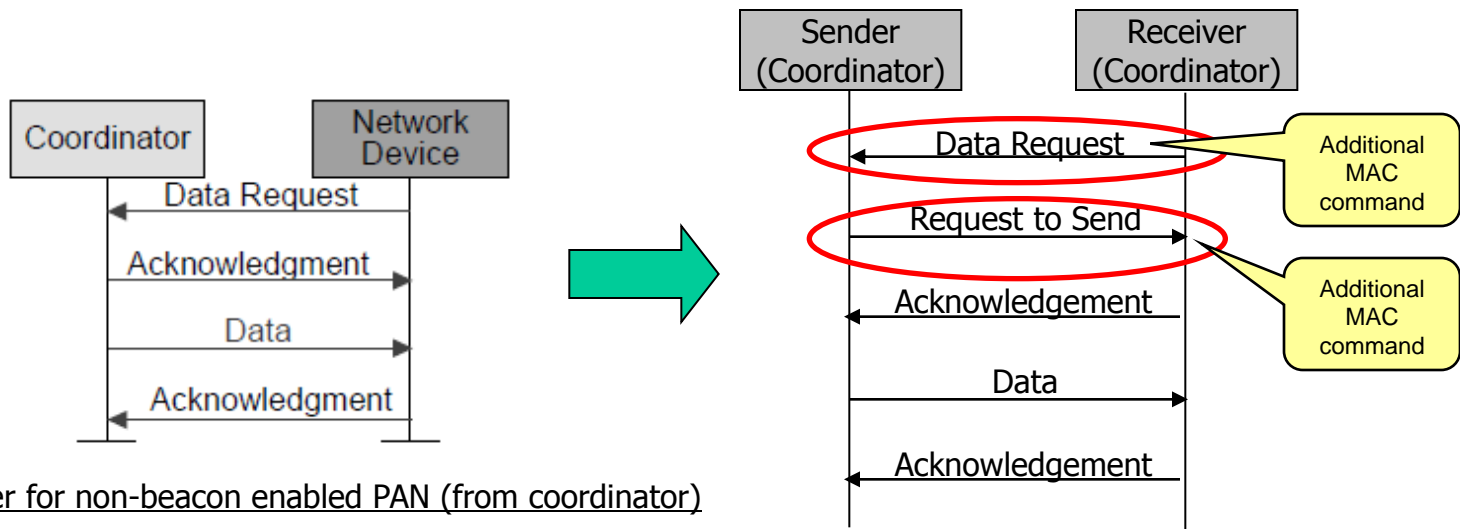

Data transfer for non-beacon enabled PAN (from coordinator)

# MAC specification (Nonbeacon-4): frames

15.4 MAC frames are used with suitable modification in Data req. command frame

- Beacon frame
- Command frames
  - Association req./res.
  - Diassociation notification
  - Data req.: used for data transmission in the mesh topology
  - PAN ID conflict notification
  - Orphan notification
  - Beacon request (for “scan” request)
  - Coordinator realignment
  - GTS req.
  - Request to send (RTS): used for data transmission in the mesh topology
- Data frame
- ACK frame: modification for better support of the Receiver initiated scheme

# MAC specification (Nonbeacon-5): functions

## 15.4MAC functions are used with suitable modification

- Channel access
- Start and maintain PAN
- Association and disassociation
- Synchronization
- Transaction
- Transmission and reception: supports data exchange in the mesh topology
- (GTS(Guaranteed time slot) allocation)
- (Security)



## 15.4MAC advantage on multi-hop transmission for meter reading (non-beacon enabled)

Assumed MAC can successfully provide multi-hop transmission as for meter reading utility by exploiting the suitable routing algorithm on the upper layer controls as following

- Tree-topology
- AODV
- Other routing algorithm

# General frame format

# Previous version of PPDU format

- For both beacon-enabled and nonbeacon-enabled PAN case, 15.4MAC general frame format could be used with a little modifications

## 15.4MAC

Variable	2	1	2	1	4~20	0/5/6/10/14	n	2
SHR		PHR	PSDU					
			MHR				MAC payload	MFR
preamble	SFD	Frame length	Frame control	Sequence #	Addressing field	Auxiliary security hr.	Data payload	FCS

## Proposal: Beacon-enabled

Variable	1	1	2	n	2	
SHR		PHR	PSDU (0~127)			
			MHR		MAC payload	MFR
preamble	Frame length	Frame ctrl.	Addressing field (includes TX and RX IDs)		Data payload	FCS

## Proposal: Nonbeacon-enabled

Variable	2	1	1	1	2	3	7	n	2
SHR		PHR	PSDU (127)						
			MHR					MAC payload	MFR
preamble	SFD	Frame length	Sequence #	Frame control	Addressing field (So, Di)	Network number	Data payload	FCS	

# Merged PPDU format

- The following modifications are added in the previous version
  - Support up to 1500octet PSDU
  - PHR2 addition that provide additional information such as diversity parameters
  - Network ID
  - FCS enhancement
- Format modifications to support further amendment are acceptable

## 15.4MAC

Variable	2	1	2	1	4~20	0/5/6/10/14	n	2
SHR		PHR	PSDU					
preamble			MHR				MAC payload	MFR
SFD	Frame length	Frame control	Sequence #	Addressing field	Auxiliary security hr.	Data payload	FCS	

## Proposal

Variable	2	2	1	1	1	1	2	n	4
SHR		PHR1	PHR2	Network ID	PSDU (~1500)				
preamble		MHR		MAC payload	MFR				
SFD	Frame length + ~	Additional infomation	ID	Sequence #	Frame control	Addressing field (So, Di)	Data payload	FCS	

# Conclusions

- Confirmation of proposal on the following PHY and MAC
  - PHY: modification from 15.4 to support low-power multi-hop transmission for meter reading utility
    - 950MHz, 400MHz and lower frequency for simple single carrier transmission
    - 200kHz channel spacing assuming two carrier bundling to support 400kHz signal bandwidth
    - 50kbps(2GFSK), 100kbps(2GFSK), 200kbps(2GFSK; Option), 400kbps(4GFSK; Option)
    - No SS option
  - MAC: modification and addition of functions on the basis of 15.4MAC
    - Beacon-enabled PAN
      - Beacon turn off mode with active period
      - Intermittent hearing using CAP and receiving in the following inactive period
      - Tree topology with independent superframe determination
    - Nonbeacon-enabled PAN
      - Data req. command/procedure modification for data communication in the mesh topology