

# IEEE P802.15

## Wireless Personal Area Networks

---

Project	IEEE P802.15 Working Group for Wireless Personal Area Networks (WPANs)
---------	------------------------------------------------------------------------

---

Title	Proposed Multi-Rate PHY Specification for Smart Utility Networks (SUN) submitted to IEEE 802.15.4g, utilizing the European 863-870 MHz Band
-------	---------------------------------------------------------------------------------------------------------------------------------------------

---

Date Submitted	July 15, 2009
----------------	---------------

---

Source	Michael Schmidt E-mail: michael.schmidt@atmel.com Dietmar Eggert E-mail: dietmar.eggert@atmel.com Frank Poegel E-mail: frank.poegel@atmel.com Torsten Bacher E-mail: torsten.bacher@atmel.com Sascha Beyer E-mail: sascha.beyer@atmel.com
--------	-------------------------------------------------------------------------------------------------------------------------------------------------------------------------------------------------------------------------------------------------------

---

Re	
----	--

---

Abstract	A detailed proposal for a Multi-Rate PHY for IEEE 802.15.4g for application in the European 863-870 MHz band
----------	--------------------------------------------------------------------------------------------------------------

---

Purpose	Technical proposal
---------	--------------------

---

Notice	This document has been prepared to assist the IEEE P802.15. It is offered as a basis for discussion and is not binding on the contributing individual(s) or organization(s). The material in this document is subject to change in form and content after further study. The contributor(s) reserve(s) the right to add, amend or withdraw material contained herein.
--------	-----------------------------------------------------------------------------------------------------------------------------------------------------------------------------------------------------------------------------------------------------------------------------------------------------------------------------------------------------------------------

---

Release	The contributor acknowledges and accepts that this contribution becomes the property of IEEE and may be made publicly available by P802.15.
---------	---------------------------------------------------------------------------------------------------------------------------------------------

---

# Proposed Multi-Rate PHY Specification for Smart Utility Networks (SUN) submitted to IEEE 802.15.4g, utilizing the European 863-870 MHz Band

July 15, 2009

## Contents

<b>1</b>	<b>PHY Specifications</b>	<b>4</b>
1.1	Operating frequency range . . . . .	4
1.2	Data rates . . . . .	4
1.3	Modulation and coding . . . . .	4
1.4	Reference modulator diagram . . . . .	4
1.5	Bit-to-symbol mapping . . . . .	5
1.6	Symbol-to-code word mapping . . . . .	5
1.6.1	C(32,4) coding . . . . .	5
1.6.2	C(16,4) coding . . . . .	6
1.6.3	C(8,4) coding . . . . .	7
1.6.4	C(4,4) coding . . . . .	8
1.7	Generation of the chip sequence . . . . .	9
1.8	GMSK modulation . . . . .	10
1.9	Channel numbering . . . . .	10
1.10	Radio specifications . . . . .	11
1.10.1	Clock offset tolerance . . . . .	11
1.10.2	Receiver sensitivity . . . . .	11
1.10.3	Adjacent channel rejection . . . . .	11
1.11	PPDU format . . . . .	12
1.11.1	Preamble field . . . . .	12

1.11.2	SFD field . . . . .	12
1.11.3	PHR field . . . . .	12
1.11.4	PSDU . . . . .	13
<b>2</b>	<b>Appendix</b>	<b>14</b>
2.1	European regularity requirements for the 863-870 MHz band . . . . .	14
2.2	Coding for GMSK . . . . .	16
2.3	SHR and PHR field . . . . .	18
2.4	Spectral properties . . . . .	19
2.5	I/Q imbalance . . . . .	20
2.6	Simulation results . . . . .	21

## Abstract

The purpose of this document is to provide the specifications for application in the 863-870 MHz band. This proposal is to be submitted to the Smart Utility Networks (IEEE 802.15.4g) Task Group for consideration in the PHY Amendment specification. The document is structured to follow the existing IEEE 802.15.4 standard. The term PHY in this document refers to this proposed PHY.

## 1 PHY Specifications

### 1.1 Operating frequency range

This PHY is intended to conform with established regulations in Europe, utilizing the frequency band of 863-870 MHz. The regulatory documents listed below are for information only and are subject to change and revisions at any time. Devices conforming to this PHY shall also comply with specific national restrictions, see [1] Annex 1 BAND-G.

- ERC Recommendation 70-03 [1]
- Draft ETSI EN 300-220-1, European Telecommunications Standards Institute (ETSI) [2]

### 1.2 Data rates

The supported data rates of this PHY shall be 25, 50, 100 and 200 kbit/s. Data rates 25 and 50 kbit/s are mandatory.

### 1.3 Modulation and coding

The PHY shall employ Gaussian Minimum Shift Keying (GMSK) with low complexity forward error-correcting block codes. The input sequence fed to GMSK modulator, called the *chip sequence*, shall be transmitted at constant rate of 200 kchip/s. Different data rates are supported by different code lengths of the corresponding block codes.

### 1.4 Reference modulator diagram

The functional block diagram in Figure 1 is provided as a reference for specifying the PHY modulation and coding functions. The number in each block refers to the sub-clause that describes that function.

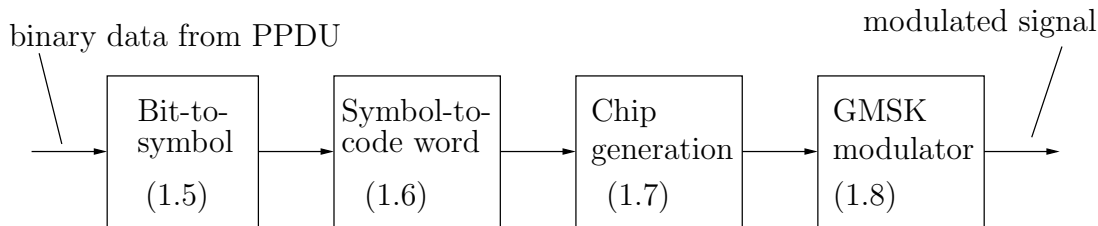

Figure 1: Reference modulator diagram.

## 1.5 Bit-to-symbol mapping

All binary data contained in the PPDU are encoded using the block codes as described in 1.6. This sub-clause describes how binary information is mapped into 4-tuples called symbols. The 4 LSBs ( $b_0, b_1, b_2, b_3$ ) of each octet shall map into one symbol, and the 4 MSBs ( $b_4, b_5, b_6, b_7$ ) of each octet shall map into the next symbol. Each octet of the PPDU is processed sequentially, beginning with the preamble field and ending with the last octet of the PSDU. Within each octet, the least significant symbol ( $b_0, b_1, b_2, b_3$ ) is processed first and the most significant symbol ( $b_4, b_5, b_6, b_7$ ) is processed second.

## 1.6 Symbol-to-code word mapping

Block codes of different code lengths are used in order to support multiple data rates. Tables 2 to 5 show the mapping of a symbol to a specific code word. Table 1 shows the supported codes and corresponding data rates.

<i>DataRateMode</i>	block code	code rate	data rate [kbit/s]	remark
1	C(32,4)	1/8	25	mandatory
2	C(16,4)	1/4	50	mandatory
3	C(8,4)	1/2	100	optional
4	C(4,4)	1	200	uncoded, optional

Table 1: Supported data rates.

### 1.6.1 C(32,4) coding

This code obtains code words of length  $N_1 = 32$ . Rate 1/8 coding according to Table 2 shall be applied for encoding the SHR and PHR.

The same coding shall be used for encoding the PSDU part of the frame, when *DataRateMode* is set to 1, leading to a PSDU data rate of 25 kbit/s.

symbol ( $b_0, \dots, b_3$ )	code word ( $c_0, \dots, c_{31}$ )
0000	01101001000010101110110001111100
1000	11000110100100001010111011000111
0100	01111100011010010000101011101100
1100	11000111110001101001000010101110
0010	11101100011111000110100100001010
1010	10101110110001111100011010010000
0110	00001010111011000111110001101001
1110	10010000101011101100011111000110
0001	10010110111101010001001110000011
1001	00111001011011110101000100111000
0101	100000111001011011111010100010011
1101	001110000011100101101111101010001
0011	00010011100000111001011011110101
1011	01010001001110000011100101101111
0111	11110101000100111000001110010110
1111	01101111010100010011100000111001

Table 2: C(32,4) coding.

### 1.6.2 C(16,4) coding

This code obtains code words of length  $N_2 = 16$ . Rate 1/4 coding shall be used for encoding the PSDU part of the frame, when *DataRateMode* is set to 2, leading to a PSDU data rate of 50 kbit/s.

symbol ( $b_0, \dots, b_3$ )	code word ( $c_0, \dots, c_{15}$ )
0000	1111100110100000
1000	0011111001101000
0100	0000111110011010
1100	1000001111100110
0010	1010000011111001
1010	0110100000111110
0110	1001101000001111
1110	1110011010000011
0001	0000011001011111
1001	1100000110010111
0101	1111000001100101
1101	0111110000011001
0011	0101111100000110
1011	1001011111000001
0111	0110010111110000
1111	0001100101111100

Table 3: C(16,4) coding.

### 1.6.3 C(8,4) coding

This code obtains code words of an extended (7,4)-BCH code of length  $N_3 = 8$ . Rate 1/2 coding shall be used for encoding the PSDU part of the frame, when *DataRateMode* is set to 3, leading to a PSDU data rate of 100 kbit/s.

symbol ( $b_0, \dots, b_3$ )	code word ( $c_0, \dots, c_7$ )
0000	00000001
1000	11010000
0100	01101000
1100	10111001
0010	11100101
1010	00110100
0110	10001100
1110	01011101
0001	10100010
1001	01110011
0101	11001011
1101	00011010
0011	01000110
1011	10010111
0111	00101111
1111	11111110

Table 4: C(8,4) coding.

#### 1.6.4 C(4,4) coding

This code obtains code words of length  $N_4 = 4$ . Rate 1 coding (simply a mapping) shall be used for encoding the PSDU part of the frame, when *DataRateMode* is set to 4, leading to the highest PSDU data rate of 200 kbit/s.



symbol ( $b_0, \dots, b_3$ )	code word ( $c_0, \dots, c_3$ )
0000	0000
1000	1000
0100	0100
1100	1100
0010	0010
1010	1010
0110	0110
1110	1110
0001	0001
1001	1001
0101	0101
1101	1101
0011	0011
1011	1011
0111	0111
1111	1111

Table 5: C(4,4) coding.

## 1.7 Generation of the chip sequence

During each code word period, the  $m$ -th component of the  $n$ -th code word  $c_m(s_n) \in \{0, 1\}$  shall be mapped onto a consecutive sequence

$$\tilde{\alpha}(k) = (-1)^{1+c_m(s_n)} \in \{-1, +1\} \quad k = 0, 1, \dots, K_L - 1$$

with

$$K_L = (8 + 3) \cdot N_1 \cdot 2 + PDSULength \cdot N_R \cdot 2$$

and  $s_n \in \{0, 1\}^4$  is the symbol value of the  $n$ -th symbol index in time.

The least significant code word component,  $c_0(s_n)$ , is transmitted first and the most significant component,  $c_{N_R-1}(s_n)$ , is transmitted last.

For all data rates other than *DataRateMode*  $R = 3$ , the sequence  $\tilde{\alpha}$  shall be directly passed to the to the GMSK modulator, i.e. the *chip sequence*  $\alpha = \{\alpha(k)\}$  is given by

$$\alpha(k) = \tilde{\alpha}(k)$$

For *DataRateMode*  $R = 3$ , the sequence  $\tilde{\alpha}$  shall be processed by an additional feed-forward pre-coder during the PSDU part before passing it to the GMSK modulator. The *chip sequence*  $\alpha = \{\alpha(k)\}$  is given by

$$\alpha(k) = \tilde{\alpha}(k) \cdot \tilde{\alpha}(k-1), \quad k = K_0, \dots, K_L - 1$$

where  $K_0 = (8 + 3) \cdot N_1 \cdot 2$  is the chip sampling point referring to the first codeword component of the PSDU and  $\tilde{\alpha}(K_0 - 1) = 1$ , see Figure 2.

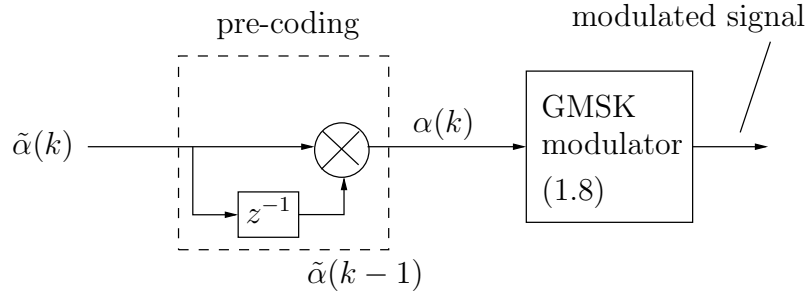

Figure 2: Pre-coding for *DataRateMode*  $R = 3$  during the PSDU part.

## 1.8 GMSK modulation

The chip sequence  $\alpha = \{\alpha(k)\}$  is modulated onto the carrier using GMSK. The baseband signal  $y(t, \alpha)$  is given by

$$y(t, \alpha) = \exp \left( j2\pi h \sum_{k=-\infty}^{+\infty} \alpha(k) \int_{-\infty}^{t-kT} g(\tau) d\tau \right) \quad (1)$$

where  $T = 5e-6$  [s] is the chip duration,  $h = 1/2$  is the modulation index and  $g$  is the Gaussian pulse

$$g(t) = \frac{1}{2} \left[ \operatorname{erf}(\gamma(\frac{t}{T} + \frac{1}{2})) - \operatorname{erf}(\gamma(\frac{t}{T} - \frac{1}{2})) \right] \quad (2)$$

with

$$\gamma = \sqrt{\frac{2}{\ln 2}} \pi BT \quad \text{and} \quad \operatorname{erf}(t) = \frac{2}{\sqrt{\pi}} \int_0^t \exp(-\tau^2) d\tau$$

For operation in channel 12,  $BT$  shall be 0.3 and for operation in channels 1 to 11,  $BT$  shall be 0.5, see sub-clause 1.9.

## 1.9 Channel numbering

This PHY supports up to 12 channels in order to facilitate *Adaptive Frequency Agility* (AFA). The center frequency  $f_c$  in [MHz] for a given channel number is shown in Table 6. Devices conforming to this PHY shall also comply with specific national restrictions, see [1] Annex 1 BAND-G for non-specific Short Range Devices.

channel number	1	2	3	4	5	6
$f_c$ [MHz]	863.4	863.8	864.2	864.6	865	865.4
channel number	7	8	9	10	11	12
$f_c$ [MHz]	866	866.6	867.2	867.8	868.3	868.95

Table 6: Channel center frequencies  $f_c$ .

## 1.10 Radio specifications

### 1.10.1 Clock offset tolerance

The clock offset tolerance shall be  $\pm 20$  ppm.

### 1.10.2 Receiver sensitivity

The receiver sensitivity threshold is the lowest input signal power in dBm measured at the antenna that yields a frame error rate  $\text{FER} \leq 0.01$  assuming random PSDU data and no interference.

Table 7 shows the required receiver sensitivity threshold depending on *DataRateMode* and the PSDU length.

<i>DataRateMode</i>	20 octets PSDU	1500 octets PSDU
1	-100	-90
2	-95	-85
3	-90	-80
4	-85	-75

Table 7: Required receiver sensitivity threshold [dBm].

### 1.10.3 Adjacent channel rejection

The interference-to-signal ratio (ISR) is the maximum ratio of the signal power of an interferer relative to the signal power of the desired signal that leads to a frame error rate of  $\text{FER} \leq 0.01$ .

The adjacent channel rejection shall be measured as follows: the desired signal shall be a compliant signal of this PHY, of pseudo-random PSDU data. The desired signal is input to the receiver at a level 3 dB above the maximum allowed receiver sensitivity given in Table 7.

The interfering signal shall be a compliant signal of this PHY, of pseudo-random PSDU data with *DataRateMode* = 4 and  $BT = 0.5$ . The interferer is separated in frequency by  $|\delta f_c|$  from the carrier frequency  $f_c$  of the desired channel with a minimum ISR as

shown in Table 8. The test shall be performed for only one interfering signal at a time. The receiver shall meet the error rate criteria defined in 1.10.2 under these conditions.

$ \delta f_c $ [kHz]	300	400	500	600	800	1000	1200
minimum ISR [dB]	0	10	20	30	40	50	60

Table 8: Minimum interference-to-signal ratio (ISR) depending on  $|\delta f_c|$ .

## 1.11 PPDU format

Figure 3 shows the PPDU format of the PHY.

Octets: 8	1	2				4 ... 2047
Preamble	SFD	Data rate 2 bit	Frame length 11 bit	Reserved 2 bit	(Parity) 1 bit	PSDU (incl. FCS-32)
SHR		PHR				PHY payload

Figure 3: Format of the PPDU.

### 1.11.1 Preamble field

The preamble consists of 8 zero octets. The octets are encoded with C(32,4) coding according to sub-clause 1.6.1.

### 1.11.2 SFD field

The SFD is a 1 octet field indicating the end of the synchronization (preamble) field and the start of the packet data. The SFD shall be formatted as illustrated in Figure 9 and shall be encoded with C(32,4) coding according to sub-clause 1.6.1.

Bits:	0	1	2	3	4	5	6	7
	1	1	1	0	0	1	0	1

Table 9: Format of the SFD field.

### 1.11.3 PHR field

The PHR field is a 2 octet field (16 bits).

- The subfield  $b_0 \dots b_1$  specifies *DataRateMode* of the PSDU<sup>1</sup>, see Table 10.

<sup>1</sup>Since this information is transmitted during the first octet in time, there is sufficient time to adjust the receiver for the upcoming data rate.

- The subfield  $b_2 \dots b_{12}$  specifies  $PDSULength$ , the number of PSDU octets.
- The subfield  $b_{13} \dots b_{14}$  is reserved.
- The bit  $b_{15}$  is reserved for a parity check symbol<sup>2</sup>.

<i>DataRateMode</i>	$b_0$	$b_1$
4	1	1
3	0	1
2	1	0
1	0	0

Table 10: Encoding of *DataRateMode* in the PHR field.

The PHR field is encoded with C(32,4) coding according to sub-clause 1.6.1.

#### 1.11.4 PSDU

The PSDU consists of 4 to 2047 octets including a 4 octets (32 bits) Frame Check Sequence<sup>3</sup> (FCS). The PSDU can be transmitted at various data rates according to Table 1, employing different types of block coding.

---

<sup>2</sup>The probability of undetected error for a  $(n, n-1, 1)_2$  parity check code is known to be  $P_{ue} \approx \frac{n(n-1)}{2} p_e^2$  for small  $p_e$ , [3]. Protection of the PHR field deserves a more detailed analysis conditioned on the SHR detection.

<sup>3</sup>Details are to be discussed in the group.

## 2 Appendix

### 2.1 European regularity requirements for the 863-870 MHz band

Usage of the 863-870 MHz band (BAND-G according to [1]) is subject to various regularity requirements for non-specific Short Range Devices (SRD). With regard to [1], for DSSS and other wide-band modulation the following restrictions apply:

- The duty cycle must be  $\leq 0.1\%$ . Alternatively, *Listen Before Talk* (LBT) [2] in conjunction with frequency agility can be applied, avoiding the duty cycle restriction.
- Sub-bands for alarms are excluded (see [1] Annex 7)
- The maximum power spectral density shall be  $-4.5$  dBm/100 kHz. The power density can be increased to  $+6.2$  dBm/100 kHz and  $+0.8$  dBm/100 kHz, if the band of operation is limited to 865-868 MHz and 865-870 MHz, respectively.

Usage of the whole BAND-G for non-specific SRDs is subject to national restrictions, as shown in Table 11. It is, however, conceivable that some of the national restrictions may be relaxed or clarified in the future. Usage of the sub-bands G1 and G2 is less restricted.

Country	Restriction	Reason/remark
Austria	Not implemented	Planned
Belgium	Not implemented	
France	Not implemented	
Greece	Limited implementation to 863-865 MHz	
Hungary	Voice and audio applications are excluded	
Latvia	Not implemented	
Lithuania	Not implemented	
Norway	Not implemented	
Russian Federation	Limited implementation	864-865 MHz with max e.r.p 25 mW, duty cycle 0.1% or LBT. Forbidden to use at the airports (aerodromes)
Slovak Republic	Not implemented	Under study
Spain	Not implemented	Fixed Service
Sweden	Not implemented	
The Netherlands	Not implemented	Under study

Table 11: National restrictions for non-specific Short Range Devices using the 863-870 MHz band [1].

The channel assignment specified in Table 6 is motivated by ERC recommendation [1]. This is shown in Figure 4. The sub-band G2 is surrounded by sub-bands for alarms.  $BT$  should be 0.3 rather than 0.5 for this channel in order to meet the limit of -36 dBm/100 kHz out-of-band emissions, see [2]. For RFID interrogators, no LBT is required. Therefore, channel spacing is 600 kHz within 885-868 MHz, avoiding the center frequencies of RFID interrogators, see [1] Annex 11.

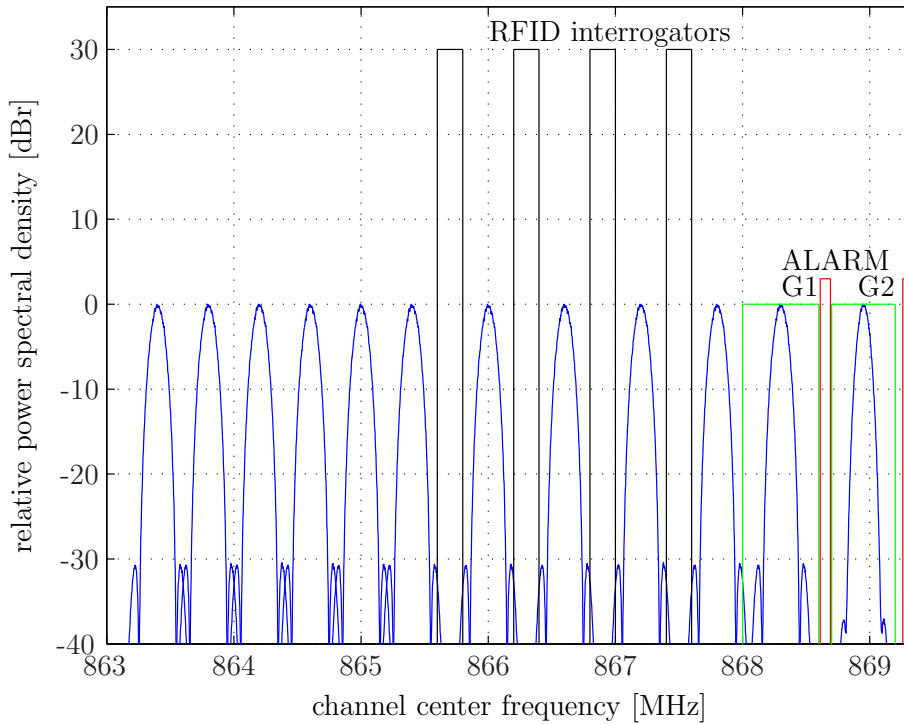

Figure 4: Suggested channel frequencies when utilizing BAND-G.

## 2.2 Coding for GMSK

In order to understand the motivation of coded GMSK applied in this PHY proposal, it is worth referring to the Laurent approximation of a continuous phase modulated (CPM) signal. It is known that GMSK with  $BT \geq 0.3$  can be well approximated by frequency shifted DBPSK

$$y(t, \alpha) \approx \sum_{k=-\infty}^{\infty} \beta(k) j^k h_0(t - kT) \quad (3)$$

with

$$\beta(k) = \beta(k-1) \cdot \alpha(k) \quad (4)$$

and  $h_0$  refers to the main Laurent impulse relating to the Gaussian pulse  $g$ ; for details see [4, 5, 6].



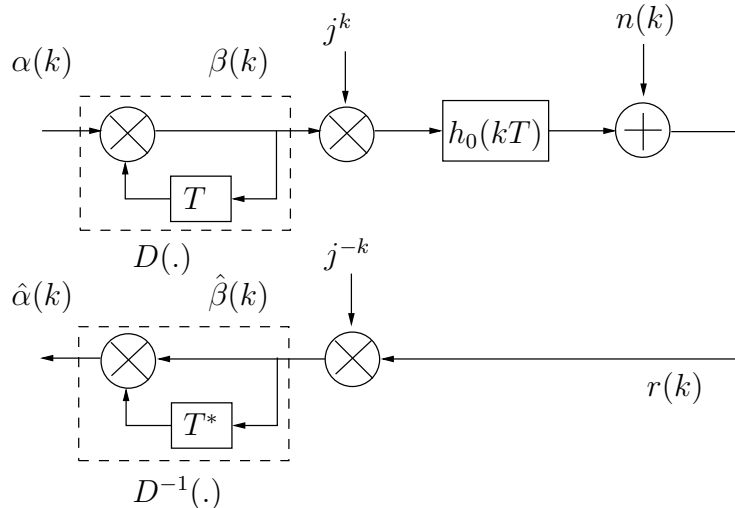

Figure 5: Discrete-time transmission model based on Laurent approximation.

Figure 5 depicts the overall transmission model, when neglecting the influence of inter chip interference due to  $h_0$ . It appears that a non-coherent differential demodulator cancels out the influence of the recursive rate-1 encoder  $D(\cdot)$ , since the operation  $D^{-1}(\cdot)$  is part of a differential demodulator. For coherent demodulation, operation  $D^{-1}(\cdot)$  is usually avoided in order to reduce the influence of noise enhancement (leading to a gain of approximately 3 dB), [7]. Consequently, coherent detection is preferably based on the transformed codes  $C^\beta$  with regard to equation (4).

A target of this PHY proposal is to support both, coherent and non-coherent demodulation for the mandatory modes  $R = 1$  and  $R = 2$ . Since both demodulation schemes offer certain benefits, the codes have been designed such, that  $C^\alpha$  and  $C^\beta$  obtain similar code properties with respect to the minimum distance, i. e., the codes are *balanced*, see Table 12. Moreover, Table 12 shows the optimum minimum distance of a corresponding ( $\{32, 16\}, k = 4$ ) linear code [8], although the codes  $C(32,4)$  and  $C(16,4)$  are non-linear codes<sup>4</sup>.

<i>DataRateMode</i>	$d_{min}^\alpha$	$d_{min}^\beta$	$d_{min}^{opt,linear}$
1	14	14	16
2	6	6	8

Table 12: Minimum distance of the codes  $C^\alpha = C$  and  $C^\beta$ , respectively.

In order to remove the effect of  $D(\cdot)$  for coherent detection, pre-coding can be applied, i. e. passing

$$\tilde{\alpha}(k) = \alpha(k) \cdot \alpha(k-1) \quad (5)$$

<sup>4</sup>The main author is grateful to Kai-Uwe Schmidt, Simon Fraser University, Burnaby, Canada, for his helpful hints on coding bounds.

to the GMSK modulator, [5]. In this case, however, the code properties may be poor, when applying a differential non-coherent demodulator.

However, for the optional *DataRateMode*  $R = 3$ , finding good balanced C(8,4)-codes appears to be difficult. Therefore, pre-coding is used here, see Figure 2. For coherent demodulation, the optimal minimum distance  $d_{min} = 4$  (see [8]) of the extended (7,4)-BCH code can be exploited. Differential non-coherent demodulation is not applicable for *DataRateMode*  $R = 3$ .

Another aspect with respect to coherent detection (when applying decision feedback based phase error correction) is the maximum code length  $N_R$ . Coherent detection requires both, frequency offset correction (due to clock offset) and phase error correction. Given a residual error of the estimate of the clock offset  $\delta p = p - \hat{p}$ , the phase drift after frequency offset and phase correction is given by

$$\delta\phi = N_R \cdot 2\pi \cdot \frac{f_c}{f_{chip}} \cdot \delta p \quad (6)$$

With carrier frequency  $f_c = 868$  MHz, and assuming that the maximum estimation error of  $\delta p$  is less than 0.5e-6, the maximum phase deviation can be bound to  $\delta\phi \approx \pi/8$  which results in a marginal performance loss with respect to the BPSK equivalent of GMSK. An estimation error less than 0.5 ppm was found to be achievable at low implementation cost even at the sensitivity level of -116 dBm, see section 2.6. However, for code lengths considerably larger than 32 this requirement will become more challenging. Therefore, the code length has been constrained to  $N_{R=1} = 32$ .

The code design of C(32,4) is also relevant for synchronization, since the preamble consists of 16 repetitions of the zero code word

$$c^{(32,4)}((0000)) = (01101001000010101110110001111100)$$

Therefore, C(32,4) has been designed under the constraint, that the zero code word obtains good auto-correlation properties. In particular,  $c^{(32,4)}((0000))$  is an extended maximum length sequences for  $m = 5$  with minimal polynomial  $X + X^2 + X^5$ , [9].

It should be noted, however, that the codes considered in this PHY do mainly serve for a simple means for data rate adjustment rather than exploiting a coding gain, since their properties are extremely modest in comparison to powerful (capacity achieving) forward error-correcting codes.

## 2.3 SHR and PHR field

The preamble consisting of 8 zero octets has a duration of 2.56 ms. The portion of 8 octets with regard to the maximum PSDU length of 2047 seems to be consistent with other standards. In fact, the preamble is a key factor for a robust communication system and its purpose is often underestimated.

- *Coherent Detection.* It is well known that coherent detection leads to an improved performance compared to non-coherent detection, provided that phase estimation

and tracking can be reliably performed. Coherent detection requires a fine frequency estimation which is supported by preambles of appropriate lengths and symbols. This PHY supports coherent detection as shown in section 2.6.

- *Antenna Diversity.* For a cost efficient implementation of antenna diversity, switching between two or more antennas (sufficiently separated in space and/or direction) during preamble search is a well known method to improve robustness against frequency selectivity or shadowing. The preamble must not be too short, in order to find a reliable quality measure when selecting the antenna.
- *Channel Estimation.* The robustness against frequency selectivity can be considerably improved when applying equalization, especially for the high data rate modes. This in turn requires a reliable Channel Estimation (CES). The preamble of this PHY supports CES with regard to the code sequences (auto-correlation properties) and gives sufficient support for adaptive estimation due to its length.
- *Support for advanced outer coding.* When applying high data rate transmission with significant PSDU lengths, there is a considerable gap between a misdetection of the (SHR,PHR) and the occurrence of a PSDU error, since SHR and PHR are rate 1/8 encoded. Such a gap is profitable when considering advanced outer forward error-correcting coding of a moderate code rate, such as code rates within(0.5...0.9). At higher layers, algebraic coding (e.g. RS or BCH coding) could be considered.

It should be noted that low-rate encoding of the header is also applied in other standards, such as IEEE 802.11.

## 2.4 Spectral properties

In Figure 6, plots of the spectral density of several baseband signals (all having the same variance) are shown, assuming random PSDU data. The spectra for *DataRateMode*  $R = 1$  and  $R = 2$  show code dependent peaks and notches. A smooth spectrum is obtained for  $R = 3$  due to pre-coding. For channel 12, the occupied bandwidth must be constrained to 500 kHz. In order to meet the limit of -36 dBm/100 kHz out-of-band emissions (at sufficient output power and in the presence of  $\pm 20$  ppm clock offset),  $BT = 0.3$  is suggested.

Also shown are spectra of the IEEE 802.15.4-2006 BPSK and OQPSK modes for the 868 MHz band, supporting a data rate of 20 and 100 kbit/s, respectively. Compared to GMSK, the power spectra of these modes seem to be better utilized. The OQPSK mode applies both, half-sine shaping and raised cosine shaping with roll-off factor 0.2 and a certain C(16,4) code at a chip rate of 400 kchip/s, see [10]. However, this signal is not a constant envelope signal, which may lead to spectral re-growth depending on the PA design. Moreover, the first Nyquist criteria is violated. The BPSK mode applies raised cosine shaping with roll-off factor 1.0 using C(15,1) coding at a chip rate of 300 kchip/s. This signal shaping meets the first Nyquist criteria but the constant envelope property

is not met either. Another issue of BPSK is related to images due to I/Q imbalance, see section 2.5.

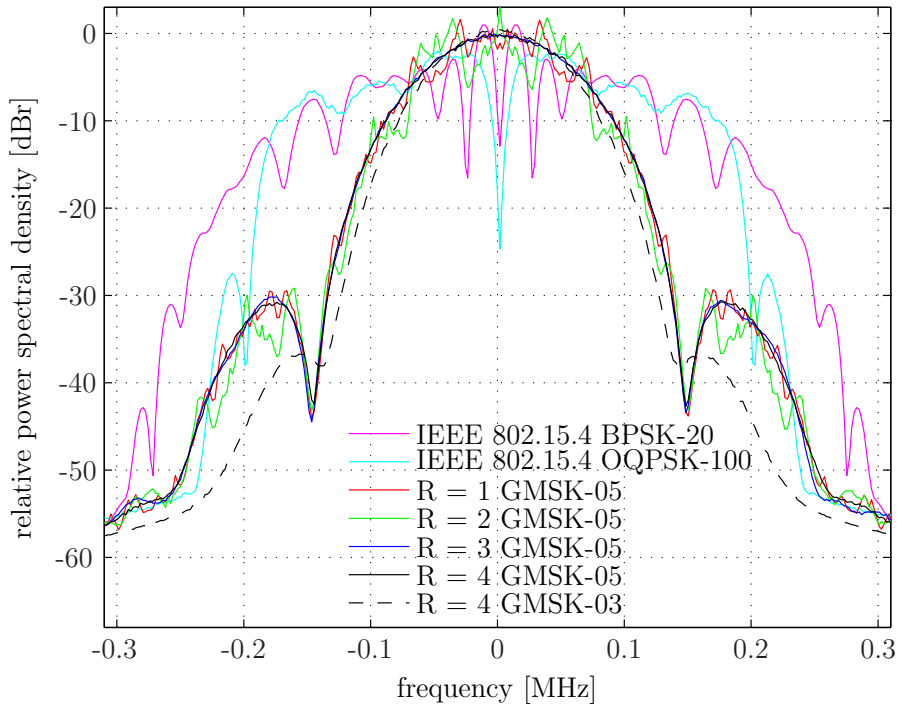

Figure 6: Relative baseband power spectra, assuming random PSDU data.

## 2.5 I/Q imbalance

Low-IF receiver architectures are very popular, especially for narrow band signals. However, a known problem of a low-IF receiver is related to I/Q imbalances. Let

$$x(k) = x_r(k) + jx_i(k) = y(kT_s, \alpha)$$

be the discrete-time signal due to sampling at a certain sampling rate  $1/T_s$ . Then

$$x^{IQ}(k) = (1 + \delta)x_r(k) + j(1 - \delta)x_i(k)$$

is the signal due to I/Q imbalance for some  $1 > \delta \geq 0$ . No assume  $x = \{x(k)\}$  is left-analytic, i.e.

$$X(e^{j\Omega}) = 0 \quad \text{for } \Omega \geq 0$$

where  $X$  is the Fourier transformed signal<sup>5</sup> of  $x$ . The Fourier transformed signal of  $x^{IQ}$  is given by

$$X^{IQ}(e^{j\Omega}) = X(e^{j\Omega}) + \delta X^*(e^{-j\Omega})$$

<sup>5</sup>For simplicity we assume,  $X(e^{j\Omega}) = \sum_{k=-\infty}^{\infty} x(k)e^{-jk\Omega}$  exists for  $-\pi < \Omega \leq \pi$ .

This implies that an image signal  $\delta x^*(k)$  will be symmetrically mirrored to the right side and may fall into the in-band, if the normalized IF is  $\Omega_{IF}$  and  $x$  is separated in frequency by  $2\Omega_{IF}$  w. r. t. the IF. For GMSK, such an image can be distinguished from a desired signal, since  $x$  is complex. For a real-valued signal, (like BPSK) the I/Q-image is not dissolvable at the PHY layer<sup>6</sup>. Hence, care must be taken with respect to the choice of the IF and the desired channel spacing. Since GMSK can be approximated by  $\pi/2$ -frequency shifted DBPSK, see equation (3), there are non-dissolvable images too, but those images do not completely fall into the in-band and are, therefore, usually considerably suppressed by the in-band filter.

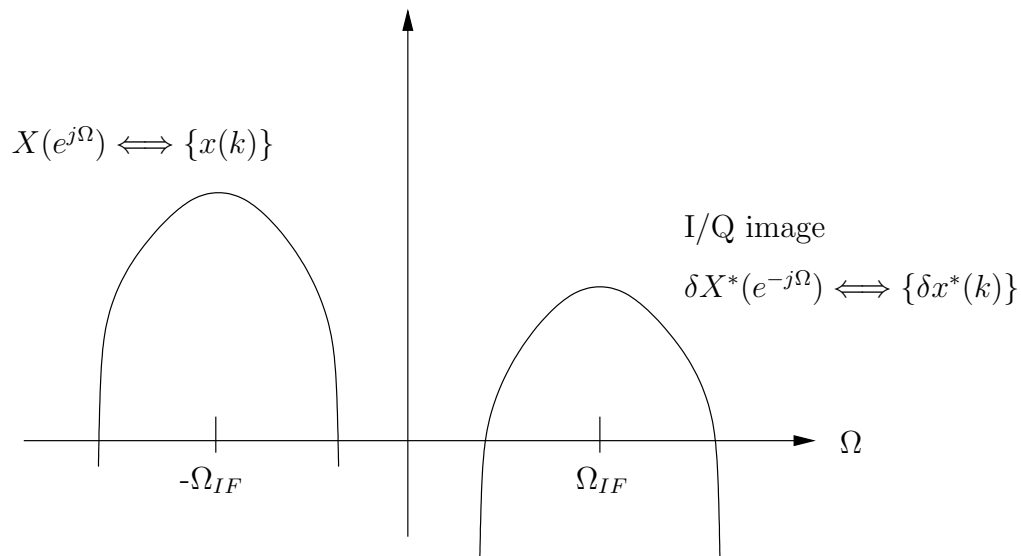

Figure 7: I/Q image due to I/Q imbalance.

## 2.6 Simulation results

This section shows some Matlab<sup>®</sup>/GNU-Octave<sup>7</sup>-based simulation results. A receiver front end of moderate complexity is considered. The receiver is a low-IF receiver with IF equal to 0.2 MHz. The bandwidth of the receive filter is 0.2 MHz centered at the IF, leading to a moderate filter pole-Q. DC suppression is modelled by a highpass filter of 50 kHz cutoff frequency. A simple limiter path is used for ADC applying 8 MHz oversampling and discrete-time post filtering. For impairments, LNA noise of -174 dBm/Hz has been assumed with a noise figure of 5 dB. I/Q imbalance is assumed to be 0.7 degree, leading to an image of approx. -45 dB. For GMSK, no equalization is applied.

For coherent detection, coarse and fine clock offset estimation is performed during synchronization. During reception, simple first order decision feedback phase tracking is applied in addition to clock drift compensation [5]. For non-coherent detection, coarse

<sup>6</sup>The unwanted signal can be dissolved at the MAC layer by address filtering.

<sup>7</sup><http://www.gnu.org/software/octave/>

clock offset estimation is performed during synchronization and well-known differential demodulation is used for detection along with clock drift compensation.

Figure 8 shows simulation results for coherent demodulation. MSK and GMSK with  $BT = 0.5$  and  $BT = 0.3$  is considered. For  $BT = 0.5$ , there is only a small loss in performance with respect to the influence of Gaussian shaping, especially in the presence of coding. The loss for  $BT = 0.3$  is larger, especially for *DataRateMode*  $R = 4$ .

The lowest sensitivity can be achieved at approx. -116 dBm which reveals a minor coding gain of 1 dB in addition to the processing gain of 9 dB. (Note that timing synchronization and clock-offset estimation need to be performed at much lower SNR for *DataRateMode*  $R = 1$ .)

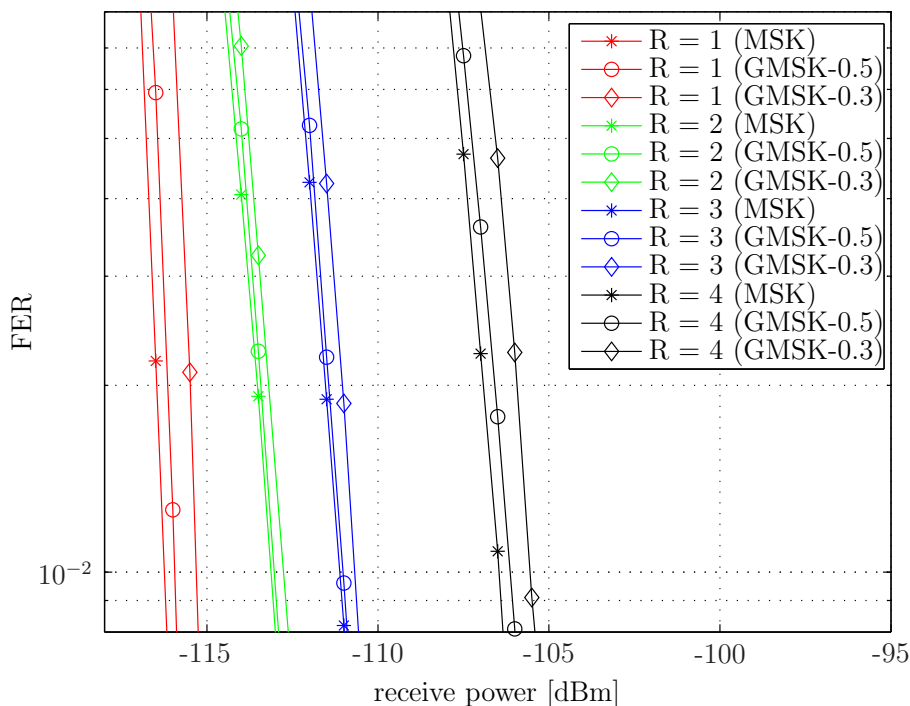

Figure 8: Frame Error Rate, AWGN, 20 octets PSDU, coherent detection, no equalization for GMSK.

Figure 9 shows simulation results for non-coherent demodulation. There is a noticeable loss in performance due to the influence of Gaussian shaping, especially in case of *DataRateMode*  $R = 4$  and  $BT = 0.3$ .

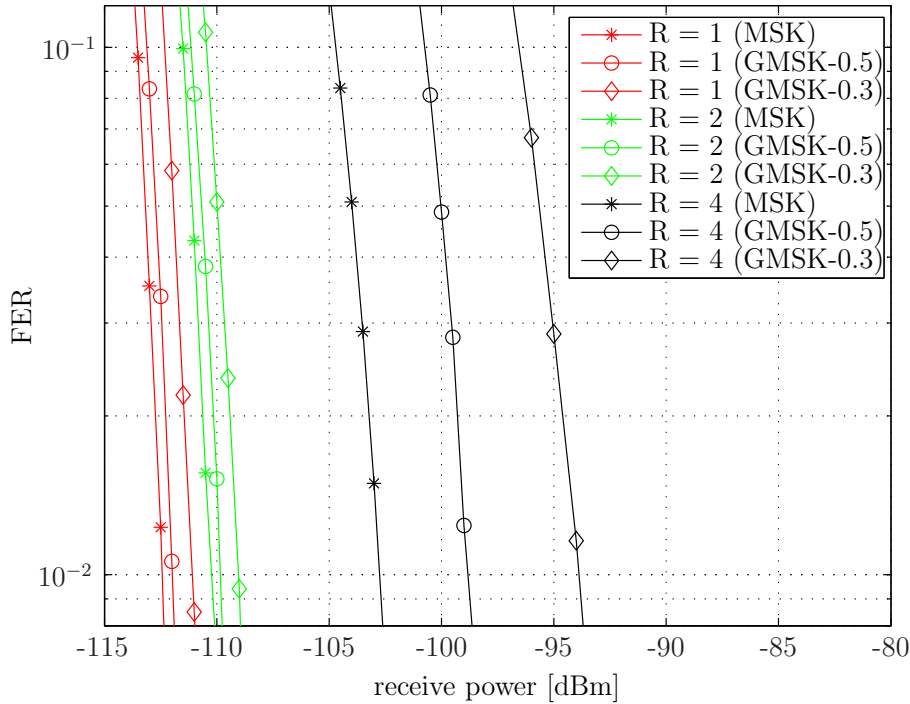

Figure 9: Frame Error Rate, AWGN, 20 octets PSDU, non-coherent detection, no equalization for GMSK.

Choosing  $BT = 0.5$  seems to be a good choice. GMSK with  $BT = 0.5$  results in improved spectral properties compared to MSK and still allows a simple MSK-like receiver architecture.

Figure 10 shows simulation results for long PSDUs of 2047 octets for *DataRateMode*  $R = 1$  and  $R = 4$ , respectively. Both TX and RX obtain the maximum opposite clock offset of 20 ppm each, leading to an overall clock offset of 40 ppm. The relative degradation with respect to shorter PSDU lengths is more severe for the differential non-coherent detection algorithm applied in this simulation.

The performance of differential demodulation without equalization for *DataRateMode*  $R = 4$  and  $BT = 0.3$  is not shown in the graph since it is considerably worse than all other constellations. In order to meet the requirements given in Table 7, coherent demodulation is recommended. Note that coherent demodulation is considerably simpler for *DataRateMode*  $R = 4$  than for  $R = 1$ , see equation (6). Alternatively, equalization techniques as shown in [6] can be applied.

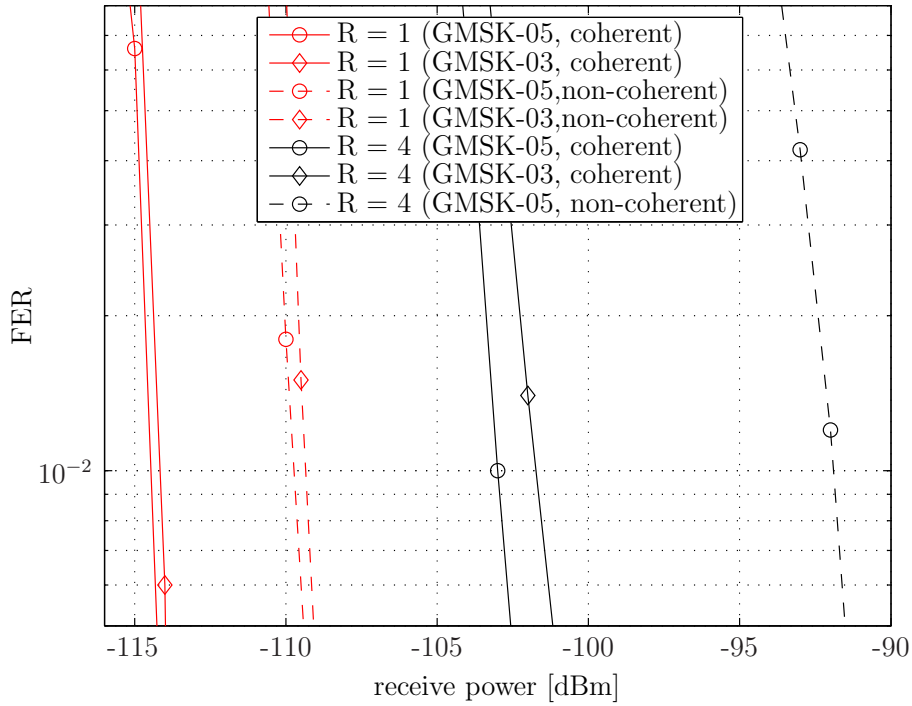

Figure 10: Frame Error Rate, AWGN, 2047 octets PSDU, 40 ppm overall clock offset, no equalization.

For long PSDUs with *DataRateMode*  $R = 4$ , the combination with more advanced forward error-correcting coding is very attractive, especially if the soft information of the demodulated PSDU chips is not discarded.



## References

- [1] European Radiocommunications Office, *ERC RECOMMENDATION 70-03 (Tromsø 1997 and subsequent amendments) RELATING TO THE USE OF SHORT RANGE DEVICES (SRD)*, Apr. 2009.
- [2] ETSI, *Draft ETSI EN 300 220-1 V2.2.1 (2008-04), Electromagnetic compatibility and Radio spectrum Matters (ERM); Short Range Devices (SRD); Radio equipment to be used in the 25 MHz to 1 000 MHz frequency range with power levels ranging up to 500 mW; Part 1: Technical characteristics and test methods*, Apr. 2008.
- [3] Bernd Friedrichs, *Kanalcodierung*, Springer-Verlag, 1996.
- [4] P. Laurent, “Exact and Approximate Construction of Digital Phase Modulations by Superposition of Amplitude Modulated Pulses (APM),” *IEEE Trans. Commun.*, vol. COM-34, no. 2, pp. 150–160, 1986.
- [5] Karl Dirk Kammeyer, *Nachrichtenübertragung*, B. G. Teubner, 2nd edition, 1996.
- [6] Houhao Wang, “Reduced-complexity Noncoherent Receiver for GMSK Signals,” M.S. thesis, University of Toronto, Department of Electrical and Computer Engineering, 2001, <https://tspace.library.utoronto.ca/>.
- [7] John G. Proakis, *Digital Communications*, McGraw-Hill Book Co., 3rd edition, 1995.
- [8] Markus Grassl, “Code tables,” <http://www.codetables.de>.
- [9] Shu Lin and Daniel J. Costello, Jr, *Error Control Coding: Fundamentals and Applications*, Prentice-Hall, Inc., 1983.
- [10] IEEE, *IEEE-802.15.4 Standard, Part 15.4: Wireless Medium Access Control (MAC) and Physical Layer (PHY) Specifications for Low-Rate Wireless Personal Area Networks (LR-WPANs)*, 2006.