

**Project: IEEE P802.15 Working Group for Wireless Personal Area Networks (WPANs)**

**Submission Title:** [IMEC Narrowband MAC Proposal]

**Date Submitted:** [4 May, 2009]

**Source:** [Yan Zhang, Guido Dolmans, Li Huang, Xiongchuan Huang]

Company [Holst Centre / IMEC-NL]

Address [High Tech Campus 31, Eindhoven, the Netherlands]

Voice:[+31 40 2774094], FAX: [+44 40 2746400],

E-Mail:[Yan.Zhang, Guido.Dolmans, Li.Huang, Xiongchuan.Huang @imec-nl.nl]

[Maarten Lont, Dusan Milosevic, Peter Baltus]

University [Eindhoven University of Technology ]

**Abstract:** [This presentation is the second part of IMEC's narrowband proposal for IEEE 802.15.6. It focuses on the MAC proposal. ]

**Purpose:** [For discussion by the group in order to provide a standard for IEEE P802.15.6.]

**Notice:** This document has been prepared to assist the IEEE P802.15. It is offered as a basis for discussion and is not binding on the contributing individual(s) or organization(s). The material in this document is subject to change in form and content after further study. The contributor(s) reserve(s) the right to add, amend or withdraw material contained herein.

**Release:** The contributor acknowledges and accepts that this contribution becomes the property of IEEE and may be made publicly available by P802.15.

## 802.15.6 Technical Requirements

- Miniaturized sensor nodes – small form factor
- Limited range (3 meters, extendable to 5 meters)
- Significant path loss
- Energy scavenging / battery-less operation
- Scalable data rate: 10 kbps - 10 Mbps
- Extremely low consumption power (0.1 to 1 mW)
- Different classes of QoS for high reliability, low latency, asymmetric traffic
- Energy efficient, low complexity MAC and upper layers
- High security/privacy required for certain applications

# Dual-Radio System

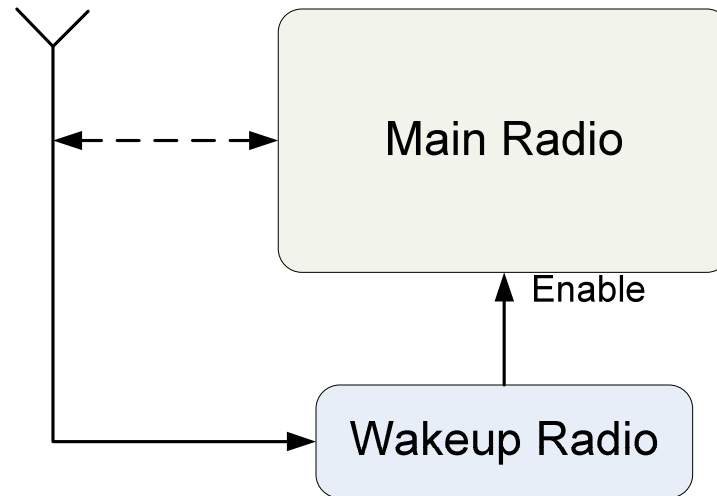

Typical application scenarios of dual-radio system:

- Emergent/on-demand communication
- Low traffic activity
- Ultra low power consumption

# IMEC's Dual Radio Proposal

- **IMEC's Narrowband Proposal:**
  - Main radio and wakeup radio in the ISM band 2.4 – 2.485 GHz with possible 2.36 – 2.4 GHz MBAN extension.
  - Hardware of two radios can be shared.
  - Wakeup radio overrules the MAC of the main radio in case of strict latency and/or high energy efficiency requirements.
- **Part 1 of the proposal**
  - PHY proposal in the main radio.
- **Part 2 of the proposal**
  - MAC proposal in the main radio.
  - Wakeup radio proposal.

## Summary

IMEC narrowband MAC proposal includes two parts:

- **Beacon-enabled mode: Priority-guaranteed MAC Protocol**
  - ✓ Data and control channels are separated to support high data rate application. Only the control channel is reservation-based. The data channel is allocated on demand.
  - ✓ Control channel is split into application-specific sub-channels to provide high priority to life-critical medical application.
  - ✓ Control channel size is designed to be adaptive to the application scenario for scalability purpose.
- **Non-beacon / emergency mode: Wakeup radio enhancement**
  - ✓ Separate wakeup radio can be used as an enhancement to the priority-guaranteed MAC for non-beacon mode or emergency mode.
  - ✓ Details about wakeup radio implementation are specified.
  - ✓ Applicability of wakeup radio for energy efficiency maximization are modeled and quantified with typical parameters.

- Improved quality-of-service (throughput, access latency, priority)
- High scalability is realized with high resource and energy efficiency.
- All the three topologies, star, cluster-tree and the peer-to-peer, are to be supported.
- Broadcast and multicast can be easily implemented.

# Outline of IMEC Narrowband MAC

## ❖ Part 1:

Priority-guaranteed MAC and Combined Solution

## ❖ Part 2:

Wakeup Radio Details

Part 1

**Priority-guaranteed MAC Protocol and  
Combined Solution for Wireless BANs**

IMEC-NL  
May, 2009

# Outline of Part 1

- Targeted Applications and Requirements
- Overview of MAC Protocols
- Priority-guaranteed MAC Protocol
- Performance Comparison
- Combined Solution to Emergent Medical Applications
- Summary



# Targeted Applications and Requirements

# Targeted Applications

## ➤ Medical Applications

- low data rate (<200kbps)
- typically periodic (medical monitoring)
- strict latency requirement
- high reliability
- ultra-low power consumption

## ➤ CE Applications

- medium to high data rate (500kbps~10Mbps)
- less strict latency requirement

# MAC Performance Criteria

In general, the performance of MAC protocol can be evaluated by :

- **Throughput**: high data rate applications
- **Access latency**: life-critical medical / real-time CE applications
- **Energy efficiency**: implanted sensor node, mobile terminal

*For the applications to be addressed in BAN, what are the key concerns in MAC protocol design?*

✓ *Medical application*

Energy efficiency and access latency are the two key concerns.

✓ *CE application*

Throughput and energy efficiency are the main concerns, while latency requirements should also be satisfied.

# Overview of MAC protocols

# MAC Overviews

	Contention-based	Schedule-based
<b>Pros</b> 😊	High scalability Infrastructureless	High energy efficiency Guaranteed QoS
<b>Cons</b> 😞	Prone to collision No QoS guarantee	Low resource efficiency Low scalability

MAC in related standard (IEEE 802.15.4 WPAN):

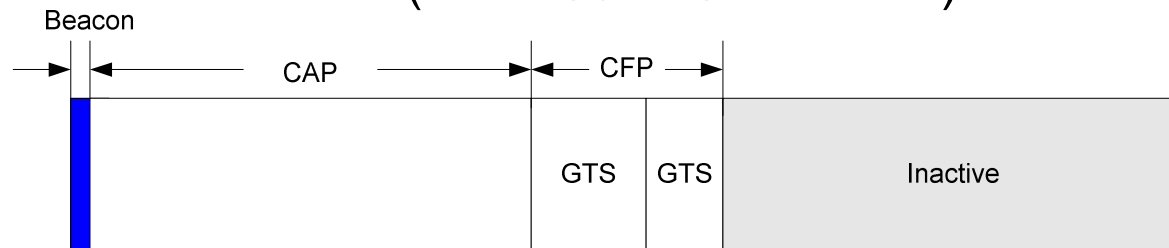

IEEE 802.15.4 frame structure

- CAP: contention access period (slotted CSMA-CA)
- CFP: contention free period (TDMA)

# Chance of MAC Reusing (1)

To get the radio resource on CFP, medical traffic competes with CE traffic on the CAP channel.

## CSMA-CA access contention on the CAP channel

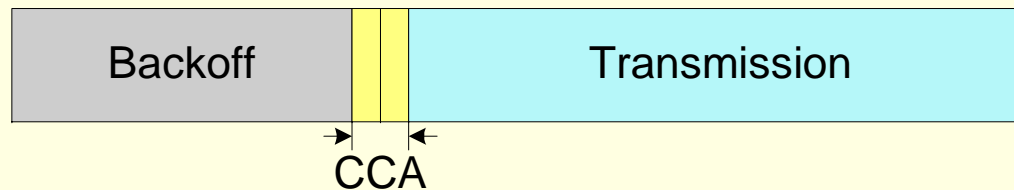

### Steps:

1. Generate a random backoff delay  $BK \in [0, 2^{BE}-1]$
2. Wait for the backoff delay to expire
3. Implement clear channel assessment (CCA) for  $CW$  backoff timeslot(s)

If multiple users start the CCA stage at the same moment, packet collision happens when the channel is clear during the CCA period.

*Collision is unavoidable in the random access procedure on CAP.*

# Chance of MAC Reusing (2)

## Collision Rate of CSMA-CA Mechanism

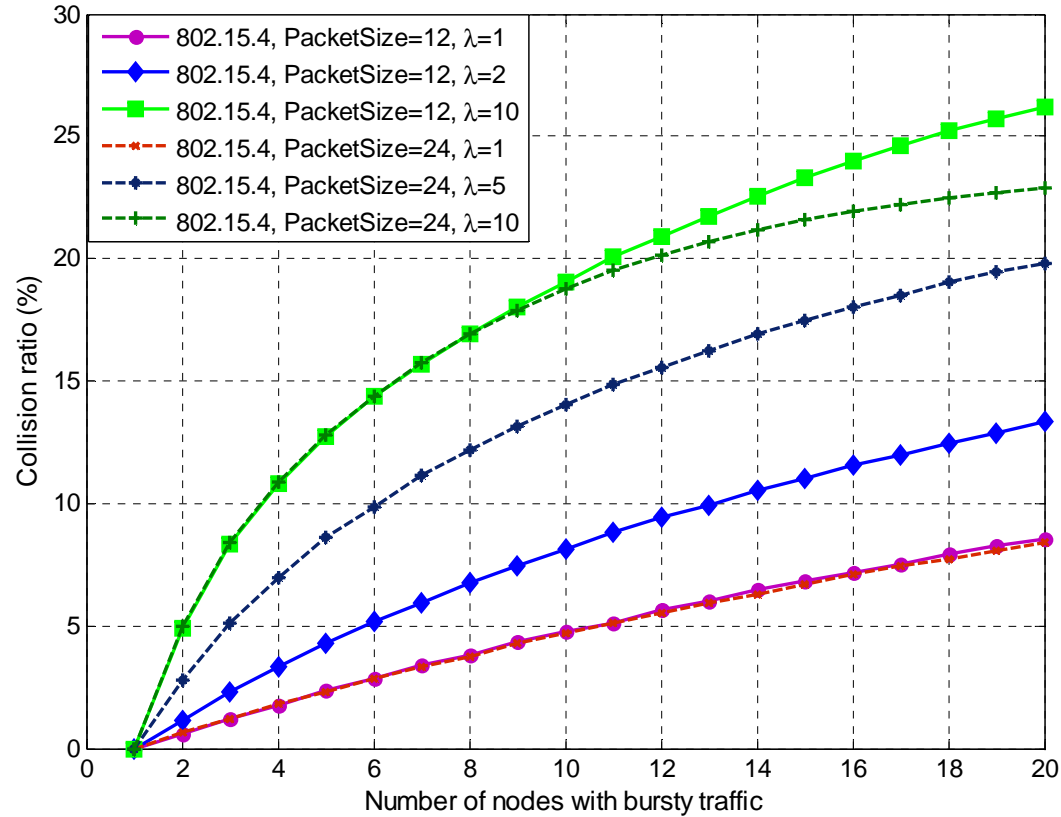

Packet collision rate with IEEE 802.15.4 MAC is closely related to:

- Number of users in the system
- Packet arrival rate

## Chance of MAC Reusing (3)

- Difference on the arrival rates of channel access request:

Periodic traffic: request is initiated only at the beginning of a period.

Bursty traffic: request is per packet / short session based.

CE applications with high data rate are typically much busier than medical applications, and lead to higher collision rate in channel access procedure.

Packet collision leads to

- Extra energy consumption
- Extra access latency
- Worsen random access contention

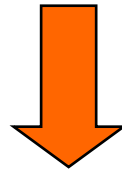

*QoS of Medical traffic will be greatly deteriorated by the CE traffic.*

**Application-specific access channel is a necessary.**



# Priority-guaranteed MAC

# Superframe Structure

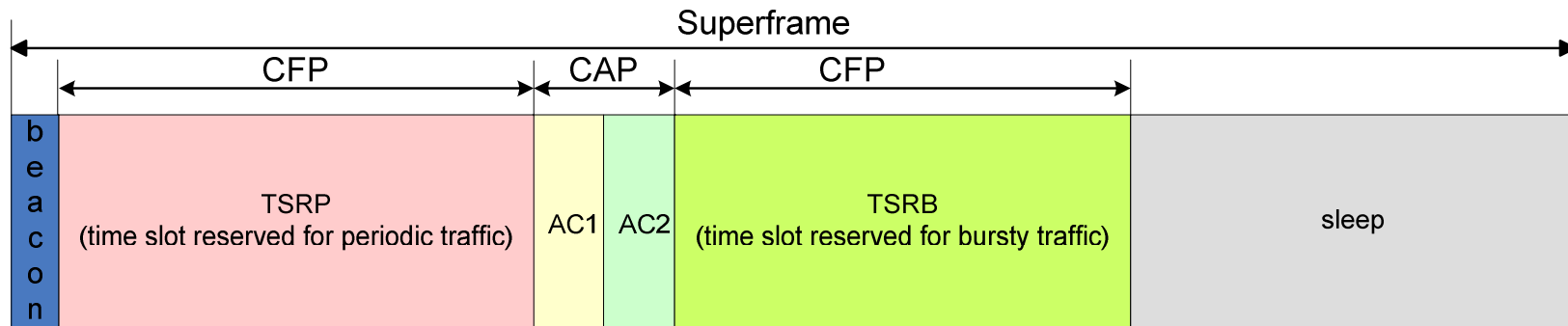

The active part of one superframe is slotted into:

- Beacon: used for synchronization and downlink control
- **Application-specific** uplink control channels: AC1 and AC2  
→ **Randomized slotted Aloha** (CAP)
- **Traffic-specific** data channels: TSRP and TSRB  
→ **TDMA on demand** (CFP)

## Channel allocation:

AC1 is used for access contention of life-critical medical application.

AC2 is used for access contention of CE and other applications.

TSRP is the Time Slot Reserved for Periodic traffic on a regular basis.

TSRB is the Time Slot Reserved for Bursty traffic on per session / packet basis.

Note: **TSRP is implemented for flexibility and energy efficiency consideration.** As to be explained afterwards, the CAP part is designed to be adaptive. By putting TSRP ahead of CAP, the periodic traffic can keep a fixed duty cycle without noticing the change on the CAP, and avoid beacon-listening in every superframe as long as clock drift allows.

## Slot size:

Control and data channels have different slot sizes.

control channel: basic size  $t_b$  → to accommodate one control packet and the ACK.

data channel:  $kt_b$  (eg.  $k=1,2,4,8,16$ ) → to facilitate low to high data rate.

Small data packet can be piggybacked in the control channel to improve the resource and energy efficiency.

# Channel Access Procedure

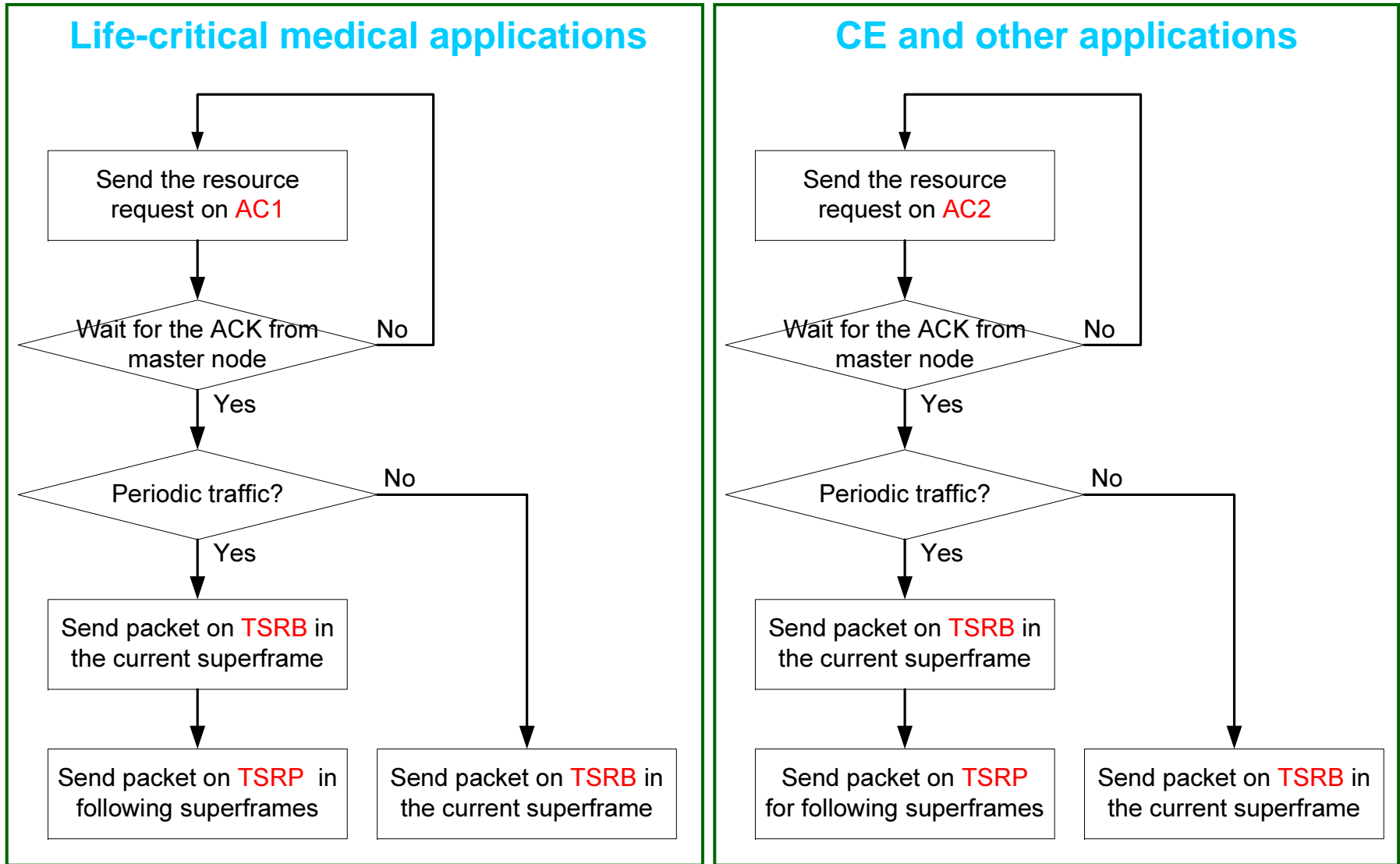

# Adaptive Control Channel Design

To minimize collision rate without sacrificing resource efficiency,

the size of control channel length should be adaptive to the number of users in the system and the traffic load.

Assume the number of users arrived in one superframe is  $\Delta N$ ,

$$\Delta N = \min\{N\lambda L_f, N\}$$

where  $N$  is the number of nodes in the system,  $\lambda$  denotes the traffic arrival rate, and  $L_f$  is the duration of one superframe. With the randomized slotted Aloha mechanism, if there are  $M$  basic slots on the control channel, the probability for a successful contention is

$$p = \left(1 - \frac{1}{M}\right)^{\Delta N - 1}$$

With a maximum of  $BK$  times retry, the probability of successful access is

$$P_s = \sum_{i=1}^{BK} (1-p)^{i-1} p$$

To guarantee at least 90% successful access on account of  $\Delta N = 20$ , we can get the relation between  $BK$  and  $M$ :

$BK$	5	4	3
$M$	20	24	31

# Frame Structure Flexibility

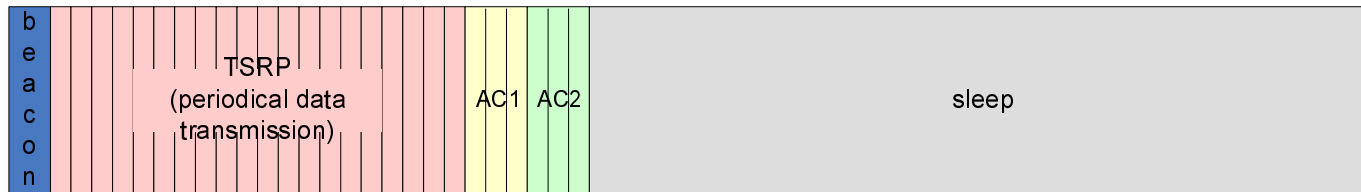

Only periodical traffic (typical for medical application)



Only bursty traffic (typical for CE application)



No active traffic

Traffic-specific data channels are necessary to facilitate adaptive control channels.

- Adaptive tuning of the size of ac1 and ac2 channels  
→ Scalability of the network, resource efficiency
- On-demand regulation of the length of data channels  
→ Energy efficiency of the master node, resource efficiency

# Duty Cycle Illustration

In this example, the medical node has periodic data transmission. The CE node has bursty traffic.

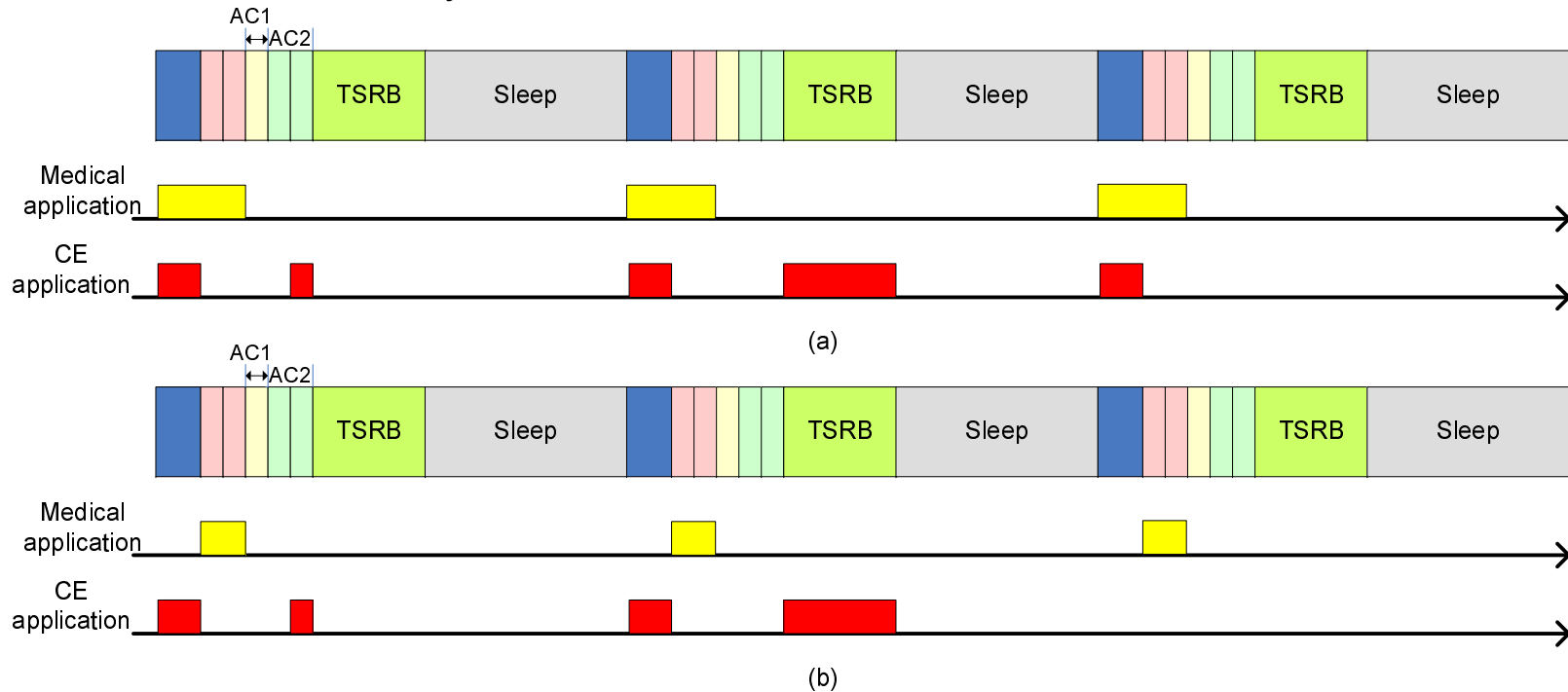

(a) Sensor nodes listen to the beacon for synchronization in every frame.

(b) If clock drift allows, sensor nodes listen to beacon only when it expects information from the master node. *(energy efficiency enhancement)*

# Key Features of Priority-guaranteed MAC

## → Application-specific control channels

Access contention is constrained within the same application class.  
Priority guarantee can be provided to medical application.

## → Separation of data and control channels

Collision happens only to small control packets.  
High data rate service can be supported.

## → Adaptive control channel design

Control channel size is adapted to the application scenario.  
Scalability can be facilitated.

## → Traffic-specific data channels

Periodic traffic can keep fixed duty cycle without being aware of adaptive control channel size.  
Energy efficiency enhancement can be achieved by neglecting some beacon signals.



# Performance Comparison

# Simulation Setup

TI cc2420 is adopted as the energy model for the sensor nodes. PHY layer parameters are calculated with regards to IEEE 802.15.4. Traffic arrival resorts to Poisson arrival process. Packet size is indicated by the number of backoff timeslots ( $0.32 \text{ ms} * 250\text{bps} = 80 \text{ bits}$ ).

Physical data rate	250 kbps
Number of CBR traffic nodes	2
CBR traffic data rate	10 kbps
Number of medical nodes	3 ECG nodes
Medical traffic data rate	2.4 kbps
Number of bursty traffic nodes	1-20
Frame length	61.44 ms
Beacon duration	3.84 ms
Bursty traffic arrival rate $\lambda$	1, 20 (packet per second)
Length of bursty packet	fixed (12 backoff periods duration)
Maximum number of backoff	5
Length of control channels in priority-guaranteed MAC	AC1: 1 backoff periods
	AC2: 31 backoff periods
IEEE 802.15.4 specified parameters	SO = 2
	BO = 2
	MinBE = 3
	MaxBE = 5

# Simulation Results:(1) Power Consumption

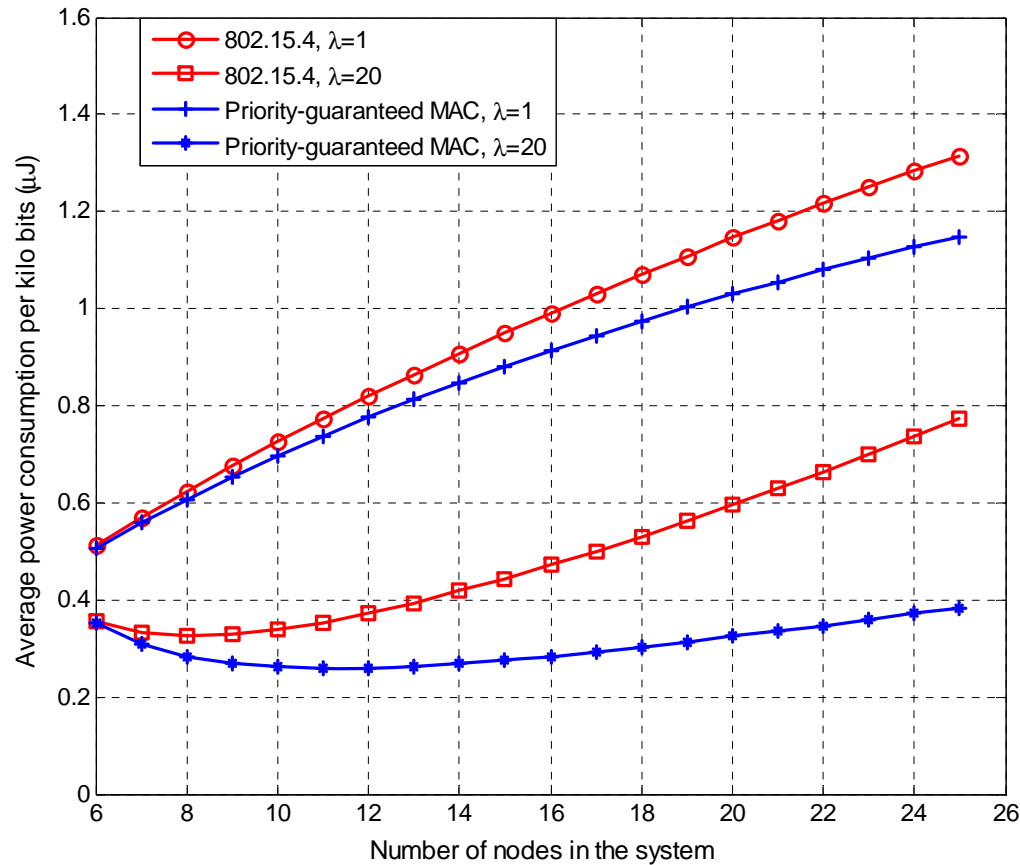

Comparison of average energy consumption per kilo bits ( $\lambda$  in packet/second)

*Significant improvement with priority-guaranteed MAC on energy efficiency!*

## (2) Throughput of Bursty Traffic

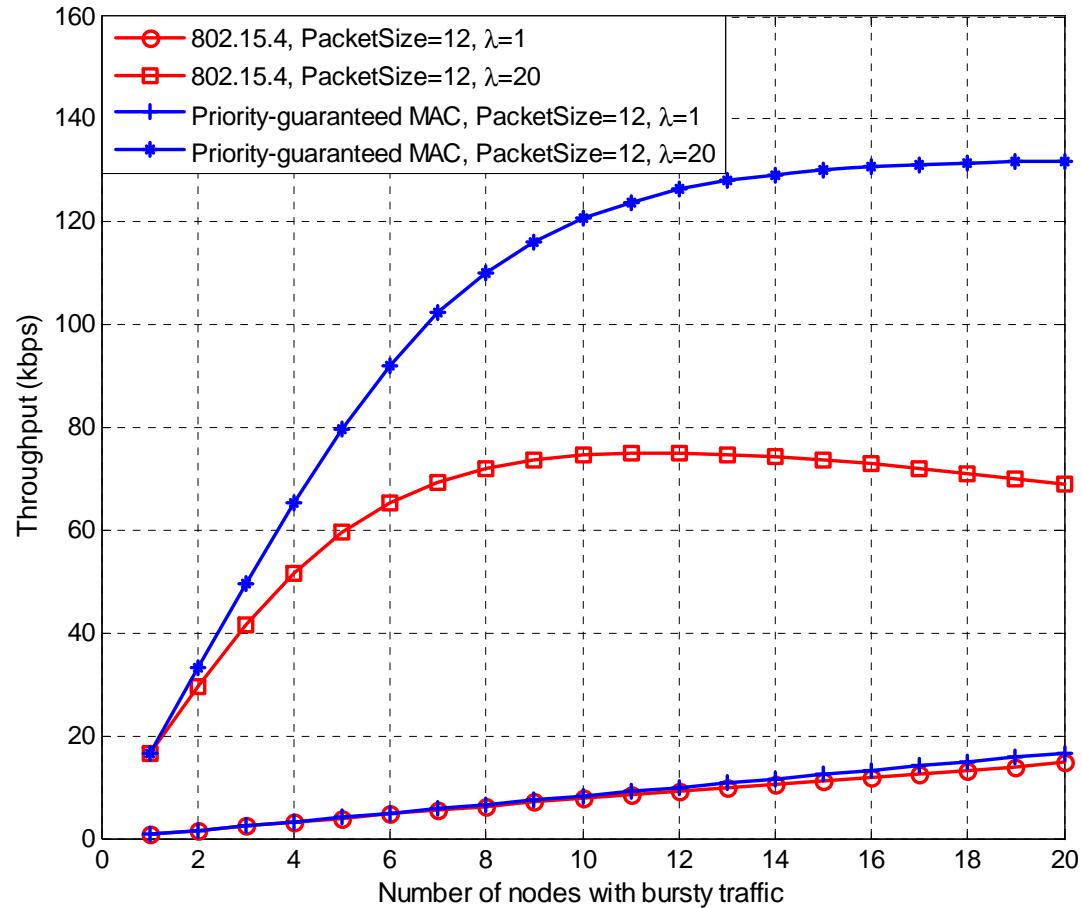

*Significant improvement with priority-guaranteed MAC on throughput!*

# (3.1) Channel Access Latency (node-initiated uplink, bursty traffic)

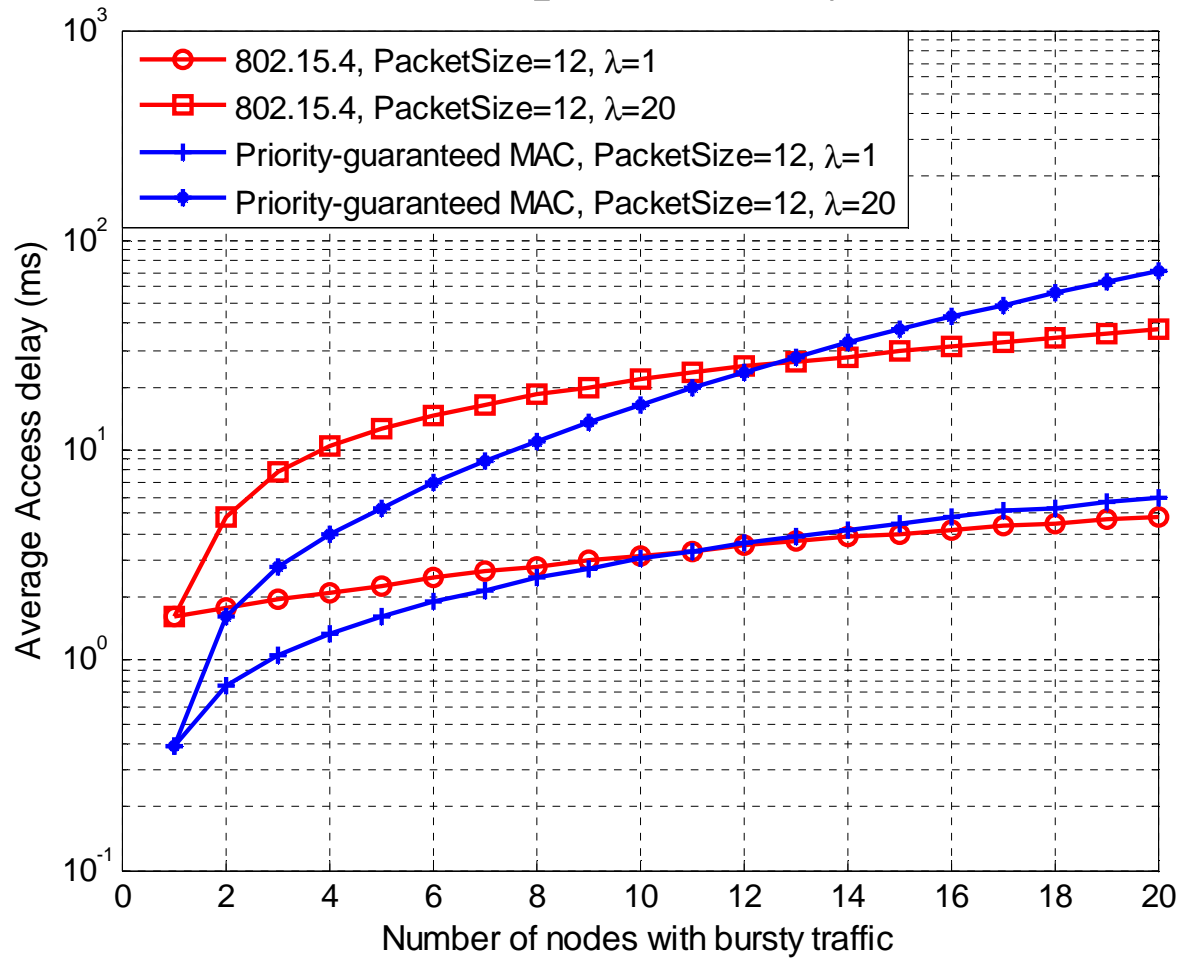

*Delay performance of priority-guaranteed MAC deteriorates with increase of traffic load!*

## (3.2) Channel Access Latency

(node-initiated uplink, medical traffic)

Similarly, access latency of *medical* application can be deduced with the *arrival rate of resource requests* and the *control channel length*.

**Much better latency performance can be expected for medical application.**

- The *resource request* happens at the beginning of periodic data monitoring with *a low arrival rate*. (*medical application is typically of periodic traffic.*)
- *More slots* can be reserved on the control channel (*AC1*) for medical applications. (*Referring to the control channel design, packet collision is determined by the number of requests and the control channel size.*)

When the radio resource is really limited, algorithms can be easily applied at the master node to allocate resource to the medical application with higher priority.

### (3.3) Access Latency (requested uplink or downlink)

If the uplink is requested by the master node or it is a downlink, the latency of link set-up depends on:

→ Frame length

→ How often the node listens to the beacon

**However,**

for medical nodes, especially implanted medical nodes, frequent beacon listening is not desired.

For life-critical medical nodes, to achieve both **energy efficiency maximization** and **latency minimization** confronts a contradiction.

**Therefore, we need a complementary solution instead of resorting only to the regular MAC frame structure!**

# Combined Solution to Emergent Medical Applications



# Application Scenarios of the Life-critical Medical Nodes

1. Date request from the master node  
The doctor wants to check the real time information.
2. Periodic data transmission  
Regular symptom monitoring.
3. Sensor-initiated data transmission  
Emergent uplink initiated by abnormal symptom.
4. User-initiated data transmission  
Emergent uplink initiated by user instruction.

In order to satisfy very high latency requirement ( $\ll 1s$ ),

For scenarios 1 and 2: How to wake up the sensor node promptly?

For scenarios 3 and 4: How to acquire the uplink resource promptly?

# Solution to Emergent Medical Applications

## Combined Solution

- **Wakeup receiver enabled medical nodes**
- **Priority-guaranteed MAC frame structure**

### Master node initiated medical links

- The information of uplink channel configuration is included in the wakeup packet, and hence the medical node can set up the link promptly.

### Sensor node initiated medical links

- If the link is initiated by the sensor node, the fast access can resort to
  - ✓ Priority-guaranteed MAC frame structure, which facilitates dedicated access control channel for the medical application
  - ✓ Wakeup radio

## Q&A

- Q1: How to make a choice between the two uplink access schemes?
  - It depends on the channel of the wakeup radio is separated from the channel of the main radio or not. If the wakeup radio does not have a dedicated channel, the wakeup message from the sensor nodes might be completely ruined by the strong interference from other applications.
  
- Q2: Does CE node need a second wakeup receiver?
  - It depends on the latency requirement. For applications with loose latency requirements, cycled main radio (with a low duty cycle) might be a better solution than the separate wakeup receiver. The detailed analysis will be given in the next section.

# Summary

## Summary of MAC Proposal

- Combination of **wakeup receiver** and **priority-guaranteed MAC protocol** provides high energy-efficiency and prompt downlink and uplink access for medical applications.
- **Application-specific control channels** in priority-guaranteed MAC enable QoS differentiation.
- **Collision-free data channel** improves energy-efficiency for high speed CE applications.
- **Adaptive frame structure** provides high flexibility and scalability.
- Dedicated control channels **facilitate complex signaling exchange** for multi-hop extension.

# Summary with regards to Comparison Criterion

## QoS

Different requirements are imposed by the two types of applications when gauging the quality-of-service (QoS) provided by the MAC proposal:

- **Throughput of CE application** → improved with collision-free data channel
- **Access latency** → guaranteed by adaptive control channel design and the wakeup radio enhancement
- **Priority of life-critical medical application** → guaranteed by the application-specific control channel

With the priority-guaranteed MAC and the wakeup radio enhancement, QoS is satisfied in an energy-efficient way.

# Scalability

Because of the adaptive control channel design and the on-demand data channel allocation, the priority-guaranteed MAC is featured by providing high scalability to different node densities and data rates in a most resource and energy efficient way.



# Topologies to Be Supported

Depending on the application scenarios, different topologies are to be supported by the combined MAC:

- ◆ **Priority-guaranteed MAC** → star, cluster tree, peer-to-peer (P2P)
- ◆ **Wakeup radio** → star, cluster tree, P2P

– The beacon enabled priority-guaranteed MAC is suitable for the network with a central controller, such as the star topology or the cluster tree. As explained in IMEC's narrow band proposal part 1, DSSS is to be used for improved robustness. Therefore, in cluster tree topology, **different spreading codes can be applied to different clusters** to suppress inter-cluster interference.

Because of the dedicated control channel, the priority-guaranteed MAC can also support the P2P topology. Thus all the sensor nodes should listen to the control channel instead of only the master node.

– The wakeup radio can also support all the three topologies. The possible complexity arises from the wakeup receiver design of the cluster head.

## Broadcast and Multicast

Broadcast and multicast can be easily supported by both priority-guaranteed MAC and the wakeup radio enhancement in this narrowband solution.

By defining the broadcast (or multicast) address, the sensor node can recognize a certain broadcast (or multicast) packet from the packet head.

In the wakeup radio scheme, minor complexity might be introduced to the address detection part.

# Part 2

# Wakeup Radio Details

IMEC-NL

May, 2009

## Outline of MAC Part 2

- Wakeup Radio Proposal
  - Motivation
  - Dual Radio System
  - Wake-up Receiver
  
- Applicability Analysis
  - Analytical Model Formulation
  - Analytical Results and Simulation Validation
  - Energy Efficiency Enhancement
  - Extended Discussion

# Wakeup Radio Proposal

# Wakeup Radio -- Why?

**Lifetime extension becomes the bottleneck of sensor networks.**

## Two solutions:

- **Power efficient MAC protocol design (protocol-based duty cycle control)**  
tradeoff between power efficiency and latency
- **Low power circuit design**  
limited improvement due to expected functionality (whole transceiver)

## The third solution: *Wakeup radio*

- Wakeup radio monitors the channel continuously → latency requirement
- Main radio is waked up only when necessary → power efficiency requirement

# Dual-Radio System

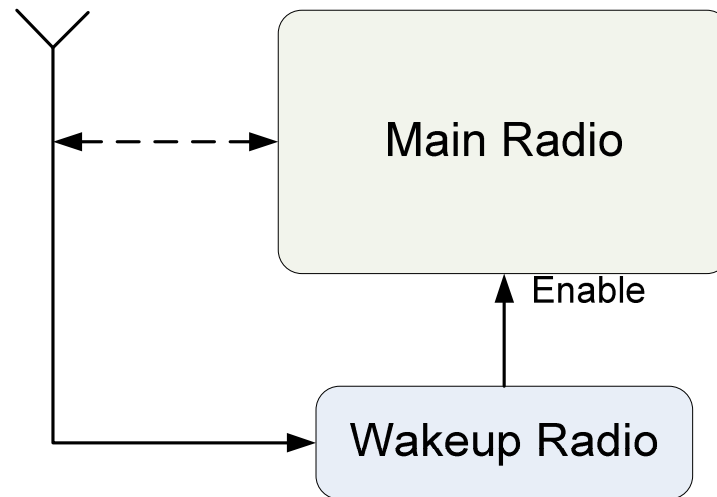

Typical application scenarios of dual-radio system:

- Non-beacon mode
- Emergency/on-demand communication
- Low traffic activity
- Ultra low power consumption

# Dual Radio: WuRx Enabled WBAN Communication (1)

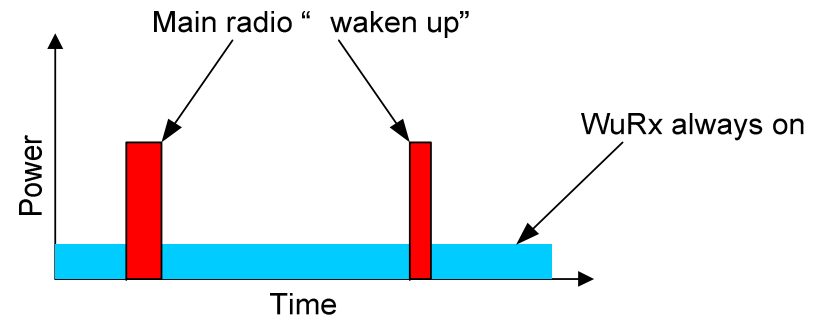
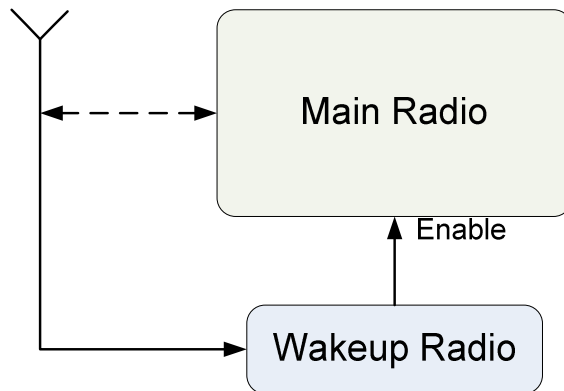

- Ultra-low power wake-up receivers (WuRx):
  - A bit-rate scalable (10 kbps – 1 Mbps) OOK wake-up receiver is used to monitor the channel and to identify the wake-up calls.
  - Fits with asymmetric links → strong wake-up trigger signals → low cost and low power wakeup receiver for body area network nodes.
  - Always on and power up the main radio when needed, aiming at two QoS requirements: low access latency and low energy consumption.



# Dual Radio: WuRx Enabled WBAN Communication (2)

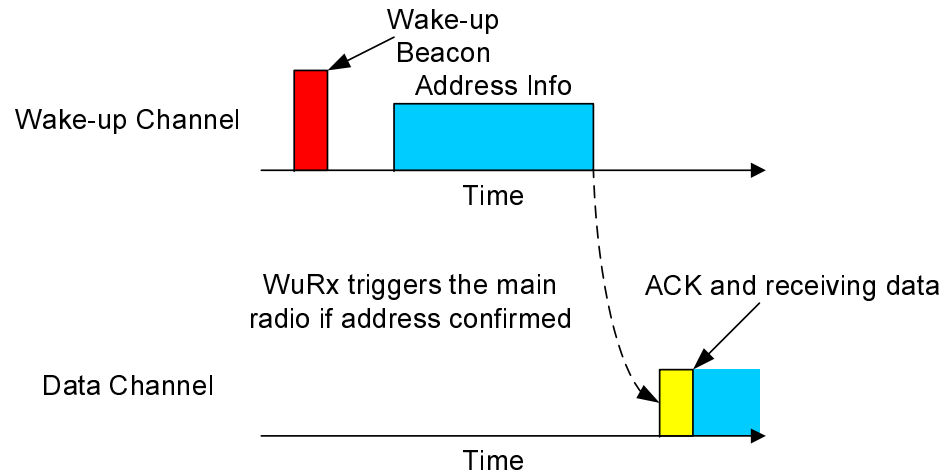
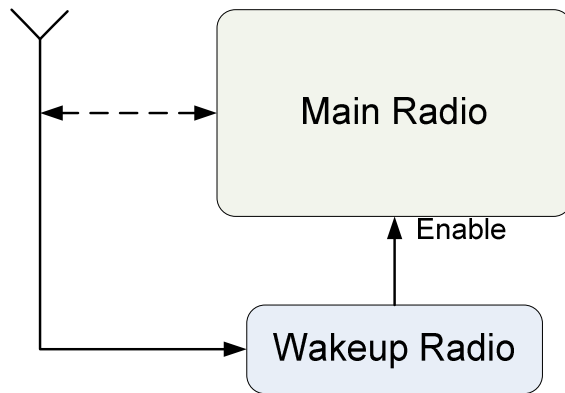

**Dual-radio (high performance main radio TRX + ULP WuRx) architecture fits perfectly with event-driven applications:**

- Minimize access latency;
- Simplify protocol design;
- Reduce power consumption;

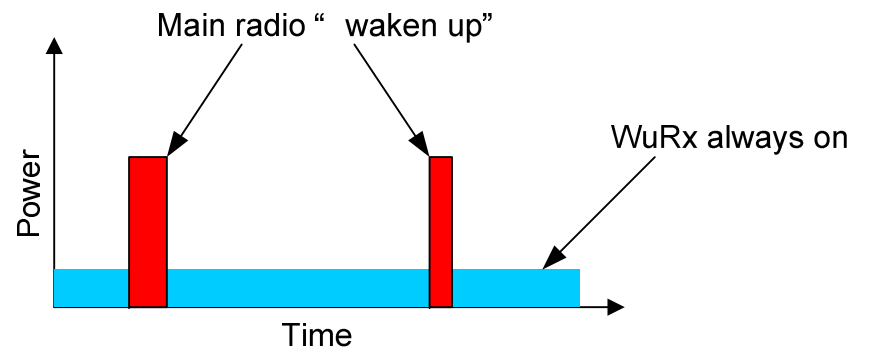

## Dual Radio: WuRx Enabled WBAN Communication (3)

Dual-radio architecture is superior in that:

- Power consumption of data communication scales with network traffic;
- Relaxed requirements for synchronization ;
- Low access latency;
- Relaxed power budget for main radio;

But :

- Trade-offs between ULP and performance – could be solved by proper Tx/Rx link-budget;
- WuRx sets a lower-bound of power consumption in idle state – could be mitigated by applying duty-cycling to the WuRx;

**Co-optimization of MAC/PHY layer is critical in fully exploiting the flexibility offered by dual-radio architecture**

## Wakeup Radio -- How?

Challenge: extremely low power budget (<50 uW)

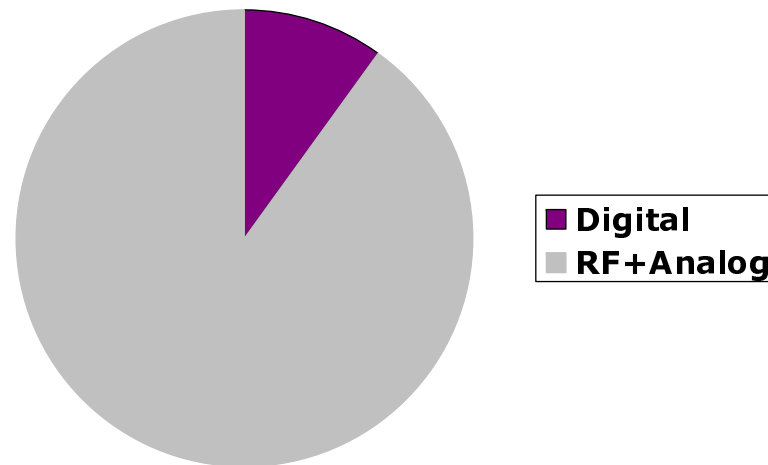

- Less than 50 uW power consumption allowed for RF and analog part.
- A few uW allowed for the digital baseband.

***Tradeoff between power consumption and wakeup accuracy (miss detection and false alarm).***

# WakeUp Packet Structure

The structure of the wakeup packet can be of two options, depending on the link info is included or not.

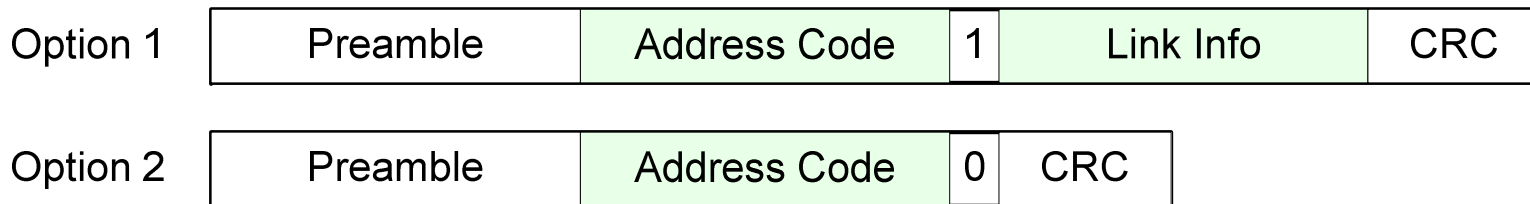

- Preamble is used to implement amplitude estimation and bit synchronization.
- The optional link info part can *piggyback some control/data bits* or *include the information about the main radio*, such as channel configuration, modulation scheme, sub-component selection (in case of multiple sensors supported by the same radio).
- The colored parts are Manchester encoded for improved robustness.
- The address code is the identification of a certain node, or a group of nodes in case of broadcast and multicast. Different sequences can be used as the address codes: PN sequence or Walsh-Hadamard sequence (better cross-correlation performance).

# Chance of Miss Detection and False Alarm

Different address codes are tested in the simulation to demonstrate the performance on miss detection and false alarm.

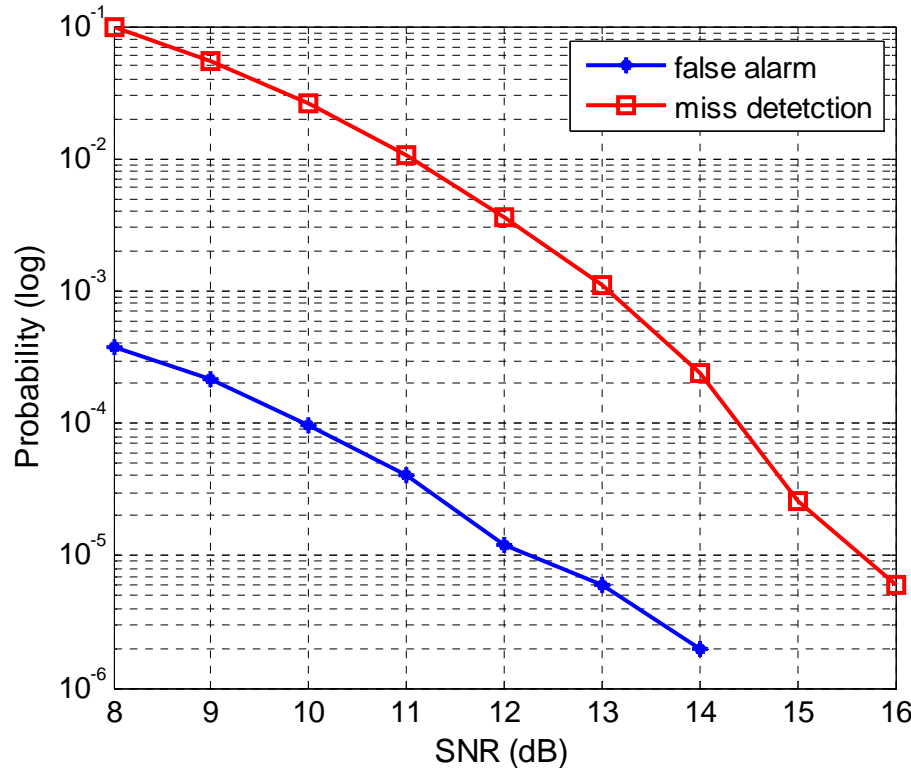

Case 1: PN code is used as address code

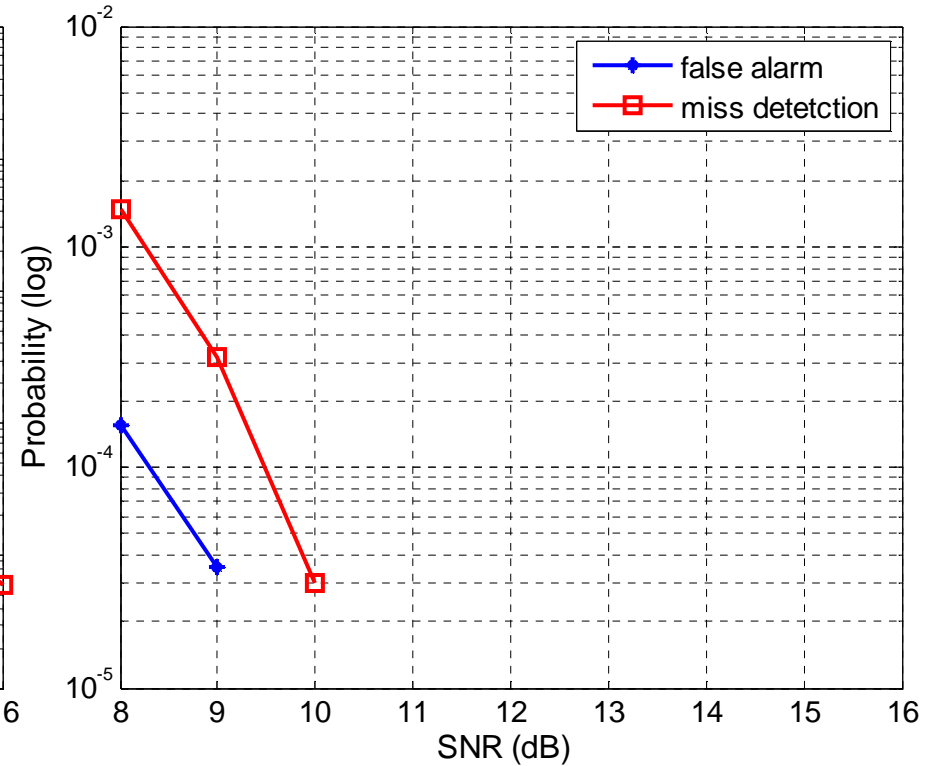

Case 2: Walsh-Hadamard sequence is used as address code

Walsh-Hadamard sequence is featured by good cross-correlation performance.

# Applicability Analysis

→ Analytical Model Formulation

# MAC Design for Sensor Networks

Conventionally, the performance of MAC protocol can be evaluated by

- Throughput (radio resource efficiency)
- Energy efficiency
- Access latency

**For sensor networks, what is crucial?**

- Throughput ?
- Energy efficiency
- Access latency

# Analytical Model Formulation

Latency requirement

---



Energy efficiency  
maximization

*Two schemes are compared:*

*cycled main radio and separate wakeup radio.*

Two parameters are adopted to characterize wakeup scheme differentiation:

→ Regular channel monitoring

$P_{\text{monitor}}$  : average power consumption of the node in the channel monitoring state

→ Wakeup signal exchange

$E_{\text{wu}}$ : average energy consumed to wake up an intended receiver and to build up the data link



## Basic Assumptions

1. Wakeup packet and ACK packet take the same transmission delay.
2. Propagation delay is neglectable.
3. Startup delays for the main radio and the wakeup receiver from sleep mode to active mode are less than the latency requirement.

# Analysis Parameters

Symbol	Explanation
$T_{main\_active}$	active listening period of the main radio
$T_{main\_sleep}$	sleep period of the main radio
$T_{s2a}$	startup delay from sleep mode to active mode
$T_{sft}$	settling time due to mode shift between transmission mode and receiving mode
$\eta$	duty cycle of the one-channel wakeup scheme
$T_{Lmax}$	maximum acceptable latency of the application
$T_{wu}$	transmission delay of wakeup packet on the main radio
$P_{rx}$	power consumption of main radio in receiving or channel monitoring state
$P_{tx}$	power consumption of main radio in transmission mode
$P_{sleep}$	power consumption of main radio in sleeping mode
$P_{s2a}$	power consumption during $T_{s2a}$ period
$P_{sft}$	power consumption during $T_{sft}$ period
$P_{wu}$	power consumption of wakeup receiver in active mode

# Idealized Analysis (1)

Additional assumption: Perfect channel and no collision

Step 1: To determine the duty cycle of the main radio

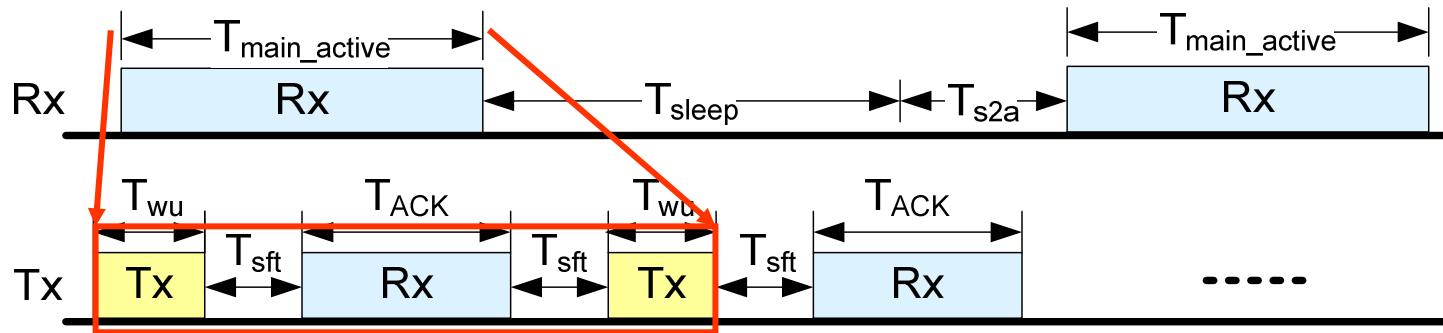

To guarantee that the receiver's active period can cover a complete wakeup packet, it should meet the following requirement:

$$T_{main\_active} \geq 2T_{wu} + T_{ACK} + 2T_{sft}$$

With basic assumption (1), we get  $T_{wu} = T_{ACK}$  by further assuming that the receiver will send the ACK immediately after detecting a correct wakeup packet.

## Idealized Analysis (2)

Given the constraint of maximum access latency, we get

$$\begin{cases} T_{main\_active} \geq 3T_{wu} + 2T_{sft} \\ T_{main\_sleep} + T_{s2a} \leq \underline{T_{Lmax}} - (4T_{wu} + 3T_{sft}) \end{cases}$$

Therefore, the minimum duty cycle of the cycled receiver is

$$\eta_{\min} = \frac{3T_{wu} + 2T_{sft}}{T_{Lmax} - (T_{wu} + T_{sft})}$$

**Step 2:** To deduce the power consumption of channel monitoring in the cycled main radio scheme

$$P_{main\_dc\_monitor} = \eta \left( P_{rx} + \frac{T_{s2a}}{3T_{wu} + 2T_{sft}} (P_{s2a} - P_{sleep}) \right) + (1 - \eta) P_{sleep}$$

# Idealized Analysis (3)

**Step 3:** To derive the energy consumption related to wakeup signal exchange in the cycled main radio scheme

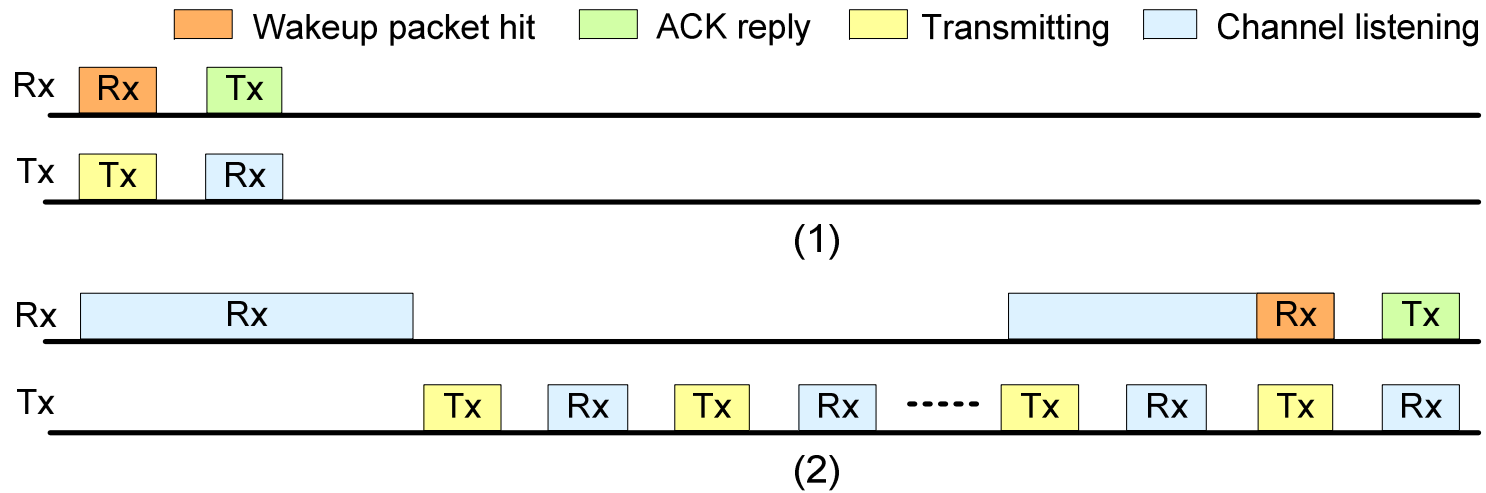

$$E_{main\_dc\_wu\_min} = 2(E_{s2a} + E_{wuTX} + E_{wuRX} + E_{sft})$$

$$E_{main\_dc\_wu\_max} = 2E_{s2a} + 3E_{wuRX} + E_{wuTX} + 2T_{sft}P_{rx} + E_{sft} + \frac{E_{wuTX} + E_{wuRX} + 2E_{sft}}{2(T_{wu} + T_{sft})} T_{Lmax}$$

➔

$$E_{main\_dc\_wu} \approx \frac{1}{2}(E_{main\_dc\_wu\_min} + E_{main\_dc\_wu\_max})$$

## Idealized Analysis (4)

**Step 4:** To derive the power consumption of channel monitoring state in the separate wakeup radio scheme

$$P_{wu\_monitor} = P_{wu} + P_{sleep}$$

**Step 5:** To derive the energy consumption related to wakeup signal exchange in the separate wakeup radio scheme

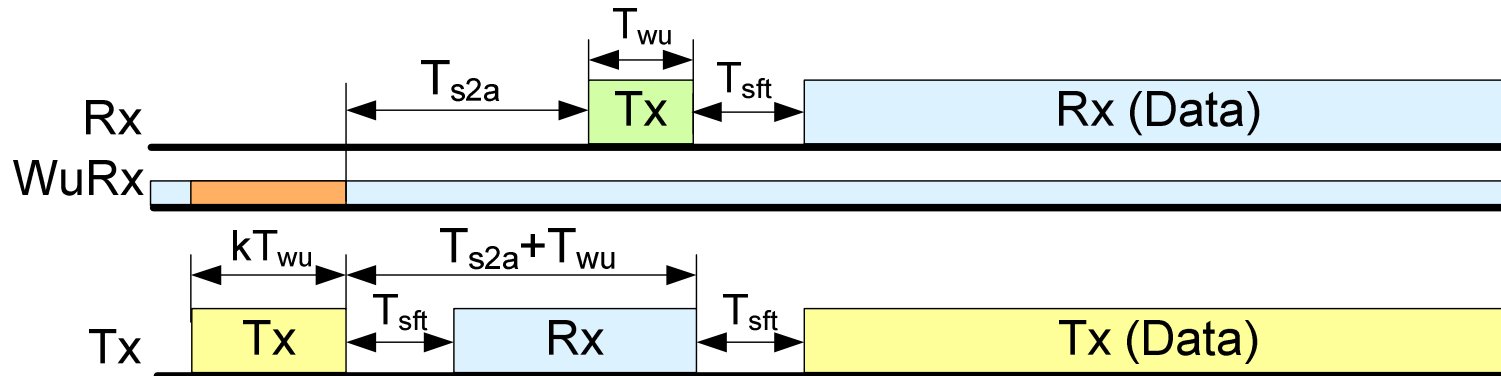

$$E_{wu\_wu} = 2E_{s2a} + (k + 1)E_{wuTX} + E_{sft} + (T_{s2a} - T_{sft})P_{rx} + E_{wuRX}$$

Here  $k$  is used to approximate the overall effect on the energy consumption used to send the same size wakeup packet at a lower data rate .

## Idealized Analysis (5)

**Step 6:** Compare the two performance parameters with different wakeup schemes

$$\left\{ \begin{array}{l} P_{main\_dc\_monitor} \geq P_{wu\_monitor} \\ E_{main\_dc\_wu} \geq E_{wu\_wu} \end{array} \right.$$



$$\left\{ \begin{array}{l} \frac{P_{rx} + \frac{T_{s2a}}{3T_{wu} + 2T_{sft}}(P_{s2a} - P_{sleep}) - P_{sleep}}{P_{wu}} \geq \frac{1}{\eta} \\ T_{Lmax} \geq \frac{(4k-2)E_{wuTX} + (4T_{s2a} - 6T_{wu} - 8T_{sft})P_{rx} - 2E_{sft}}{E_{wuTX} + E_{wuRX} + 2E_{sft}}(T_{wu} + T_{sft}) \end{array} \right.$$

 $T_{Lmax}$

## Non-ideal Case (1)

- Consider that the wakeup packet might be impaired due to packet collision or the noisy channel in a real system.
- Wakeup packet with the separate wakeup radio scheme is more vulnerable.

Probability of miss detection:  $P_{miss}$

Probability of false alarm:  $P_{false}$

→ Due to the probability of miss detection, the transmitter might send the wakeup packet several times in order to wakeup the receiver successfully. The expectation of the number of wakeup packet transmission is  $\sum_{l=1}^L P_{miss}^{l-1}$

→ The probability of false alarm will introduce additional power consumption in the channel monitoring period.



## Non-ideal Case (2)

Compare the updated energy efficiency parameters of the separate wakeup radio scheme with the parameters of the cycled main radio scheme

$$\left\{ \begin{array}{l} P_{main\_dc\_monitor} \geq P_{wu\_monitor} \\ E_{main\_dc\_wu} \geq E_{wu\_wu} \end{array} \right.$$



$$\left\{ \begin{array}{l} \frac{P_{rx} + \frac{T_{s2a}}{3T_{wu} + 2T_{sft}}(P_{s2a} - P_{sleep}) - P_{sleep}}{P_{wu} + P_{main\_false}} \geq \frac{1}{\eta} \\ T_{Lmax} \geq 4 \left( \frac{\frac{E'_{2c\_src}}{p_{suc}} - E_{s2a} - \frac{1}{2}E_{wuTX} - \frac{5}{2}E_{wuRX} - \frac{3}{2}E_{sft} - T_{sft}P_{rx}}{E_{wuTX} + E_{wuRX} + 2E_{sft}} \right) (T_{wu} + T_{sft}) \end{array} \right.$$

## Applicability Analysis

→ Analytical Results and Simulation Validation

# Typical Parameters

Nordic nRF24L01 is adopted as the energy model for the main radio. Power consumption of the wakeup receiver is assumed to be 50 uW. Typical values of scenario parameters are shown in the following table.

Parameters	Typical value
wakeup packet size	200 bits
data rate on the main radio	1Mbps
data rate on the second wakeup channel	200 kbps
$k$	4
Number of users in the system $N$	3, 9, 15
$\lambda$ (packet/second)	$10^{-2}$ , $10^{-1}$ , 1, 10
$T_{wu}$	0.2 ms
$T_{s2a}$	1.63 ms
$T_{sft}$	130 us
$\delta$	2
$P_{miss}$ , $P_{false}$	0.1
$L$	3

## Analytical Results

Given the typical parameters, the latency requirement of a certain application that makes the separate wakeup radio scheme more favorable can be calculated numerically.

For idealized analysis,

$$\left\{ \begin{array}{l} \frac{P_{rx} + \frac{T_{s2a}}{3T_{wu} + 2T_{sft}}(P_{s2a} - P_{sleep}) - P_{sleep}}{P_{wu}} \geq \frac{1}{\eta} \quad , \text{ with } \eta = \frac{3T_{wu} + 2T_{sft}}{T_{Lmax} - (T_{wu} + T_{sft})} \\ T_{Lmax} \geq \frac{(4k - 2)E_{wuTX} + (4T_{s2a} - 6T_{wu} - 8T_{sft})P_{rx} - 2E_{sft}}{E_{wuTX} + E_{wuRX} + 2E_{sft}}(T_{wu} + T_{sft}) \end{array} \right.$$



$$3.9 \text{ ms} \leq T_{Lmax} \leq 697 \text{ ms}$$

# Simulation Validation

Monte Carlo simulations are carried out to verify the analytical results.

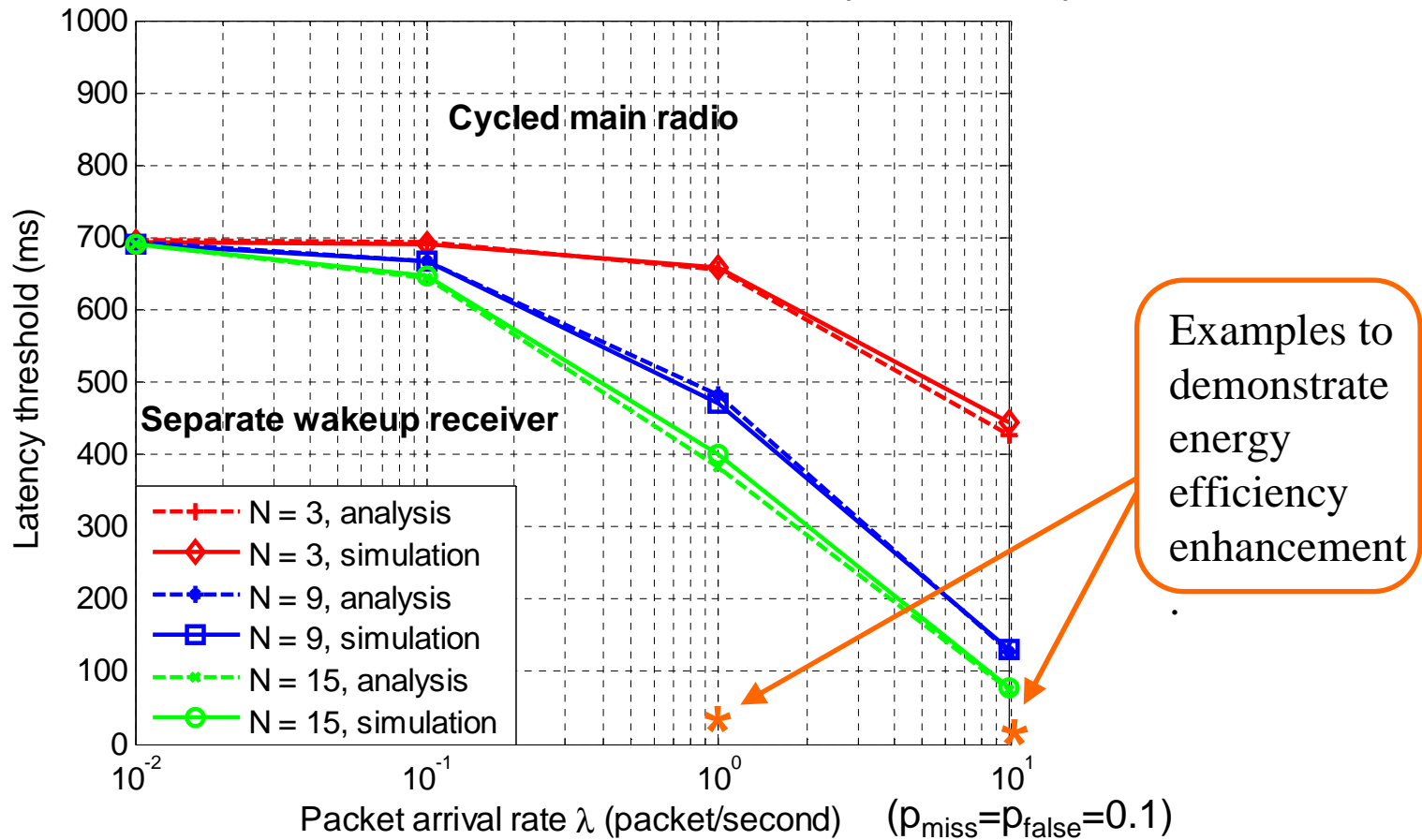

Energy efficiency maximization w.r.t. latency requirements in different network scenarios.

# Applicability Analysis

→ Energy Efficiency Enhancement

# Energy Budget of Wake-up Assisted Radio (1)

Parameter name	Explanation
$T_{wake}$	Switching duration: Sleep $\rightarrow$ Standby
$T_{set}$	Switching duration: Settling period when switching to Rx or Tx.
$P_{sleep}$	Power consumption in sleep mode.
$P_{standby}$	Power consumption in standby mode.
$P_R$	Power consumption in Rx mode.
$P_T$	Power consumption in Tx mode.
$P_{Rset}$	Power consumption when switching to Rx mode.
$P_{Tset}$	Power consumption when switching to Tx mode.
$P_{wake}$	Power consumption when switching between sleep and standby mode.
$\Delta P_x$	Power increase in mode x compared to sleep mode $P_x - P_{sleep}$
$k$	Length of minimal packet in bits. Used for: sync, ACK, WUC
$R_b$	Bit rate of main radio

**Radio Control Parameters**

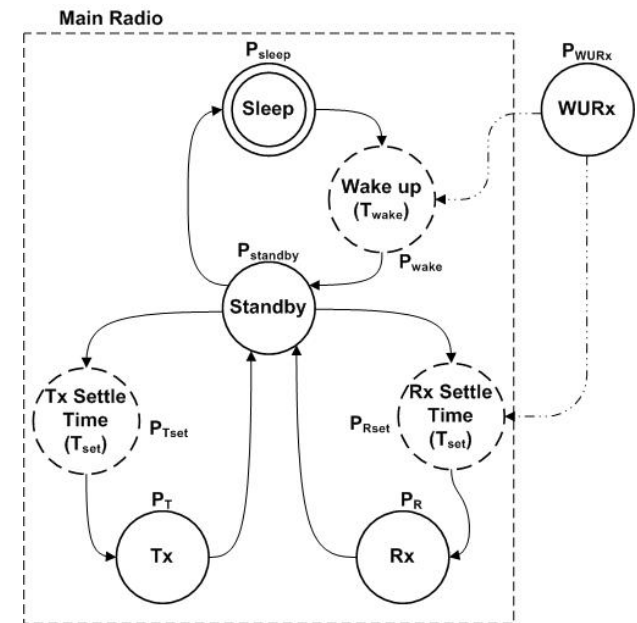

**Radio Control State Diagram**

## Energy Budget of Wake-up Assisted Radio (2)

Three schemes are compared:

- Synchronized Duty-Cycled TDMA MAC scheme
- Wake-up Assisted Radio
- Unsynchronized Duty-Cycled MAC scheme (e.g. X-MAC)

<b>Parameter</b>	<b>Value</b>
<b>Number of nodes</b>	<b>12</b>
<b>Power Wake-up Radio</b>	<b>50 <math>\mu</math>W</b>
<b>Wake-up and ACK packet size</b>	<b>34 bits</b>
<b>Wake-up false positives and negatives</b>	<b>&lt; 1 %</b>
<b>Max. wake-up attempts</b>	<b>1</b>



## Energy Budget of Wake-up Assisted Radio (3)

Application is Vital-Signals-Monitoring. Described in 15-08-0407-06-0006-tg6-applications-summary.doc as wearable BAN Z004

Type	Packet rate ( $\lambda_R$ )	Latency
Blood pressure sensor	0.0167	25ms
Thermometer	1	25ms
Pulse sensor	1	25ms
Respiratory sensor	10	8.3ms/25ms
ECG	10	8.3ms/25ms

wearable BAN Z004

# Energy Budget of Wake-up Assisted Radio (4)

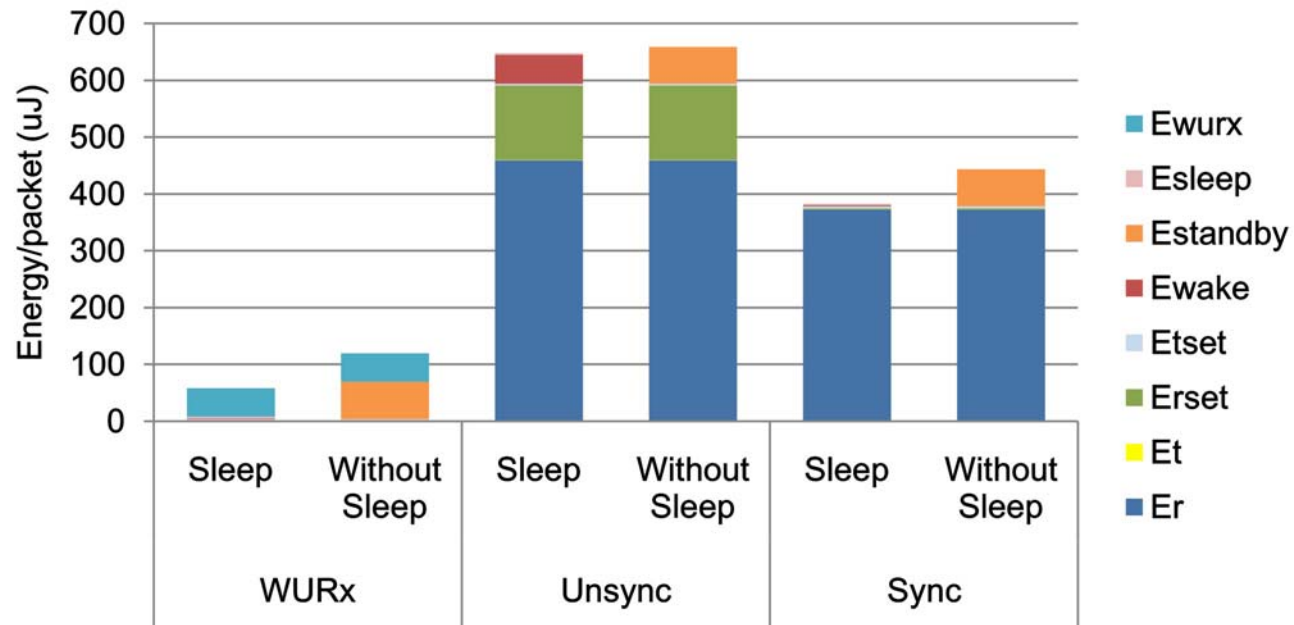

Energy dissipation per received packet per node  
 (*Received packets/s* = 1,  $T_{Lmax} = 25$  ms)

# Energy Budget of Wake-up Assisted Radio (5)

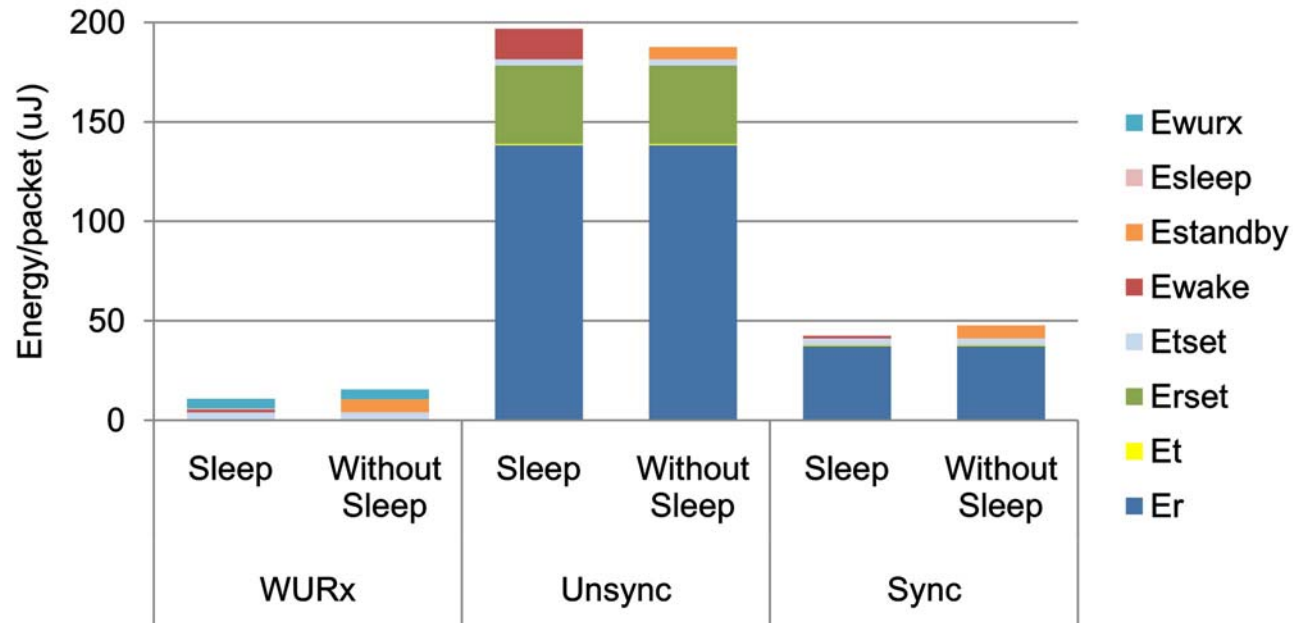

Energy dissipation per received packet per node  
 (*Received packets/s* = 10,  $T_{Lmax}$  = 8.3 ms)

# Applicability Analysis

→ Extended Discussion

# Duty Cycled Separate Wakeup Radio

Extended analysis is carried out to apply duty cycle control to the separate wakeup receiver aiming for non-time-critical applications.

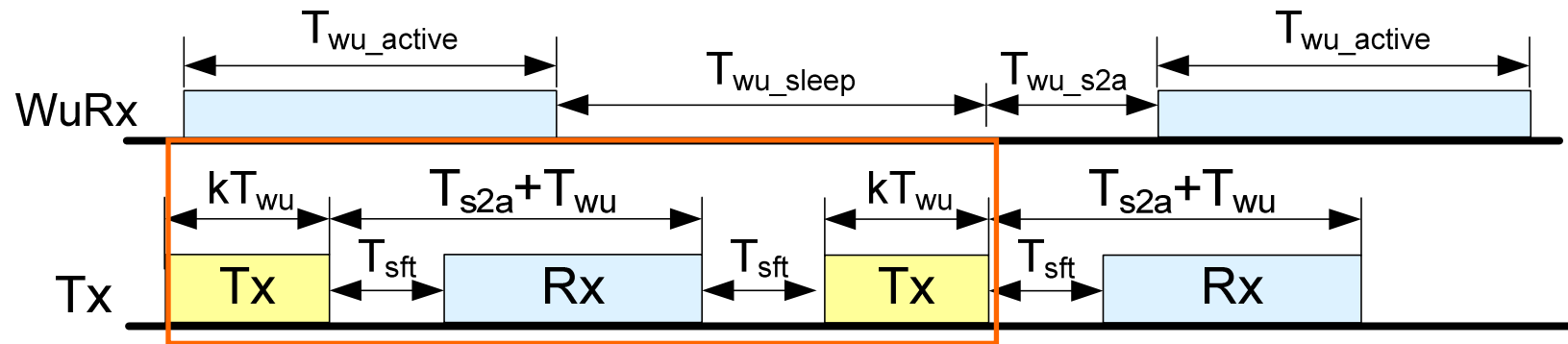

To guarantee the latency requirement from the application, we get

$$\begin{cases} T_{wu\_active} \geq (2k + 1)T_{wu} + T_{s2a} + T_{sft} \\ T_{wu\_sleep} + T_{wu\_s2a} \leq T_{Lmax} - (2(k + 1)T_{wu} + 2T_{s2a} + T_{sft}) \end{cases}$$



$$\eta_{wu\_min} = \frac{(2k + 1)T_{wu} + T_{s2a} + T_{sft}}{T_{Lmax} - (T_{wu} + T_{s2a})}$$

## Performance Modeling

The two performance measurements are updated for the duty cycled separate wakeup radio scheme in idealized case.

$$\left\{ \begin{aligned}
 P_{wu\_dc\_monitor} &= \eta_{wu} P_{wu} + (1 - \eta_{wu}) P_{wu\_sleep} + \frac{T_{wu\_s2a} (P_{wu\_s2a} - P_{wu\_sleep})}{T_{Lmax} - (T_{wu} + T_{s2a})} + P_{sleep} \\
 &= \eta_{wu} \left( P_{wu} + \frac{T_{wu\_s2a}}{(2k+1)T_{wu} + T_{s2a} + T_{sft}} (P_{wu\_s2a} - P_{wu\_sleep}) \right) + (1 - \eta_{wu}) P_{wu\_sleep} + P_{sleep} \\
 E_{wu\_dc\_wu} &\approx \frac{1}{2} (E_{wu\_dc\_wu\_min} + E_{wu\_dc\_wu\_max})
 \end{aligned} \right.$$

With

$$E_{main\_dc\_wu\_min} = 2E_{s2a} + (k+1)E_{wuTX} + E_{sft} + (T_{s2a} - T_{sft})P_{rx} + E_{wuRX} + E_{wu\_s2a} + P_{wu}T_{wu\_active}$$

$$E_{main\_dc\_wu\_max} = 2E_{s2a} + E_{wuTX} + \frac{kE_{wuTX} + E_{wuRX} + (T_{s2a} - T_{sft})P_{rx} + E_{sft}}{(k+1)T_{wu} + T_{sft} + T_{s2a}} T_{Lmax} + E_{wu\_s2a} + P_{wu}T_{wu\_active}$$

# Latency Threshold

We compare the energy efficiency between the duty cycled main radio scheme and the duty cycled separate wakeup receiver scheme.

$$\left\{ \begin{array}{l} P_{wu\_dc\_monitor} \leq P_{main\_dc\_monitor} \\ E_{wu\_dc\_wu} \leq E_{main\_dc\_wu} \end{array} \right.$$



1. Cost of duty cycle control
2. Wakeup packet impairment

$$\left\{ \begin{array}{l} 1.84ms \leq T_{Lmax} \leq 23.1s \\ T_{Lmax} \geq 1.07ms \end{array} \right.$$

Given that  $T_{wu\_s2a} = 60 \mu s$ ,  $P_{wu\_sleep} = 1.5 \mu W$ , and  $P_{wu\_s2a} = 50 \mu W$ .