

Project: IEEE 802.15 Working Group for Wireless Personal Area Networks (WPANs)

Submission Title: [Panasonic PHY and MAC Proposal to IEEE802.15 TG3c CFP]

Date Submitted: [10 July, 07]

Source: [Taisuke Matsumoto¹, Suguru Fujita¹, Huang Lei², Michael Sim², Yu Zhan Raymond²]

Company [¹ Matsushita Electric Industrial Co., Ltd., ² Panasonic Singapore Laboratories]

Address ¹ [4-12-4 Higashi-Shinagawa, Shinagawa-ku, Tokyo 140-8587, Japan]

² [Blk 1022 Tai Seng Avenue #06-3530, Singapore 534415, Singapore]

Voice: [+81-3-6710-2029¹, +65-6550-5323², +65-6550-5332²]

E-Mail: [matsumoto.taisuke@jp.panasonic.com¹, fujita.suguru@jp.panasonic.com¹,

Lei.Huang@sg.panasonic.com², Michael.Simhc@sg.panasonic.com²,

Raymond.Yuz@sg.panasonic.com²]

Re: [In response to TG3c Call for Proposals (IEEE P802.15-07-0586-02-003c)]

Abstract: [Panasonic PHY and MAC proposal for portable applications]

Purpose: [To be considered in TG3C baseline document.]

Notice: This document has been prepared to assist the IEEE 802.15. It is offered as a basis for discussion and is not binding on the contributing individual(s) or organization(s). The material in this document is subject to change in form and content after further study. The contributor(s) reserve(s) the right to add, amend or withdraw material contained herein.

Release: The contributor acknowledges and accepts that this contribution becomes the property of IEEE and may be made publicly available by 802.15.

Panasonic PHY&MAC Proposal to IEEE802.15 TG3c for Portable Applications

Panasonic Team

Contents

- General Overview
- PHY Layer Design
 - Channelization
 - Frame formats
 - BER and PER performances
- Implementation Feasibility
 - Non-coherent architecture as a simplest radio
- MAC Layer
 - Coexistence among different modulated signals
- Summary

Forward Steps

- Merging with CoMPA is still in progress.
- We also seek further mergers with other parties to enhance the future market capability.

General Overview

- PHY & MAC partial proposal
- Fulfill the UM5 in TG3C UMD
 - File downloading/uploading: typical range is 1m, point-to-point
- PHY layer:
 - Single carrier OOK, BPSK and QPSK modulations
 - Reed-Solomon code mandatory for FEC
- Implementation feasibility:
 - Coherent and Non-coherent architectures
 - Simple hardware design with low power consumption, very suitable for portable devices applications
 - Quick to the market
- MAC layer:
 - Modification based on IEEE802.15.3 centralized MAC
 - Adaptive dual beaconing mode for coexistence

Problems for CE Applications by using Millimeter Wave

- Cost
- Power Consumption
- Shape Factor
- Mass Productivity



Low Complexity is Most Important Factor!

- Killer Application



UM5 can be solved only by using mmW

Application Scenario in UM5

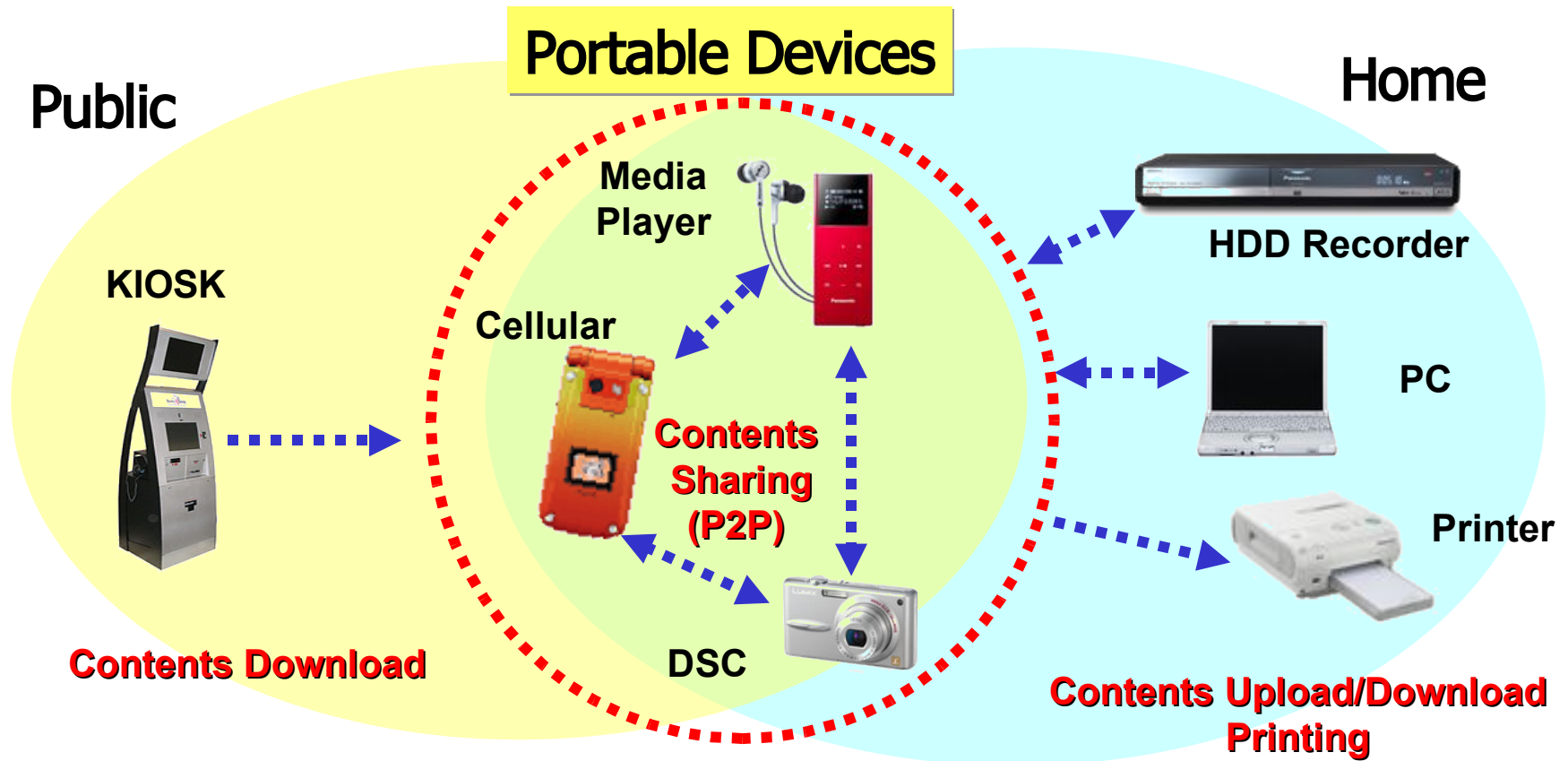

- Requirements from portable devices
 - Low power consumption, Low cost and Compactness

Classified Solutions for UM1 and UM5

- UM1 and UM5 requirements are completely different.
- Suitable solution for each UMs should be chosen.
- Single Carrier with adaptive modulation can support all Application Scenarios

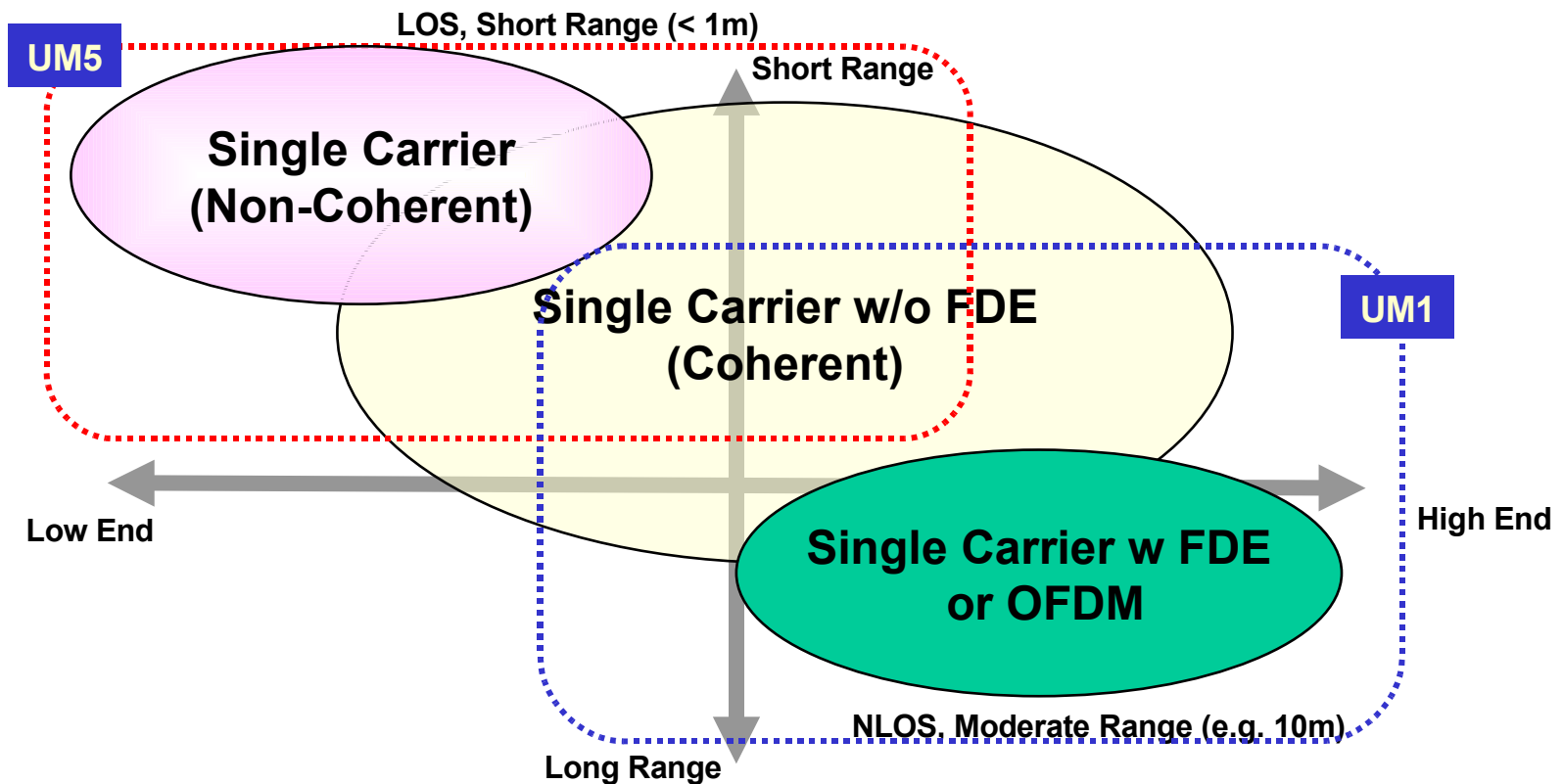

Key Features

- On-Off-Keying (OOK) enables simplest radio architecture to realize lowest cost and fastest time to market
- OOK with RS FEC provides sufficient performances for UM5
- BPSK / QPSK can be an upper compatible system for OOK to support high end applications. It has no significant hardware impacts for BPSK / QPSK transceiver to adopt OOK mode.
- Possibility of adaptive modulated beaconing (coexistence among different modulation systems)

PHY Layer Design

Channelization

Channel Number	Low Freq. (GHz)	Center Freq. (GHz)	High Freq. (GHz)	Nyquist BW (MHz)	Roll-Off Factor
A1	57.200	58.240	59.280	1664	0.25
A2	59.280	60.320	61.360	1664	0.25
A3	61.360	62.400	63.440	1664	0.25
A4	63.440	64.480	65.520	1664	0.25

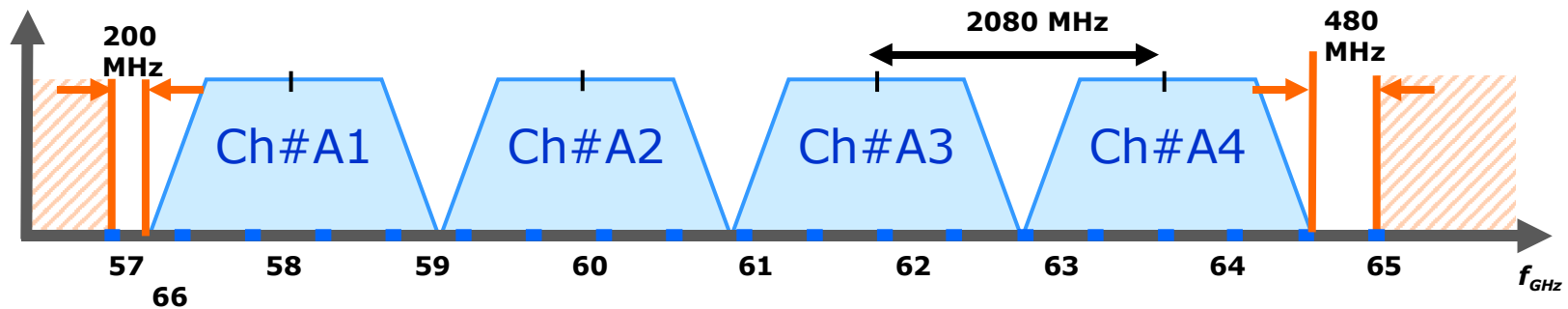

- Support 4 channels over 9GHz bandwidth
- 3-dB bandwidth is 1.664GHz, Channel separation is 2.08 GHz based on 26 MHz cell phone Xtal which is most popular. (Supporting COMPA's original channelization due to implementation simplicity)

Basic Parameters

Modulation Scheme	OOK	BPSK	QPSK
Bits per symbol	1	1	2
Detection	Non-coherent/Coherent	Coherent	Coherent
Outer FEC encoder	Reed Solomon(255, 239)	Reed Solomon(255, 239)	Reed Solomon(255, 239)
Inner FEC encoder	None	None <Optional> Convolutional Code 3/4, 1/2	None <Optional> Convolutional Code 3/4, 1/2
PHY header	Shorten Reed Solomon (32, 16)	Shorten Reed Solomon (32, 16)	
PHY payload data rate	1.5596Gbps	1.5596Gbps <Optional> 1.1697Gbps, 0.7798Gbps	3.1192Gbps <Optional> 2.3394Gbps, 1.5596Gbps

Data Rate Modes

Mode	Modulation	Detection	FEC scheme*	PHY-SAP payload rate [Gbps]**
1.1	OOK	Noncoherent	RS(255,239)	1.5596
1.2	OOK	Coherent	RS(255,239)	1.5596
2	BPSK	Coherent	RS(255, 239)	1.5596
3	QPSK	Coherent	RS(255,239)	3.1192

- *) RS(255,239) is the mandatory FEC codes for payload data. Convolutional codes or LDPC can be added as optional inner codes if concatenated FEC encoding is adopted.
- ***) Cylix prefix (CP) for FDE can be added as option. In the table, it is assumed there is no FDE applied, so $CP = 0$.

Why adopt OOK modulation?

- OOK modulation
 - Very simple circuitry to support above 1Gbps of 15.3c PAR
 - Very low power consumption of non-coherent architecture
 - Sufficient performance over AWGN or nearly AWGN channels
 - Phase noise of local oscillator has no effects on the detection performance
- Very suitable for Kiosk file-downloading and portable P2P applications
 - In those applications, almost Point-to-Point
 - Occurs in short distance
 - Does not need super high rate
 - Power consumption has much higher priority

Preamble Format

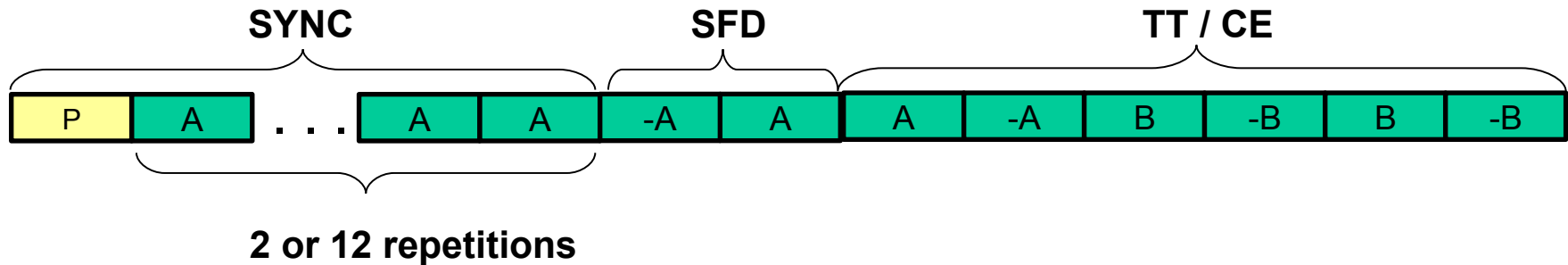

[a, b] is Golay code set as defined on the next slide
 [A, B] is modified Golay code set by change “-1” to “0” at [a, b]
 [-a, -b] is inverting the polarity of [a, b]
 [-A, -B] is interchanging bits “1” and “0” of [A, B]
 P is a sequence of “1 0 1 0 ... 1 0” with alternative “1”&“0”
 All sequences A, B, a, b, P have 128 symbols

SFD is for mode identifier:
 [-A, A] to indicate OOK
 [-A,-A] to indicate PSK

Mode	Symbol Rate [Gsps]	SYNC		SFD	TT/CE	Total Length	
		No of sequence (P)	No. of sequences (A)	No. of sequences (A and -A)	No. of sequences (A,-A,B and -B)	No. of symbols	nsec
HR	1.664	1	12	2	6	2,688	1,615.4
LR	1.664	1	2	2	6	1,408	846.2

128-symbol length Golay Sequence

a

$a_0 a_1 a_2 a_3 a_4 a_5 a_6 a_7 \dots a_{124} a_{125} a_{126} a_{127}$

Element of Golay code <i>a</i>	Value	Element of Golay code <i>a</i>	Value	Element of Golay code <i>a</i>	Value	Element of Golay code <i>a</i>	Value
a_0	1	a_{32}	1	a_{64}	1	a_{96}	-1
a_1	1	a_{33}	1	a_{65}	1	a_{97}	-1
a_2	1	a_{34}	1	a_{66}	1	a_{98}	-1
a_3	1	a_{35}	1	a_{67}	1	a_{99}	-1
a_4	1	a_{36}	1	a_{68}	1	a_{100}	-1
a_5	-1	a_{37}	-1	a_{69}	-1	a_{101}	1
a_6	1	a_{38}	1	a_{70}	1	a_{102}	-1
a_7	-1	a_{39}	-1	a_{71}	-1	a_{103}	1
a_8	1	a_{40}	-1	a_{72}	1	a_{104}	1
a_9	1	a_{41}	-1	a_{73}	1	a_{105}	1
a_{10}	-1	a_{42}	1	a_{74}	-1	a_{106}	-1
a_{11}	-1	a_{43}	1	a_{75}	-1	a_{107}	-1
a_{12}	1	a_{44}	-1	a_{76}	1	a_{108}	1
a_{13}	-1	a_{45}	1	a_{77}	-1	a_{109}	-1
a_{14}	-1	a_{46}	1	a_{78}	-1	a_{110}	-1
a_{15}	1	a_{47}	-1	a_{79}	1	a_{111}	1
a_{16}	1	a_{48}	1	a_{80}	1	a_{112}	-1
a_{17}	-1	a_{49}	-1	a_{81}	-1	a_{113}	1
a_{18}	-1	a_{50}	-1	a_{82}	-1	a_{114}	1
a_{19}	1	a_{51}	1	a_{83}	1	a_{115}	-1
a_{20}	1	a_{52}	1	a_{84}	1	a_{116}	-1
a_{21}	1	a_{53}	1	a_{85}	1	a_{117}	-1
a_{22}	-1	a_{54}	-1	a_{86}	-1	a_{118}	1
a_{23}	-1	a_{55}	-1	a_{87}	-1	a_{119}	1
a_{24}	1	a_{56}	-1	a_{88}	1	a_{120}	1
a_{25}	-1	a_{57}	1	a_{89}	-1	a_{121}	-1
a_{26}	1	a_{58}	-1	a_{90}	1	a_{122}	1
a_{27}	-1	a_{59}	1	a_{91}	-1	a_{123}	-1
a_{28}	1	a_{60}	-1	a_{92}	1	a_{124}	1
a_{29}	1	a_{61}	-1	a_{93}	1	a_{125}	1
a_{30}	1	a_{62}	-1	a_{94}	1	a_{126}	1
a_{31}	1	a_{63}	-1	a_{95}	1	a_{127}	1

b

$b_0 b_1 b_2 b_3 b_4 b_5 b_6 b_7 \dots b_{124} b_{125} b_{126} b_{127}$

Element of Golay code <i>b</i>	Value	Element of Golay code <i>b</i>	Value	Element of Golay code <i>b</i>	Value	Element of Golay code <i>b</i>	Value
b_0	1	b_{32}	1	b_{64}	1	b_{96}	-1
b_1	1	b_{33}	1	b_{65}	1	b_{97}	-1
b_2	1	b_{34}	1	b_{66}	1	b_{98}	-1
b_3	1	b_{35}	1	b_{67}	1	b_{99}	-1
b_4	-1	b_{36}	-1	b_{68}	-1	b_{100}	1
b_5	1	b_{37}	1	b_{69}	1	b_{101}	-1
b_6	-1	b_{38}	-1	b_{70}	-1	b_{102}	1
b_7	1	b_{39}	1	b_{71}	1	b_{103}	-1
b_8	1	b_{40}	-1	b_{72}	1	b_{104}	1
b_9	1	b_{41}	-1	b_{73}	1	b_{105}	1
b_{10}	-1	b_{42}	1	b_{74}	-1	b_{106}	-1
b_{11}	-1	b_{43}	1	b_{75}	-1	b_{107}	-1
b_{12}	-1	b_{44}	1	b_{76}	-1	b_{108}	-1
b_{13}	1	b_{45}	-1	b_{77}	1	b_{109}	1
b_{14}	1	b_{46}	-1	b_{78}	1	b_{110}	1
b_{15}	-1	b_{47}	1	b_{79}	-1	b_{111}	-1
b_{16}	1	b_{48}	1	b_{80}	1	b_{112}	-1
b_{17}	-1	b_{49}	-1	b_{81}	-1	b_{113}	1
b_{18}	-1	b_{50}	-1	b_{82}	-1	b_{114}	1
b_{19}	1	b_{51}	1	b_{83}	1	b_{115}	-1
b_{20}	-1	b_{52}	-1	b_{84}	-1	b_{116}	1
b_{21}	-1	b_{53}	-1	b_{85}	-1	b_{117}	1
b_{22}	1	b_{54}	1	b_{86}	1	b_{118}	-1
b_{23}	1	b_{55}	1	b_{87}	1	b_{119}	-1
b_{24}	1	b_{56}	-1	b_{88}	1	b_{120}	1
b_{25}	-1	b_{57}	1	b_{89}	-1	b_{121}	-1
b_{26}	1	b_{58}	-1	b_{90}	1	b_{122}	1
b_{27}	-1	b_{59}	1	b_{91}	-1	b_{123}	-1
b_{28}	-1	b_{60}	1	b_{92}	-1	b_{124}	-1
b_{29}	-1	b_{61}	1	b_{93}	-1	b_{125}	-1
b_{30}	-1	b_{62}	1	b_{94}	-1	b_{126}	-1
b_{31}	-1	b_{63}	1	b_{95}	-1	b_{127}	-1

Simplified System Block diagram

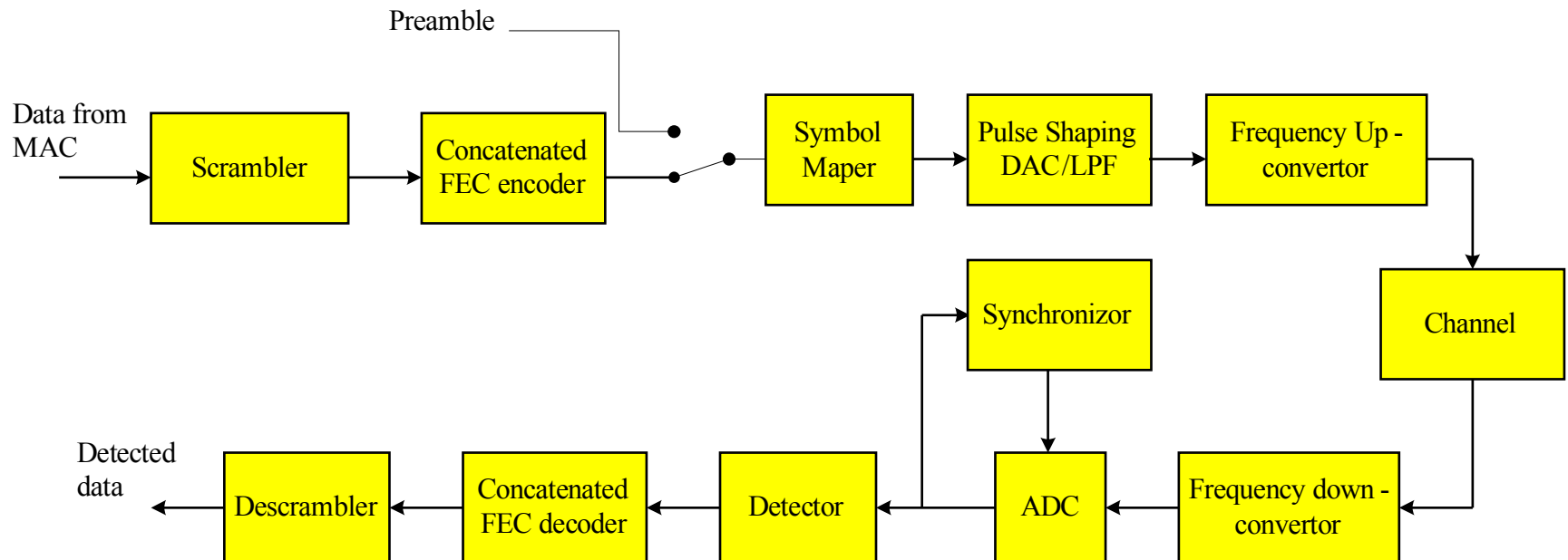

Gray-coded Constellation Mapping

- OOK:
 - Input bit = 1: I-phase = 1, Q-phase = 0
 - Input bit = 0: I-phase = 0, Q-phase = 0
- BPSK:
 - Input bit = 1: I-phase = 1, Q-phase = 0
 - Input bit = 0: I-phase = -1, Q-phase = 0
- QPSK:
 - Input bits = 11: I-phase = A, Q-phase = A
 - Input bits = 10: I-phase = A, Q-phase = -A
 - Input bits = 01: I-phase = -A, Q-phase = A
 - Input bits = 00: I-phase = -A, Q-phase = -A
 where $A = \sqrt{2}/2$

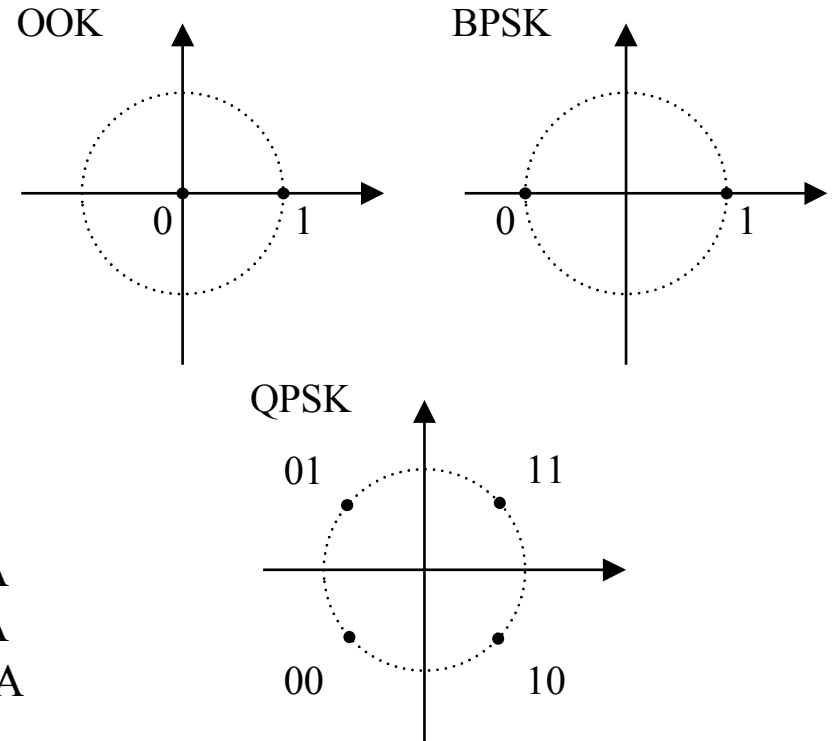

Pulse Shaping

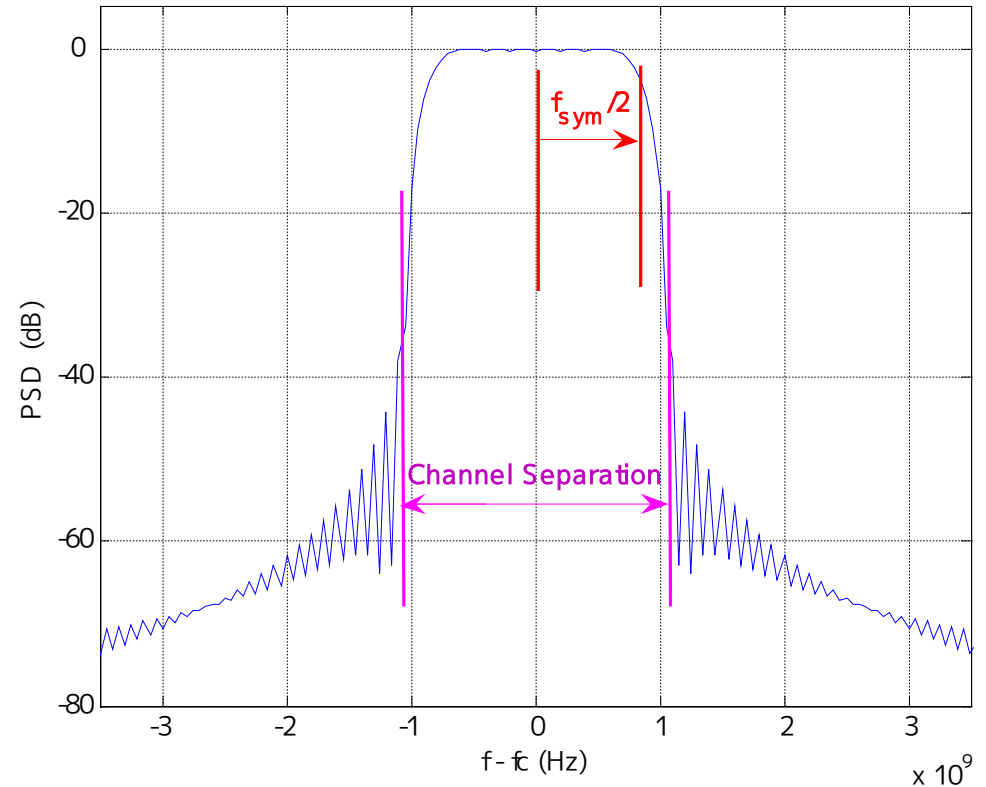
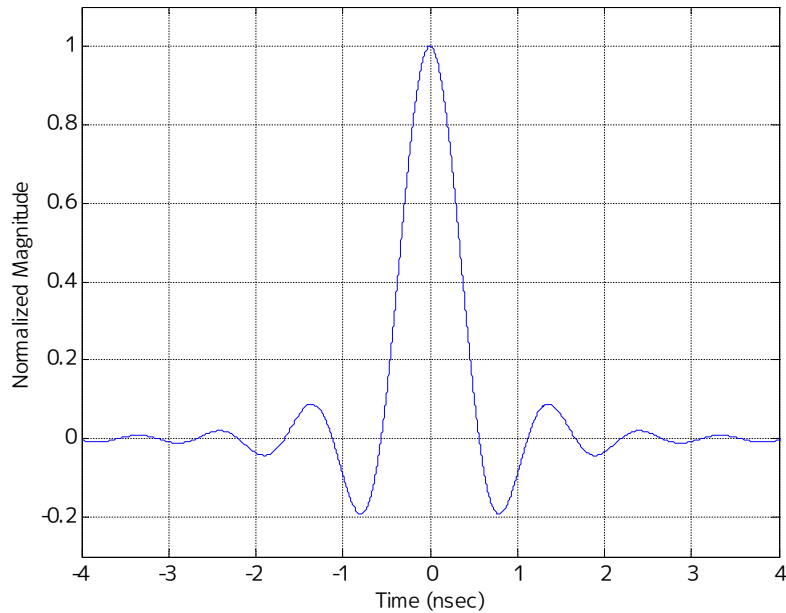

- Root raised cosine function with roll-off factor 0.25

Simulation and Performance Evaluation

- AWGN, CM9.1, CM9.2, CM1.3 and CM3.1 channels are tested.
- Assume LOS link between Tx and Rx directional antennas of 30 deg with perfect manually aiming
- Assume perfect synchronization
- Transmission range is typically at 1 meter
- Payload length = 2K bytes
- No Equalization, no FDE
- Mean 90% PER and BER link success probabilities versus E_b/N_0 is examined at performance evaluation.
- BER @ $1e-06$ and PER @ 8% are adopted as criteria for required E_b/N_0

Performance in AWGN

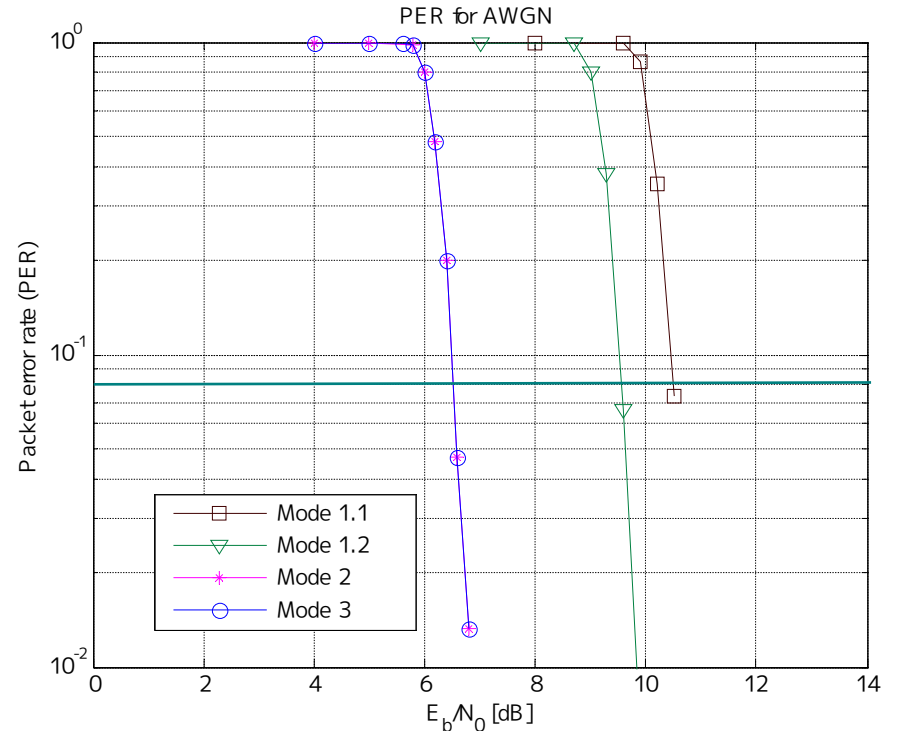
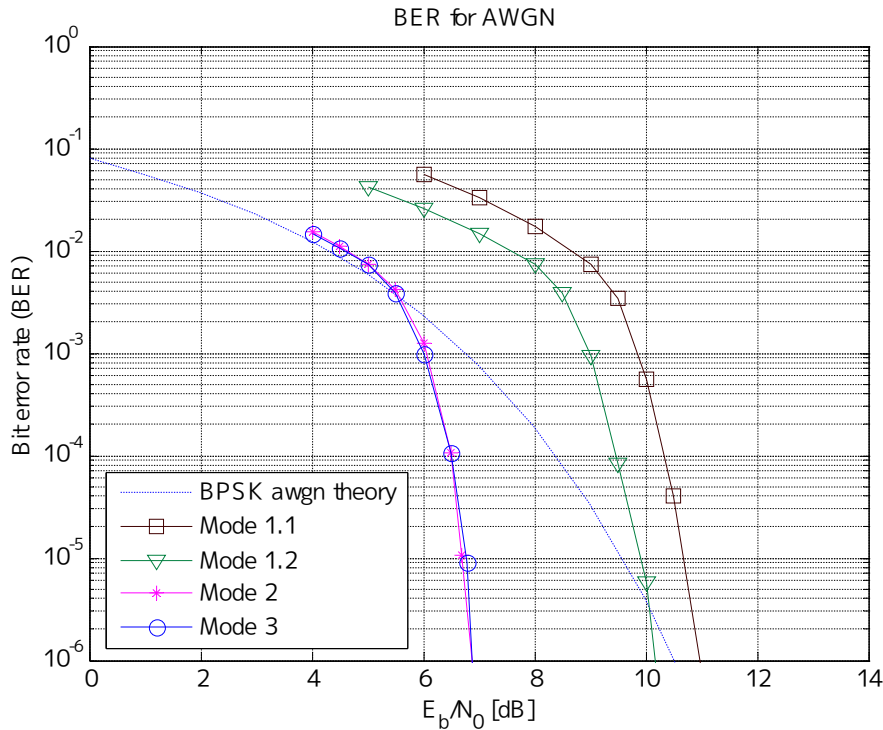

	Required E_b/N_0 at BER @ $1e-6$ (dB)	Required E_b/N_0 at PER @ 8% (dB)
Mode 1.1	11.1	10.5
Mode 1.2	10.2	9.5
Mode 2	6.9	6.5
Mode 3	6.9	6.5

Performance in CM9.1

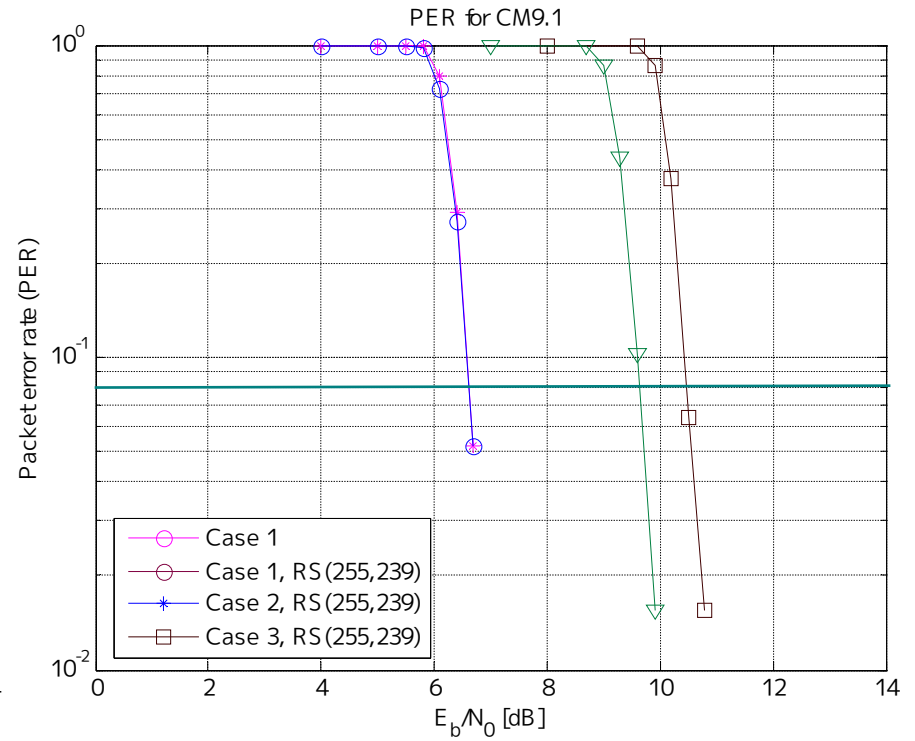
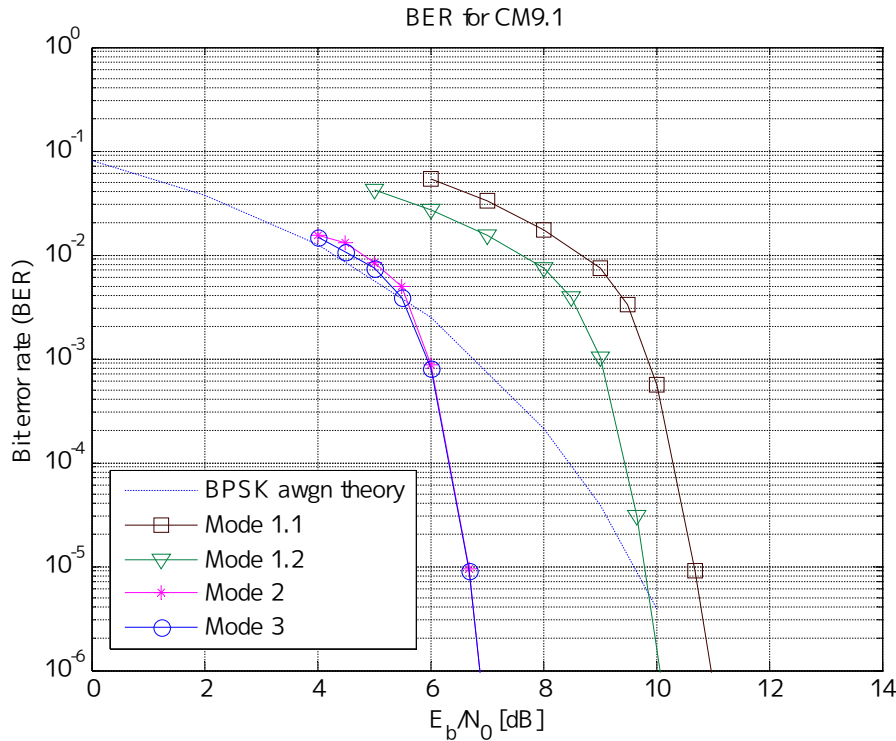

	Required E_b/N_0 at BER @ $1e-6$ (dB)	Required E_b/N_0 at PER @ 8% (dB)
Mode 1.1	11.1	10.6
Mode 1.2	10.2	9.7
Mode 2	6.9	6.7
Mode 3	6.9	6.7

Performance in CM9.2

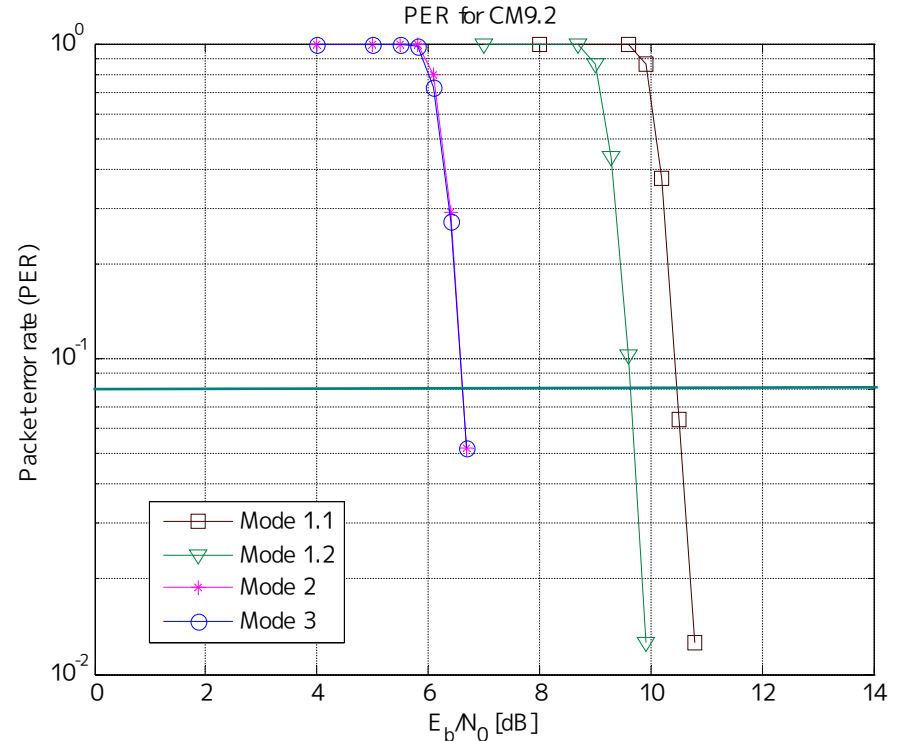
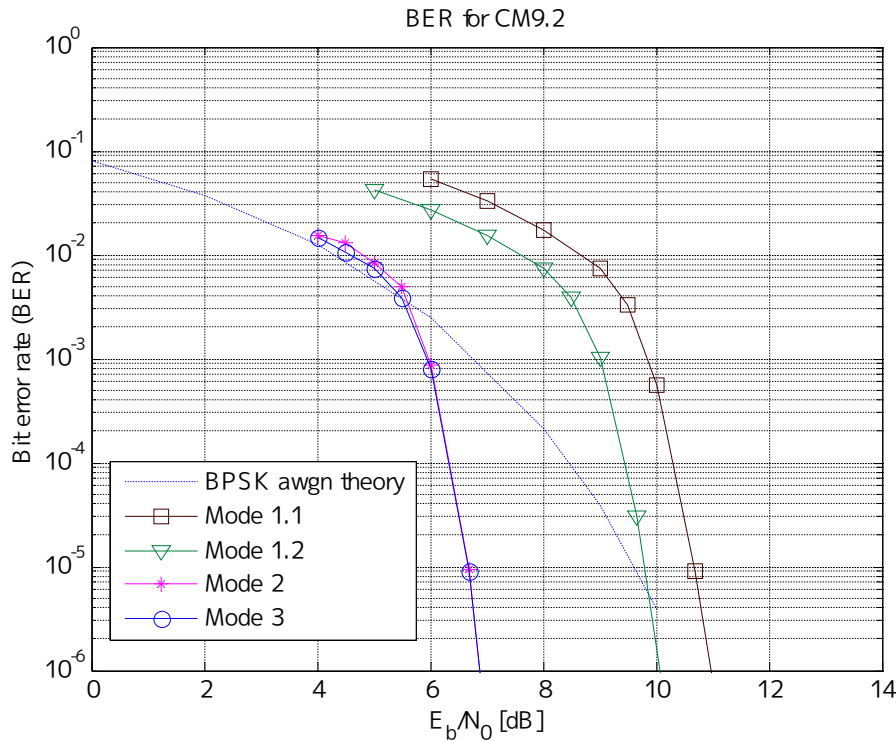

	Required E_b/N_0 at BER @ $1e-6$ (dB)	Required E_b/N_0 at PER @ 8% (dB)
Mode 1.1	11.1	10.5
Mode 1.2	10.2	9.6
Mode 2	6.9	6.6
Mode 3	6.9	6.6

Performance in CM1.3

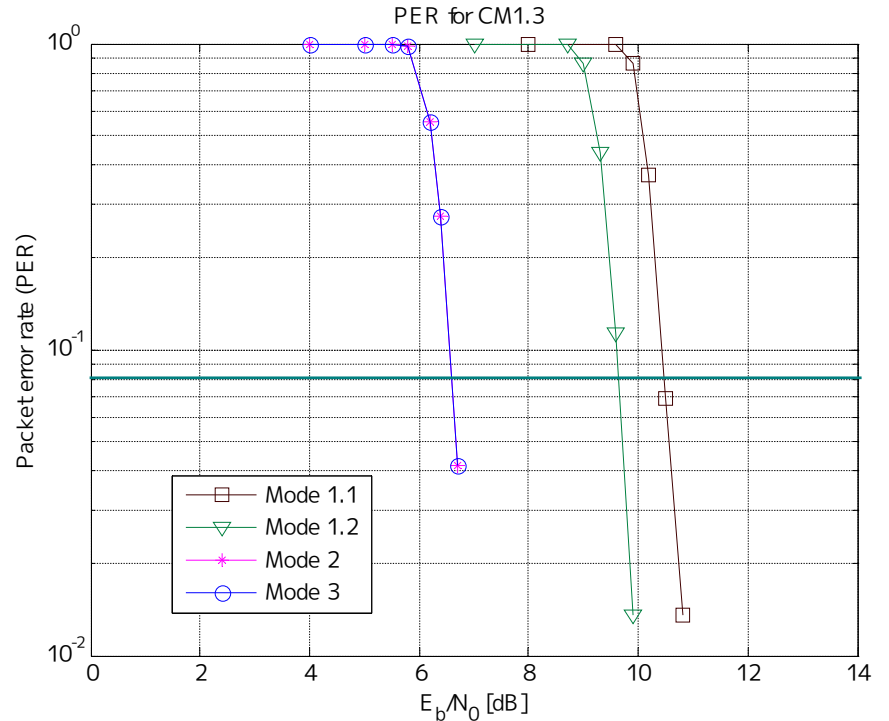
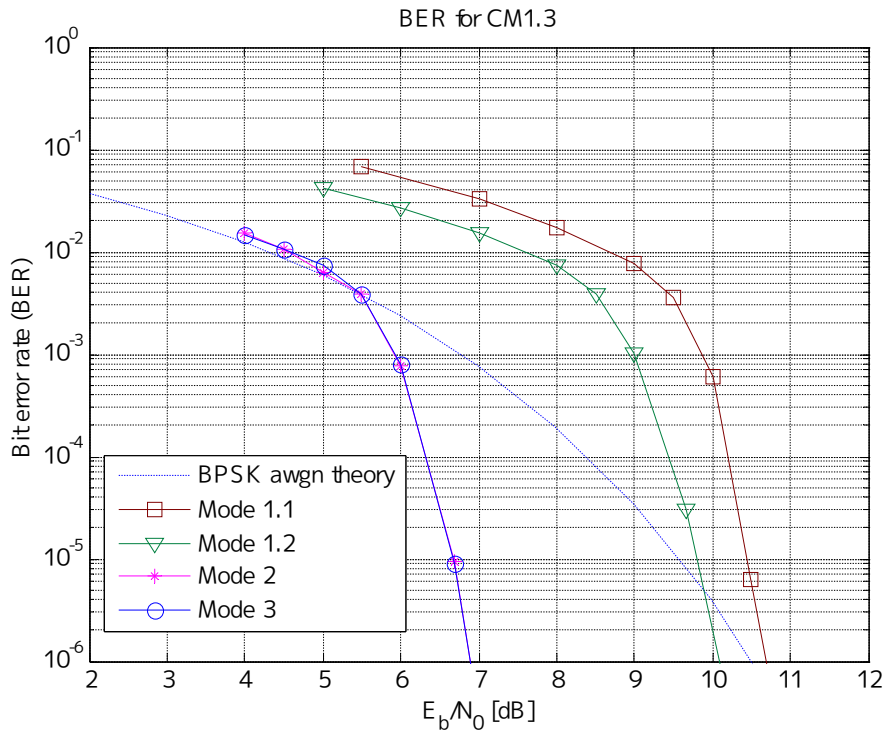

	Required E_b/N_0 at BER @ $1e-6$ (dB)	Required E_b/N_0 at PER @ 8% (dB)
Mode 1.1	11.1	10.6
Mode 1.2	10.2	9.6
Mode 2	6.9	6.7
Mode 3	6.9	6.7

Performance in CM3.1

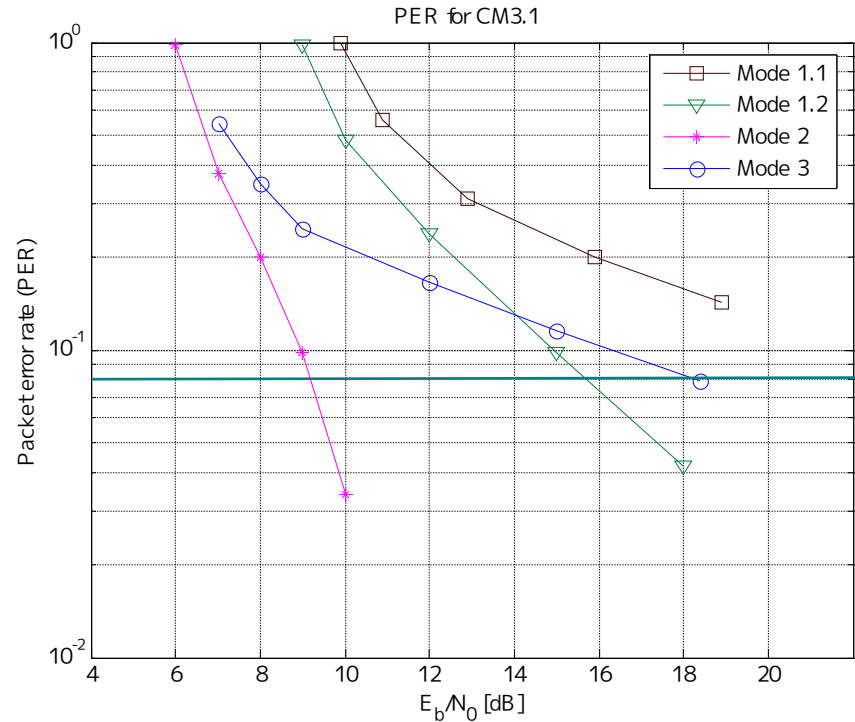
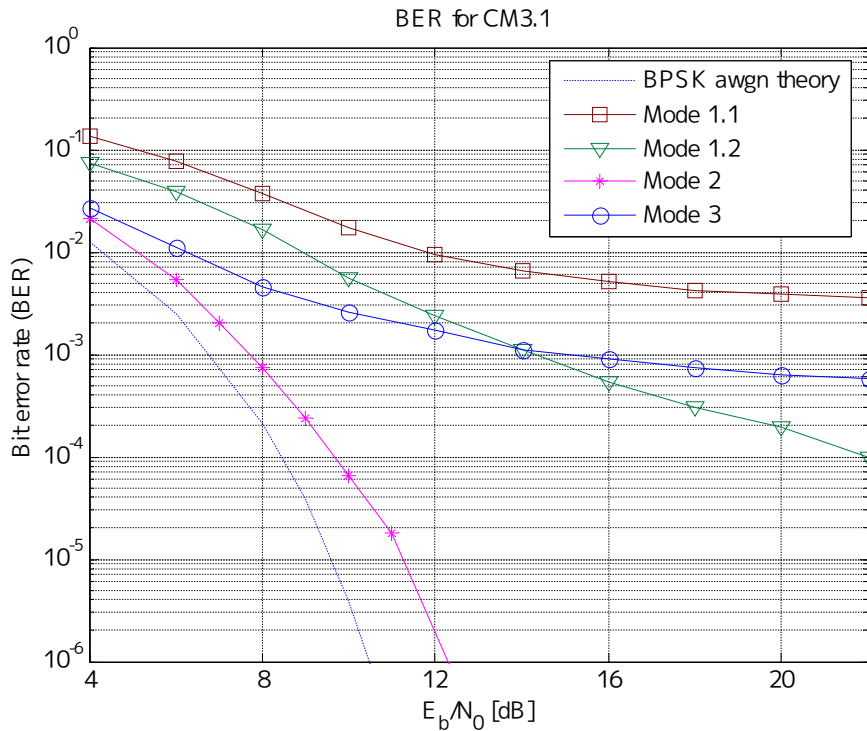

	Required E_b/N_0 at BER = $1e-6$ (dB)	Required E_b/N_0 at PER = 0.08 (dB)
Mode 1.1	-	-
Mode 1.2	-	15.6
Mode 2	12.3	9.1
Mode 3	-	18.4

Required Eb/N0 (dB) Summary Table

Mode	AWGN		CM9.1		CM9.2		CM1.3		CM3.1	
	BER @ 1e-06	PER @ 8%	BER @ 1e-06	PER @ 8%	BER @ 1e-06	PER @ 8%	BER @ 1e-06	PER @ 8%	BER @ 1e-06	PER @ 8%
1.1	11.1	10.5	11.1	10.6	11.1	10.5	11.1	10.6	-	-
1.2	10.2	9.5	10.2	9.7	10.2	9.6	10.2	9.6	-	15.6
2	6.9	6.5	6.9	6.7	6.9	6.6	6.9	6.7	12.3	9.1
3	6.9	6.5	6.9	6.7	6.9	6.6	6.9	6.7	-	18.4

AWGN (or nearly AWGN) channel is usually valid for portable devices with directional antenna (Tx: 30°, Rx: 30°) and short range LOS link (within 1 meter) at Kiosk and Residential environments.

AWGN (or nearly AWGN) channel is also valid at office LOS environments, but sometimes heavy multipath may occur.

Implementation Feasibility

Block Diagram – OOK Radio Architecture (*non-coherent detection*)

- OOK non-coherent enables **Simplest Radio Architecture**
- Transmitter : Up Converter

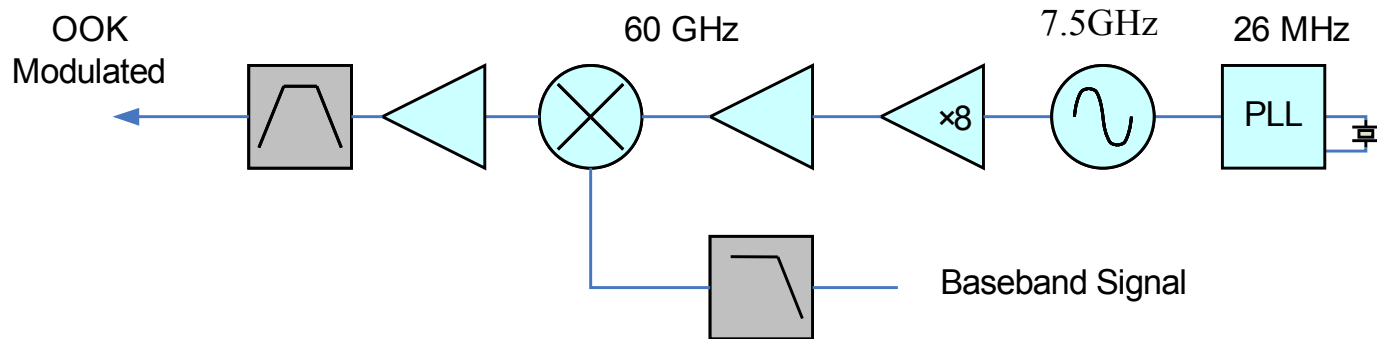

- Receiver : Envelop Detection

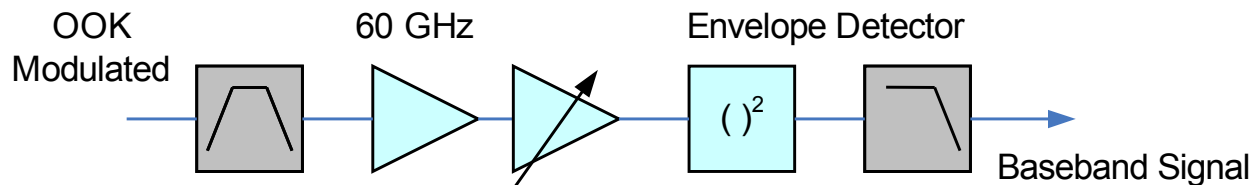

Block Diagram – OOK/PSK Architecture (*coherent detection*)

- Transmitter/Receiver : Quadrature Modulator/Demodulator

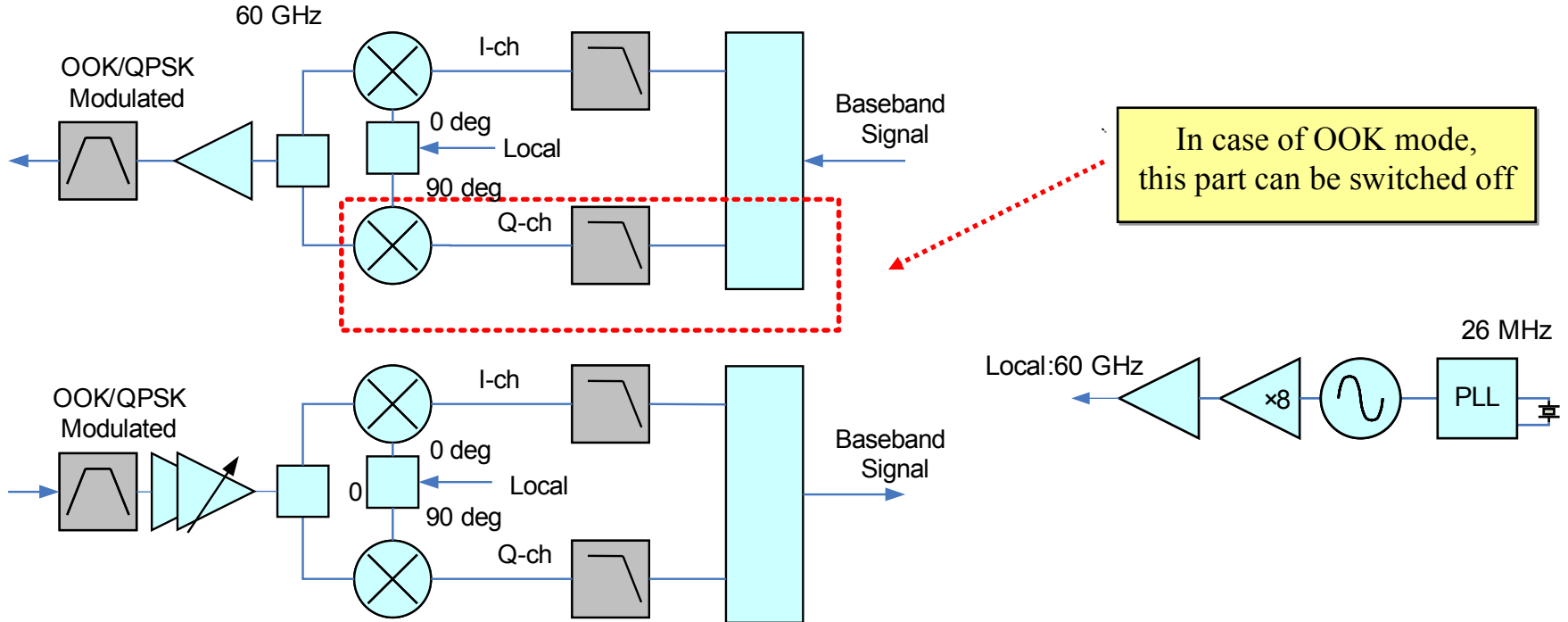

Hardware modification between various signal formats

		Signal Format		
		OOK	PSK	OFDM
transmitter	SC-OOK	OK	-	-
	SC-PSK	easy* ¹	OK	-
	OFDM	easy* ¹	possible* ²	OK
receiver	SC-OOK	OK	-	-
	SC-PSK	easy* ¹	OK	-
	OFDM	easy* ¹	possible* ²	OK

*1: It is easy for SC-PSK/OFDM transmitter/receiver to transmit/demodulate OOK signals.

*2: It is possible for OFDM transmitter/receiver to transmit/demodulate PSK signals.

Hardware modification (example)

- No additional analog circuit is necessary to detect OOK signal for BPSK/QPSK receiver

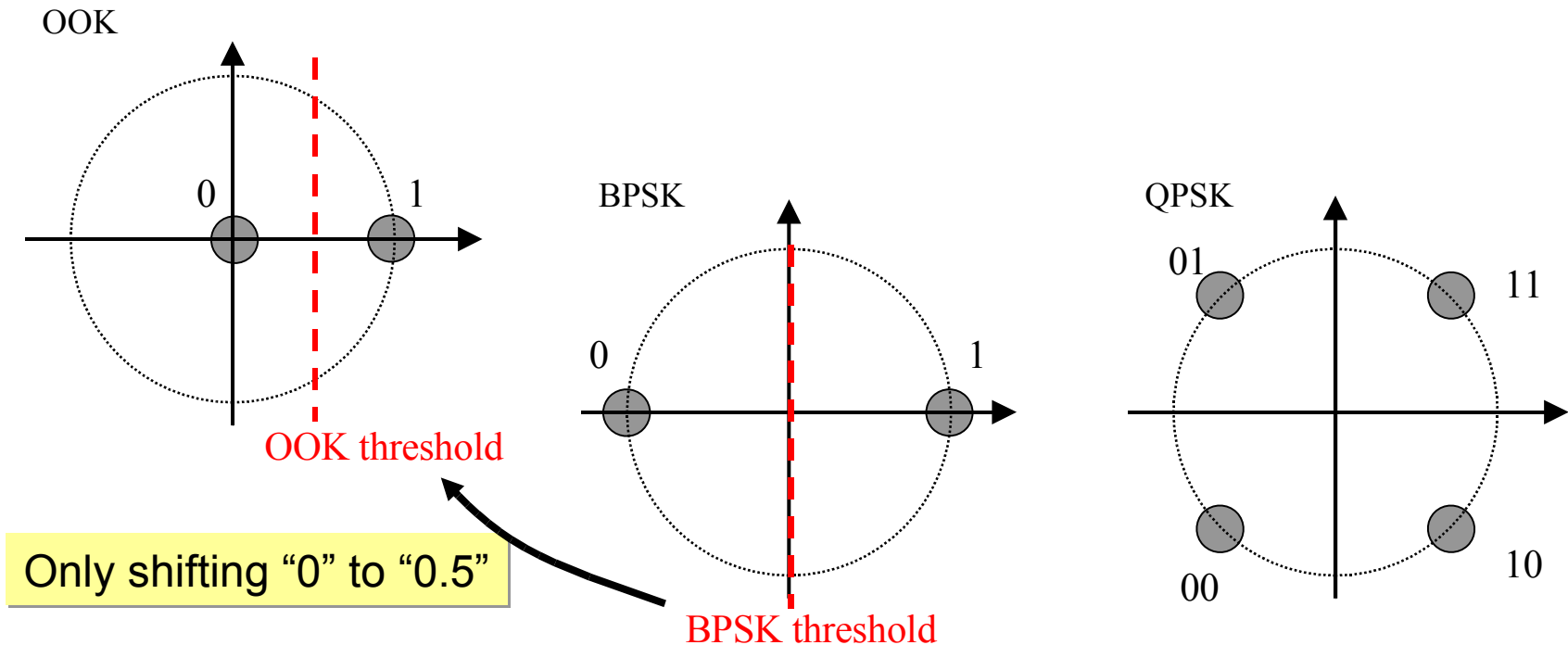

Manufacturability

- UM5 device can be integrated in 90nm-CMOS-SoC
 - RF
 - 0 dBm output power is enough for short range of UM5
 - 90 nm CMOS is easy to generate 1mW output power
 - No requirement of low phase noise
 - Baseband
 - Envelope detector can be employed in case of non-coherent
 - No requirement of high bit-resolution ADC

Power Consumption Estimations in RF (*non-coherent*)

Block	Circuit	Power Consumption (mW)	Notes
TX	PA	20	0 dBm output
	MIX	10	
	VCO	20	7.5 GHz OSC + X 8 multiplier
	PLL	50	
	Sub total	100	During RX, PA and MIX can be turned off
RX	LNA	10	10 dB
	VGA	20	20 dB (max)
	Detector	5	Diode detector with bias
	Baseband Amp.	5	Broadband amp.
	Sub total	40	During TX, all circuits can be turned off

Assumption by 90nm-CMOS, some results are calculated by using 0.15um GaAs based P-HEMT
 Ref: B.Heydari et.al., "Low-Power mm-wave Components up to 104 GHz in 90nm CMOS", ISSCC2007

Link Budget Margin (AWGN/Nearly AWGN)

	Low Power Mode				Unit
Modulation scheme	OOK	OOK	BPSK	QPSK	
Detection	Noncoherent	Coherent			
Reference Range	1				m
Symbol Rate	1.664				GS/s
FEC	RS(255,239)				
PHY-SAP Payload Bit Rate (R_b)	1.5596		3.1192		Gb/s
Average Tx power (P_T)	0				dBm
Tx Antenna Gain (G_T)	10				dB
EIRP	10				dBm
Center Frequency (f_c)	60				GHz
Path loss in free space at reference range (PL_0)	68				dB
Rx Antenna Gain (G_R)	10				dB
Average noise power per bit ($N = -174 + 10 * \log_{10}(R_b)$)	-82.07		-79.06		dBm
Rx Noise Figure referred to the antenna terminal (N_F)	10				dB
Average noise power per bit ($P_N = N + N_F$)	-72.07		-69.06		dBm
Implementation Loss (I)	5				dB
Shadowing link margin ($M_{shadowing}$)	1				dB
Required Eb/No @ BER=1e-06 (S) *	11.1	10.2	6.9	6.9	dB
Tolerable path loss ($PL = P_T + G_T + G_R - P_N - S - M_{shadowing} - I - PL_0$)	6.97	7.87	11.17	8.16	dB
Maximum operating range ($d = 10^{PL/10n}$)	2.23	2.48	3.62	2.56	m

*) The required Eb/No @ BER=1e-06 is larger than the one @ PER = 8%

ARQ (bit inverted retransmitting)

- Simple ARQ scheme
 - For retransmission, bit inverting is adopted for OOK at frame payload to avoid ISI due to multi-path effects
 - Bit inverting for OOK:
bit “1” → bit “0”, bit “0” → bit “1”

(i) times : 1,0,0,0,1,1,0,0,11.....

 **Bit inverter**

(i+1) times : 0,1,1,1,0,0,1,1,0,0....

MAC Layer

Supporting OOK and PSK coexistence
based on 802.15.3 MAC

PHY Mode

- **Common mode as mandatory is SC mode**
 - Common mode transmission (CMT) : 48.7 Mbps (1.664 Gbps x 32 spreading)
- **3 types of multi-rate transmission based on PHY-SAP data rate of SC or OFDM mode, and optionally supporting OOK modes in LRT**
 - SC/OFDM low rate transmission (SC/OFDM LRT) : up to 2Gbps

- Common mode-

PHY Mode	Transmission Mode	PHY-SAP data rate	Nyquist BW	Modulation	Coding	Spreading factor
Common mode	Common mode transmission (CMT)	48.7 Mbps	1.664 GHz	pi/2 DBPSK	RS(255,239)	32

- Optional Polling Signal mode for OOK-

PHY Mode	Transmission Mode	PHY-SAP data rate	Nyquist BW	Modulation	Coding	Spreading factor
Polling mode	Polling transmission (PT)	48.7 Mbps	1.664GHz	OOK	RS(255,239)	32 (2 repetition x 16)

PHY Mode

- SC LRT(up to 2Gbps) -

PHY Mode	Transmission Mode	PHY-SAP data rate	Nyquist BW	Modulation	Coding	Spreading factor		
SC mode	LRT 1	97.5Mbps	0.832GHz	pi/2 DBPSK	RS(255,239)	8		
	LRT 2	195Mbps				4		
	LRT 3	390Mbps				2		
	LRT 4	780Mbps				1		
	LRT 5	1560Mbps				-		
	LRT 6	48.7Mbps	1.664GHz	pi/2 DBPSK	RS(255,239)	32		
	LRT 7	97.5Mbps				16		
	LRT 8	195Mbps				8		
	LRT 9	390Mbps				4		
	LRT 10	780Mbps				2		
	LRT 11	1560Mbps				1		
	LRT 12	832Mbps				pi/2 DBPSK	LDPC(1152,576)	-
	LRT 13	1248Mbps					LDPC(1152,864)	-
	LRT 14	832Mbps				GMSK	LDPC(1152,576)	-
	LRT 15	1248Mbps					LDPC(1152,864)	-
	LRT 16	1560Mbps		RS(255,239)	-			
	LRT 17	1560Mbps		MSK	RS(255,239)	-		
	LRT 18	1664Mbps		QPSK	LDPC(1152, 576)	-		
	LRT 19	390Mbps		OOK	RS(255,239)	4		
	LRT 20	780Mbps				(4 repetition)		
	LRT 21	1560Mbps				2		
					(2 repetition)			
					1			

Superframe structure (802.15.3)

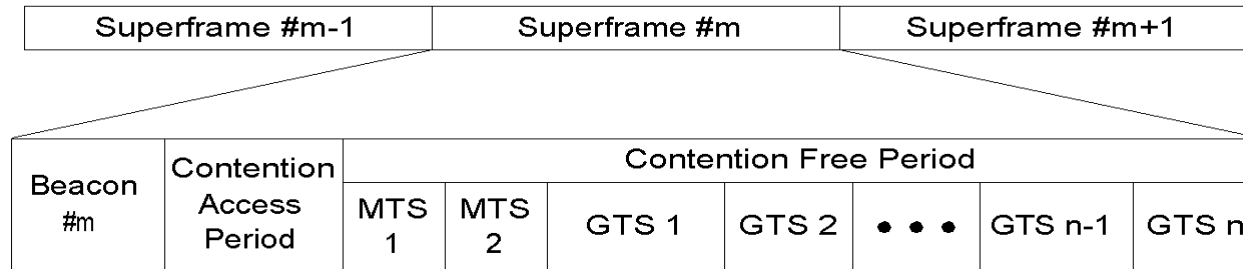

- Arrangement of periods and slots is decided by PNC (PicoNet Controller) and is informed using beacons.
- An unassociated device tries to associate to the piconet after receiving a beacon.
 - An unassociated device sends a association request packet during CAP (Contention Access Period) according to the contention basis.
- An associated device sends packets :-
 - During CAP according to the contention basis if PNC allows to use CAP for data transmission.
 - Or asking PNC to allocate time slots in CFP (Contention Free Period).

Observation on IEEE UMD requirement

- There are two mandatory UMs:
 - UM1: Uncompressed video streaming
 - Point to Point, Long Range, High Power, High Data Rate, Full MAC
 - Examples: Set-top Box to TV, PC to Monitor, etc.
 - UM5: Kiosk file downloading
 - Point to Point, Short Range, Low power, Low Data Rate, Minimum MAC
 - Examples: Phone, PDA, iPod, etc
- Two mandatory UMs leads to different requirements on PHY layer
 - High End PHY (HEP):
 - Advanced Digital Modulation with High Power, e.g. OFDM and SC-FDE, to support rate > 2Gbps over severe multipath channels
 - Low End PHY (LEP):
 - Simple Digital/Analog Modulation with Low Power, e.g. ASK, MSK, FSK, to support rate at 1Gbps over almost AWGN channels
- So all devices must be able to coexist at the same piconet to avoid any interference; therefore, coexistence issue must be solved.

Basic requirements for Coexistence

- IEEE802.15.3 MAC is supported
 - Centralized Piconet with one master device (PNC) to coordinate the channel use by sending beacon periodically
 - When HEP and LEP exist at the same piconet, HEP device can be PNC to save power of LEP device and support a long range beacon.
 - Other devices must listen to PNC beacon before access the medium.
 - Other devices must request medium reservation at CAP using contention based medium access.
 - Time-sharing medium reservation at CFP
- HEP and LEP devices are “independent”, but communication between HEP and LEP devices is supported.
- No unnecessary complexity for LEP devices (simple and low-power)
- The beacon coordination should be efficient and fair. No interference among different communications.

Coexistence among Different PHYs

- Issue #1:
 - Each unassociated device should send packets during CAP.
 - This means contention access mechanism among different PHYs is necessary.

Possible Solutions:

- Split CAP into multiple CAPs for each signal format => Inefficient use of superframe time
 - **Using sensed power as sensed carrier**
- Issue #2:
 - Each device should know the arrangement of each elements in the superframe.
 - This means each device has to understand the beacon.

Possible solutions:

- Understanding the beacon...
 - Single beacon in common signal format
 - **Multiple beacons in each signal format**

Multiple Beaconing using polling signal

- Multiple beacons are preferable.
 - Single common beacon should be sent in the simplest format (e.g. OOK). But that beacon has drawbacks. (transmission range, resistance to multi-path, etc.)
 - Only PNC-enabled devices should have multiple PHYs capability.
 - In 802.15.3 basis, only PNC sends beacons, so overhead of multiple beacons is not large.
 - If PNC has multiple PHYs capability, it is possible to relay packets among different PHY devices.
- Factors for further considerations:
 - Scheduling multiple beacon transmission
 - Coexistence scenario among HEP and LEP systems

Coexistence Scenario with “CoMPA”

Case 1

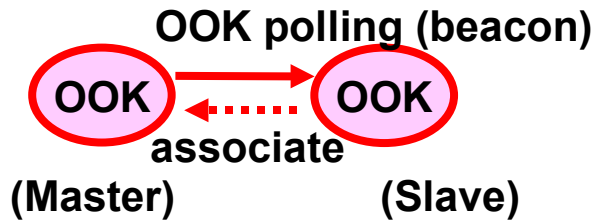

Case 2

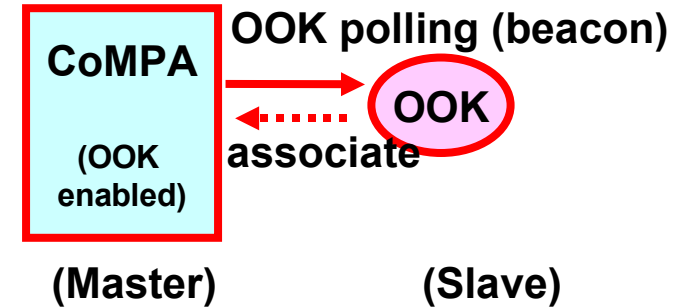

Case 3

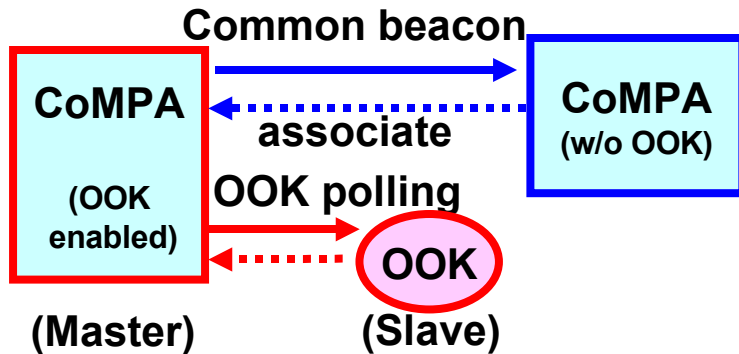

Case 4

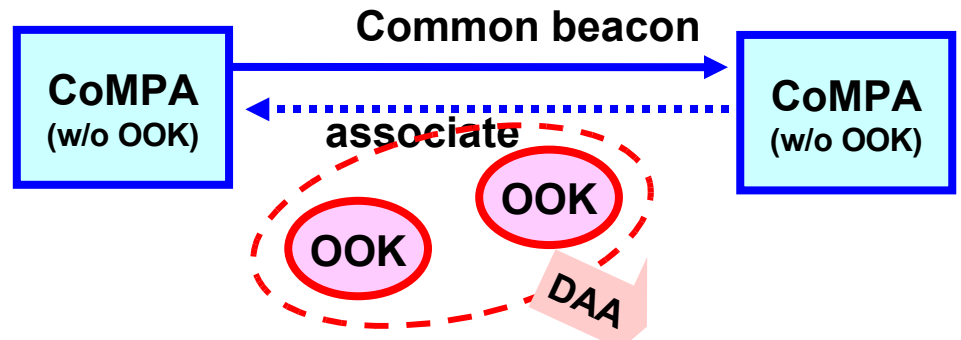

CoMPA device (with OOK) should secure a time slot as a PNC in the CoMPAs' superframe at first and should send a polling to OOK with that time slot information to assure coexistence.

If there is an CoMPAs' piconet and there is no OOK enabled CoMPA device, OOK devices should avoid conflict according to the DAA manner

Multiple beaconing with polling signal in Beacon Period

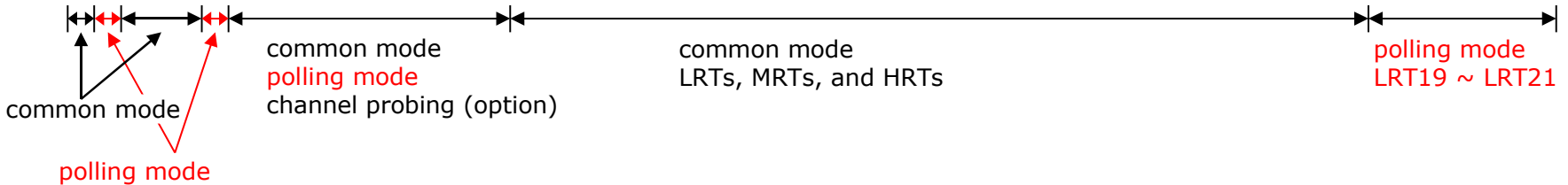
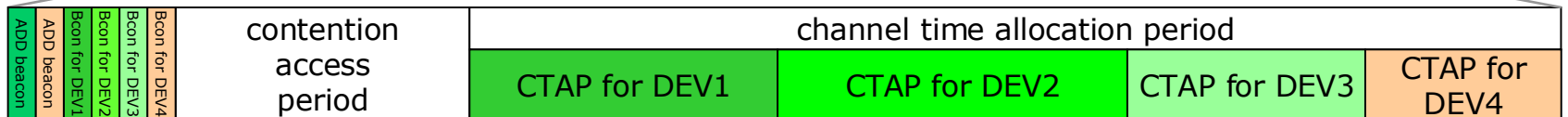
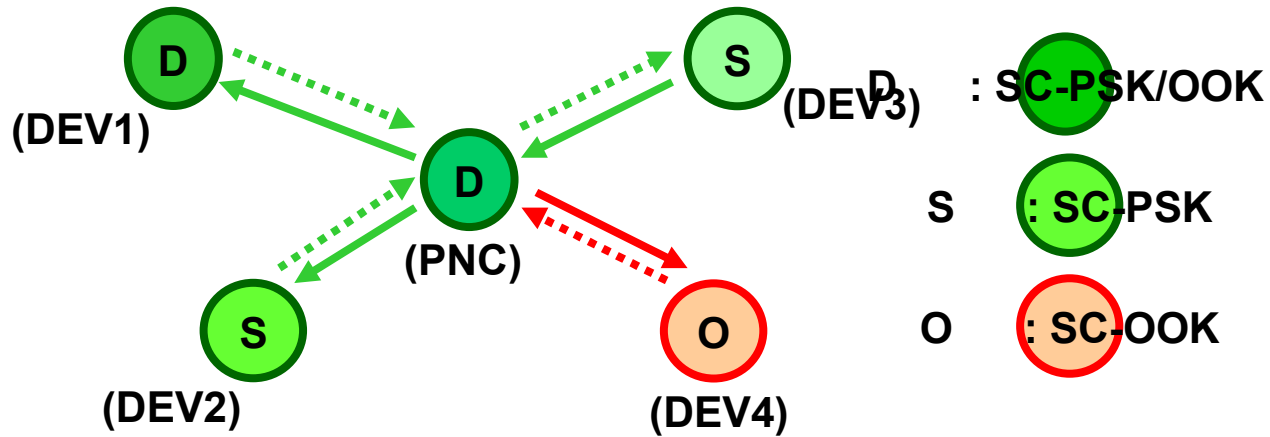

Multiple Beaconsing in BP (detail)

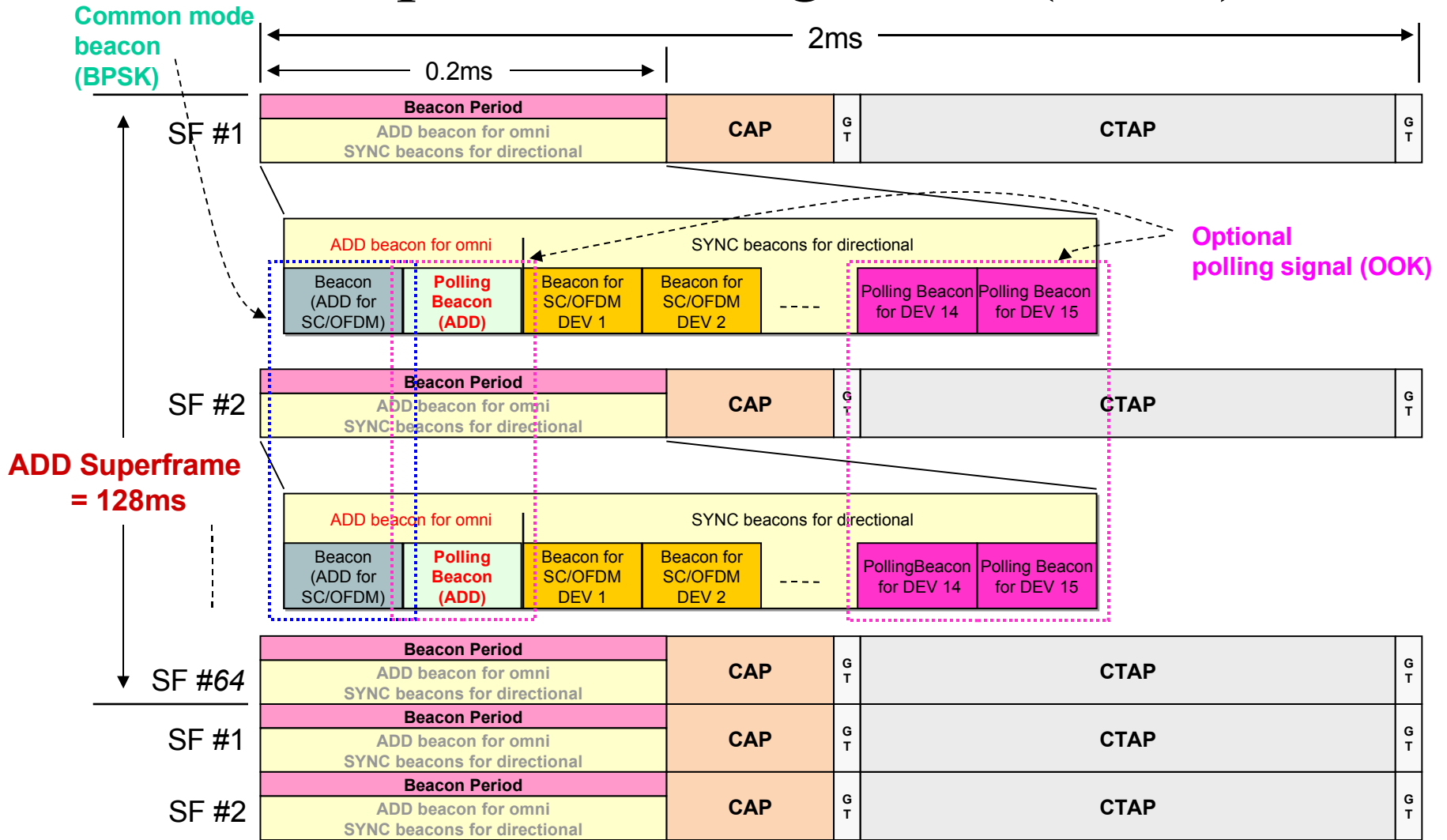

Summary

- OOK modulation is presented in this proposal as an additional mode for BPSK/QPSK transceiver w/o hardware impact
 - Very simple with sufficient rate for portable devices
 - Very low power consumption compared with other modulations
 - Works well on AWGN/KIOSK/Residential LOS channels
 - Very suitable for portable P2P applications
 - Simple coexistence with BPSK/QPSK and other signal devices
- Optional polling signal in Beacon Period provides IEEE 802.15.3 MAC compliant method for HEP and LEP coexistence