

Project: IEEE P802.15 Working Group for Wireless Personal Area Networks (WPANs)

Submission Title: [Research, development and testbed on Smart Utility Networks by IEEE standard]

Date Submitted: [Sep. 18, 2011]

Source: [Fumihide Kojima¹, Hiroshi Harada¹]

Company [¹NICT]

Address [¹3-4, Hikari-no-oka, Yokosuka-shi, Kanagawa 239-0847, Japan]

Voice: [¹+81-46-847-5074]

FAX: [¹+81-46-847-5440]

E-Mail: [{f-kojima,harada} @nict.go.jp]

Re: [In response to TG4g Call for Proposals]

Abstract: [Tutorial presentation on Sep. 19]

Notice: This document has been prepared to assist the IEEE P802.15. It is offered as a basis for discussion and is not binding on the contributing individual(s) or organization(s). The material in this document is subject to change in form and content after further study. The contributor(s) reserve(s) the right to add, amend or withdraw material contained herein.

Release: The contributor acknowledges and accepts that this contribution becomes the property of IEEE and may be made publicly available by P802.15.

Research, development and testbed on Smart Utility Networks by IEEE standard

Fumihide KOJIMA and Hiroshi HARADA

Wireless Network Research Institute, Smart Wireless Laboratory

NICT

E-mail: {f-kojima,harada}@nict.go.jp

IEEE 802 Wireless Interim Meeting

19 September 2011

Okinawa, JAPAN

Summary

- This presentation summarizes NICT's R & D activities on Smart Utility Networks as in the following topics:
 - ▶ Outline of Smart Utility Networks
 - ▷ Use image consisting of SUN-part and WAN-part
 - ▷ SUN requirements
 - Long-lived capability
 - Service area expansion
 - Further requirements
 - ▶ SUN-part activities
 - ▷ Japanese trend on IEEE 802.15.4g standardization
 - Non FH PHY with MPM
 - New allocation in 920 MHz band
 - Low energy support
 - ▷ NICT's activities to realize SUN
 - Proposal on long-lived multi-hop network
 - IEEE 802 15.4g terminal development and proof test
 - ▶ WAN-part activities
 - ▷ NICT's activities to realize WAN
 - Cognitive radio router for advanced WAN
 - Wide area testbed by employing large number of routers
 - Operation in disaster situation
 - ▶ Conclusions

Outline of Smart Utility Networks

Use image of SUN

- Electricity/Gas/Water meters equipping SUN radio devices can effectively automatically relay data frames to the collection station by expanding its service area
- SUN structure includes SUN-part for local data exchange and WAN-part for data collection and control

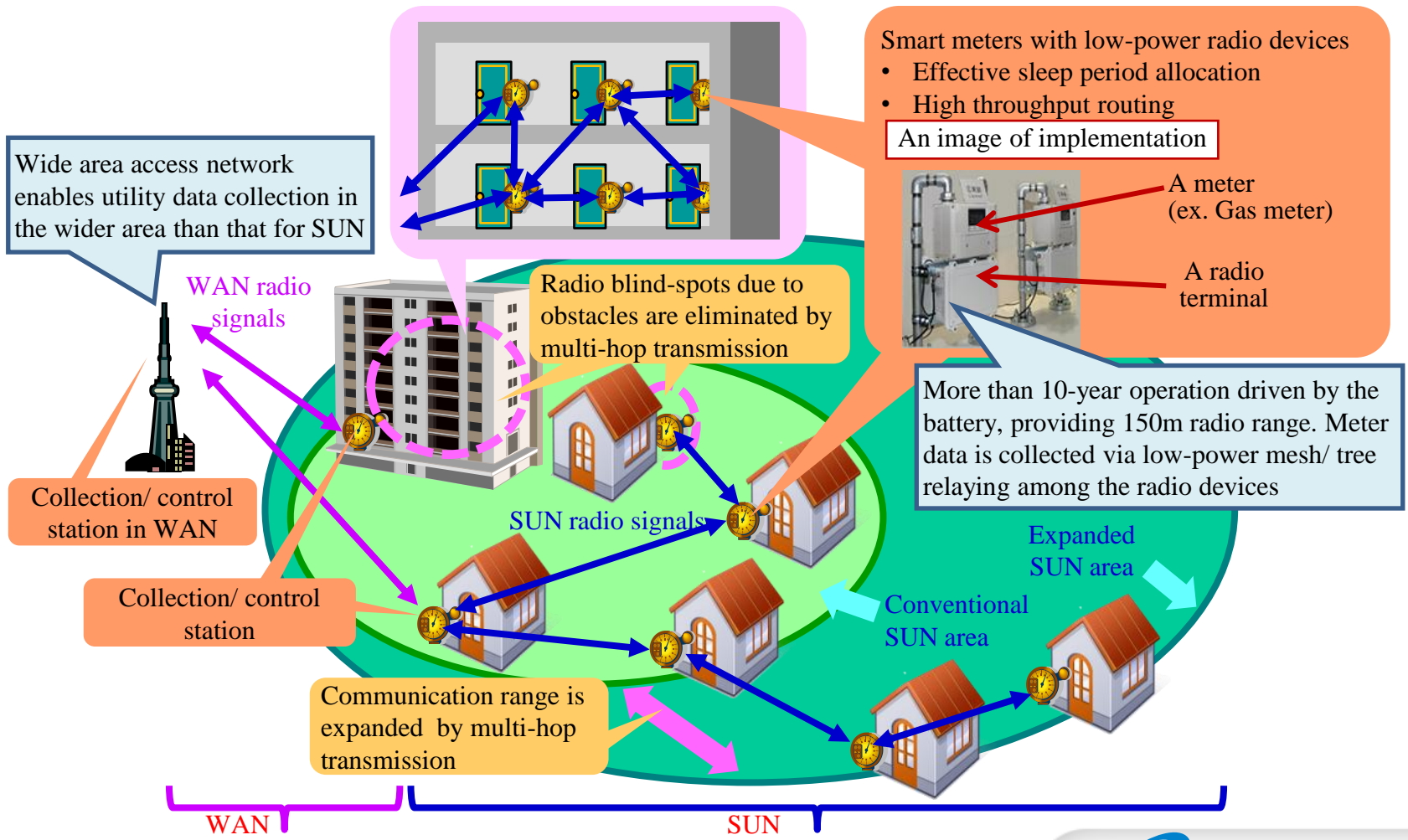

SUN requirements

- SUN requirements are considered as following:
 - ▶ Basic requirements
 - ▷ Long-lived performance
 - More than 10 years operation driven by battery
 - ▷ Service area expansion
 - Multi-hop transmission
 - ▶ Further requirements
 - ▷ Potential control by the internet/cloud
 - To realize effective energy consumption according to the situations
 - To realize terminal mobility support and easy installation
 - ▷ Flexible system-resource allocation
 - To increase system capacity against rapidly increasing demands
 - Enhancement by Cognitive radio and TV white space
 - ▷ Emergency support
 - Capability of long-lived and robust radio infrastructure considering the power supply restricted situations

SUN-part activities

Japanese trend in IEEE 802.15.4g (1): Current PHY spec.

- Non-FH PHY owing to restricted number of frequency channels

MR-FSK allocation in 950-958 MHz (Japan)				
	Mandatory #1	Mandatory #2	Optional #1	Optional #2
Data rate (kbps)	50	100	200	400
Modulation	Filtered 2FSK	Filtered 2FSK	Filtered 2FSK	Filtered 4FSK
Modulation index	1.0	1.0	1.0	0.33
Channel Spacing	200 kHz	400 kHz	600 kHz	600 kHz

- Two octet FCS employment to support short data frame
- SFD indication of FEC

Japanese trend in IEEE 802.15.4g (2): MPM

- In order to realize coexistence among several PHY, Multi-Physical layer Management (MPM) that employs Common Signaling Mode (CSM) is employed

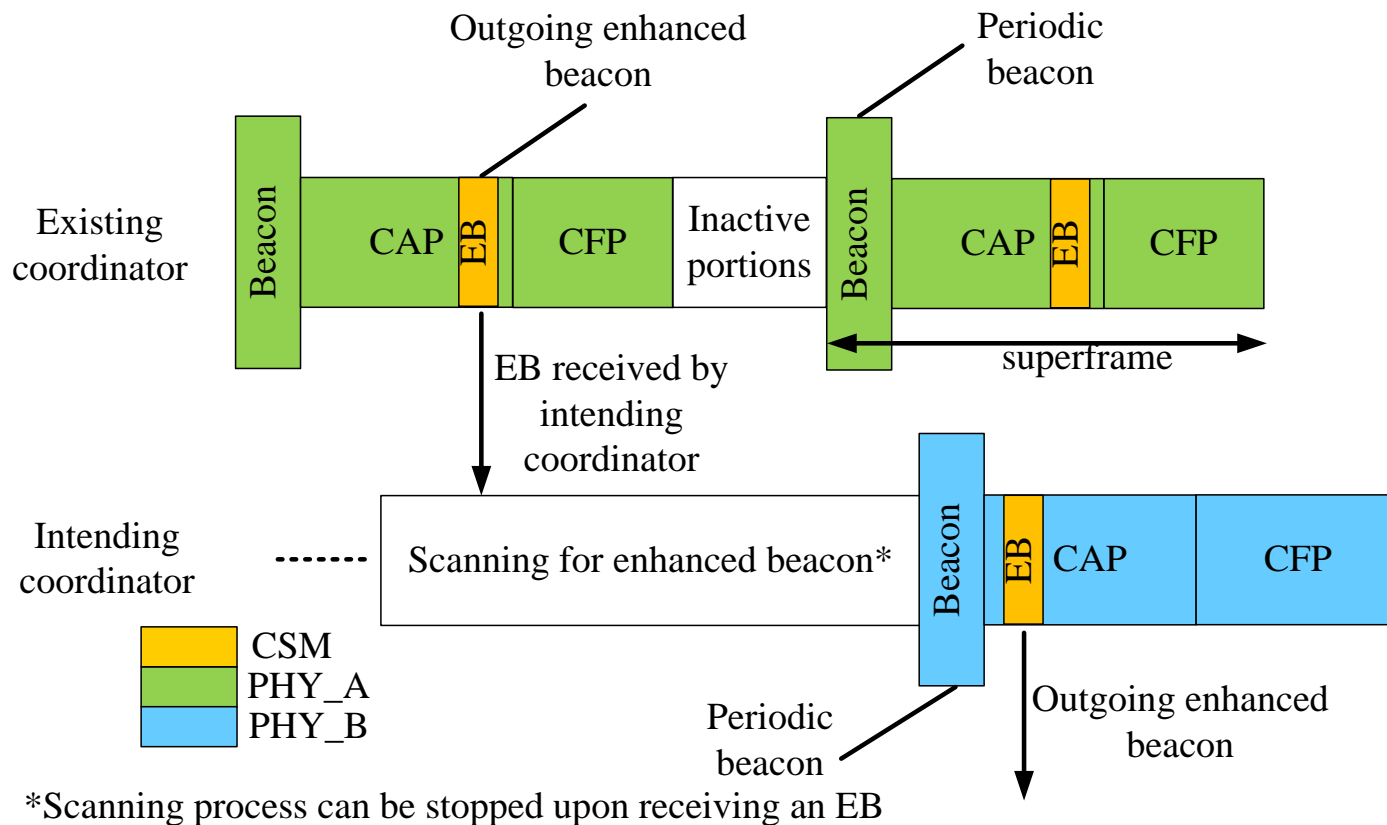

Japanese trend in IEEE 802.15.4g (3): Future channel plan #1

- Frequency band for sensor networks including SUN, smart meters, etc. will be moved from 950MHz band to 920MHz band (915MHz - 930MHz)

* Details are summarized in doc.: IEEE 802.15-04-0510-004g

Current band allocation

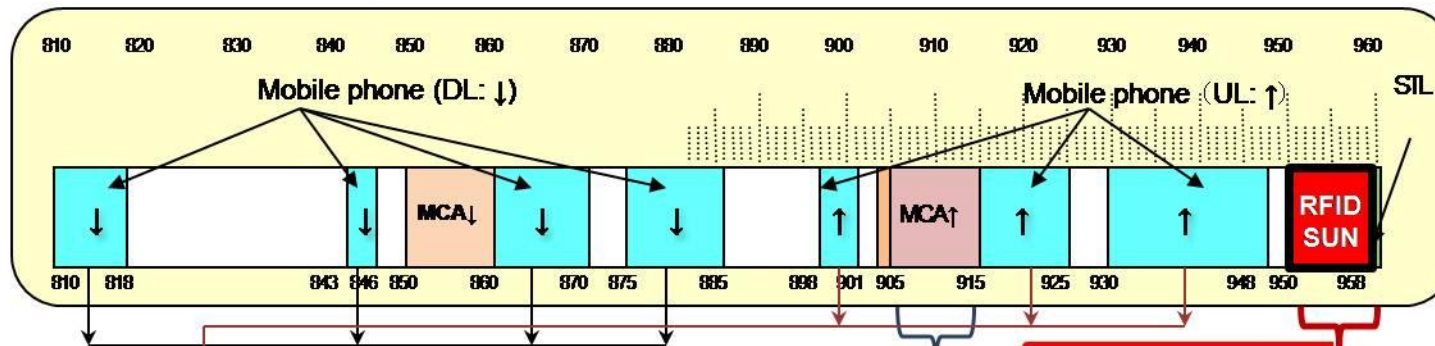

After reallocation

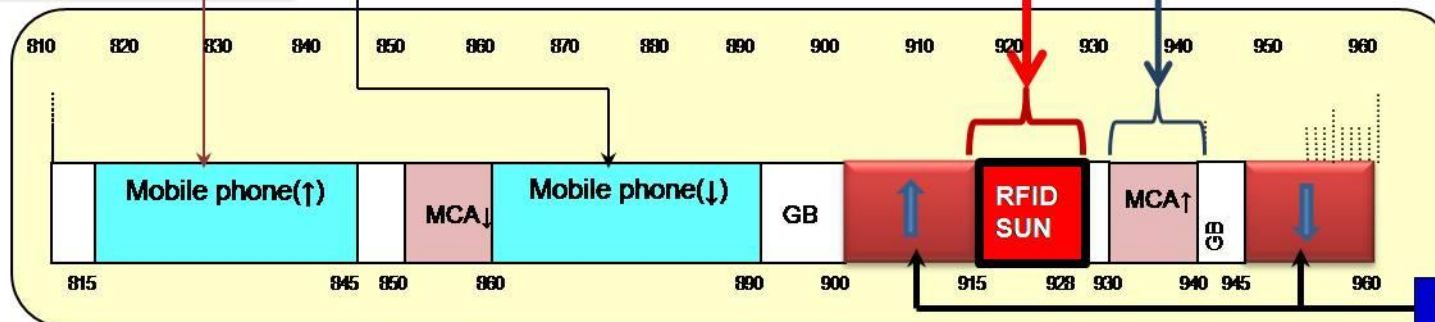

Japanese trend in IEEE 802.15.4g (4): Future channel plan #2

	950 MHz band	920 MHz band
Frequency band	950MHz – 958MHz	915MHz – 930MHz
Output power	10mW / 1mW	250mW / 20mW / 1mW
Other change	Spectrum mask and sending control are also revised according to the new regulations	

Japanese trend in IEEE 802.15.4g (5): Low energy support #1

- In order to realize long-lived performance, MAC oriented low energy technologies are to be employed
 - ▶ By modification of superframe structure
 - ▷ LE Superframe
 - ▶ By newly define MAC protocols
 - ▷ CSL (Coordinated Sampled Listening)
 - ▷ RIT (Receiver Initiated Transmission)

Japanese trend in IEEE 802.15.4g (6): Low energy support #2

- LE superframe
 - ▶ Low energy performance in non-beacon-enabled PAN exploiting:
 - ▷ Turned-off beacons
 - ▷ Inactive periods

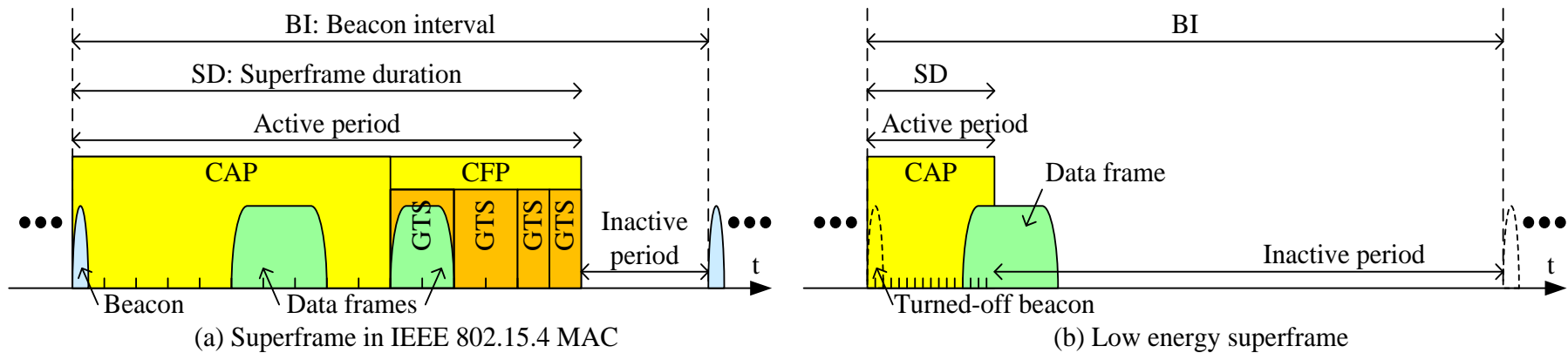

Japanese trend in IEEE 802.15.4g (7): Low energy support #3

● CSL

- ▶ Periodical short listening
- ▶ Short and back-to-back short wake up frames before transmitted frames
- ▶ Wake up frame indicates the following data frame timing

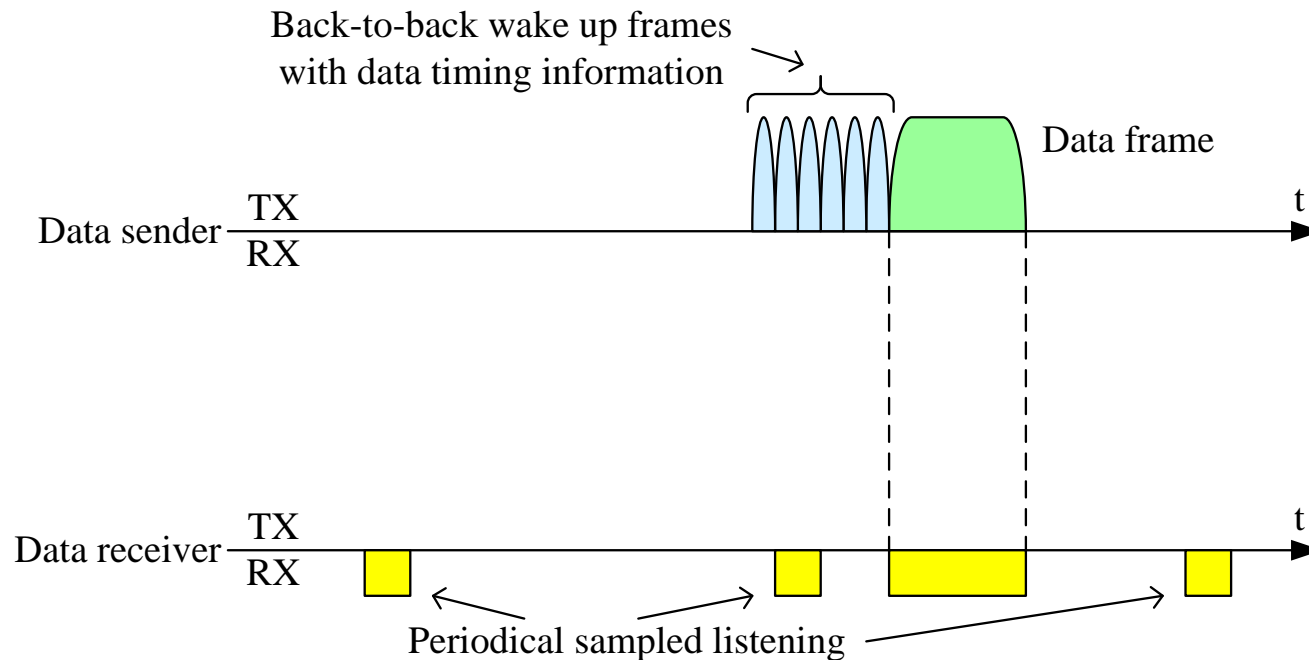

Japanese trend in IEEE 802.15.4g (8): Low energy support #4

● RIT

- ▶ Periodical broadcasting of RIT data request command for synchronization
- ▶ Data frame transmission is synchronized with that RIT data request

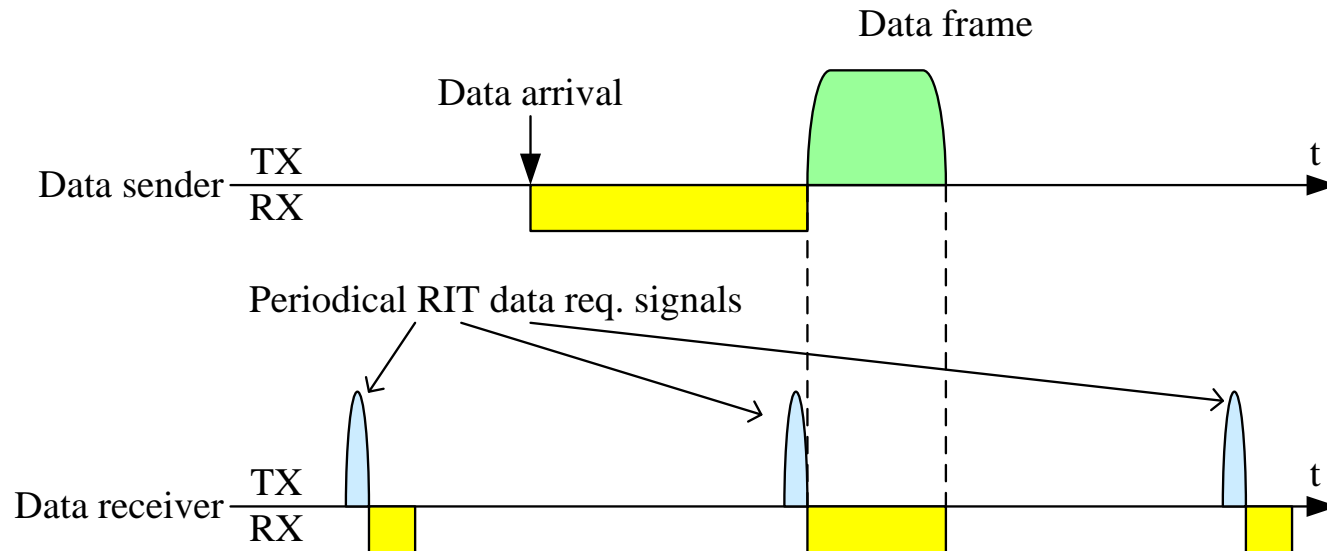

NICT's R&D on SUN(1): Outline

- Basic study on effective frequency utilization for AMI in the MIC technical testing project
 - ▶ 400 MHz and 950 MHz
- Communication scheme with low-power consumption and higher throughput supporting flexible relay & routing by multi-hop transmission
 - ▶ Proposal on IEEE 802.15.4g
- Development of SUN radio terminal thereby conducting proof test

NICT's R&D on SUN(2): Radio propagation evaluation

- With 10 mW transmission power, service area radius of 200 m with more than -60 dBm received power is obtained

Center frequency	953.0MHz
Transmission power	10mW
Antenna gain	2.15dBi
Antenna height	1.2m
Modulation scheme	BPSK
Signal bandwidth	768kHz
Symbol rate	312.5kbps

Experimental area

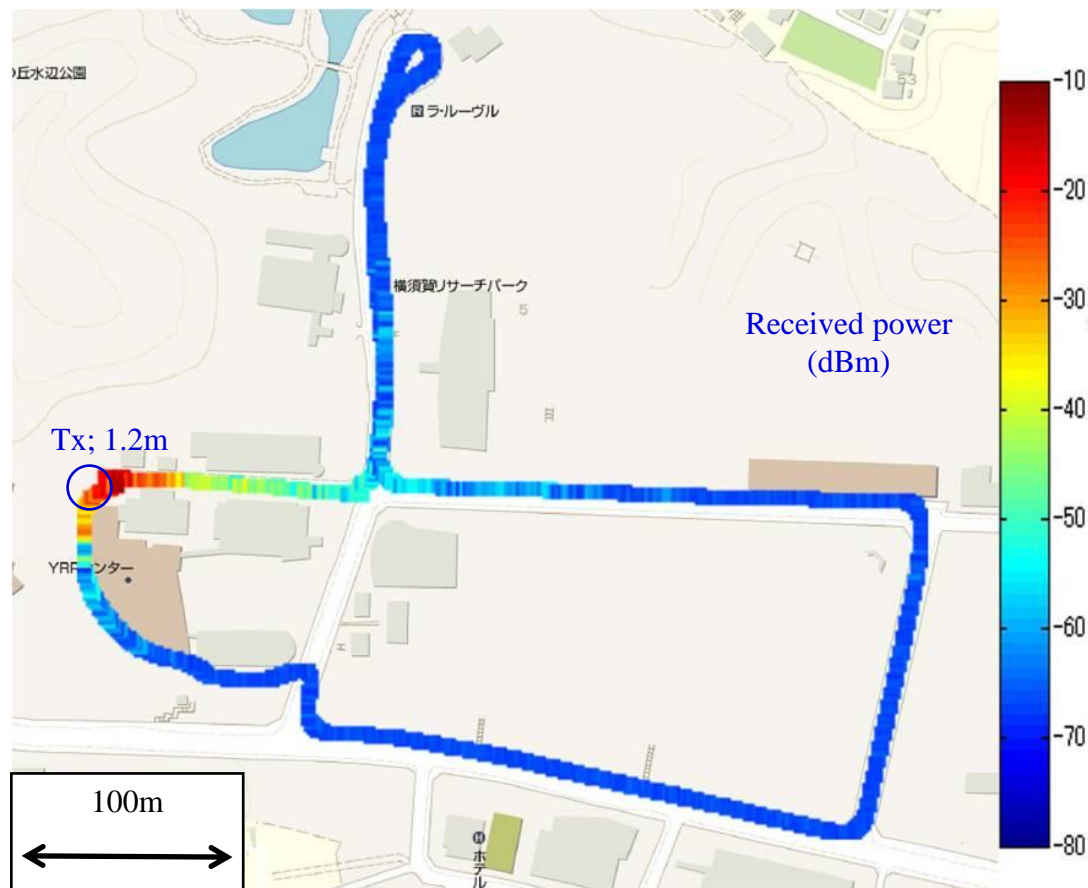

NICT's R&D on SUN(3): Antenna location degradations

The following degradations are confirmed

- ▶ Sheltered: 20dB
- ▶ Fresh water: 40dB~50dB
- ▶ Muddy water: 40dB~50dB
- ▶ Buried in the empty box: 20dB~30dB
- ▶ Buried: 20dB~30dB

劣化量評価 近辺計測

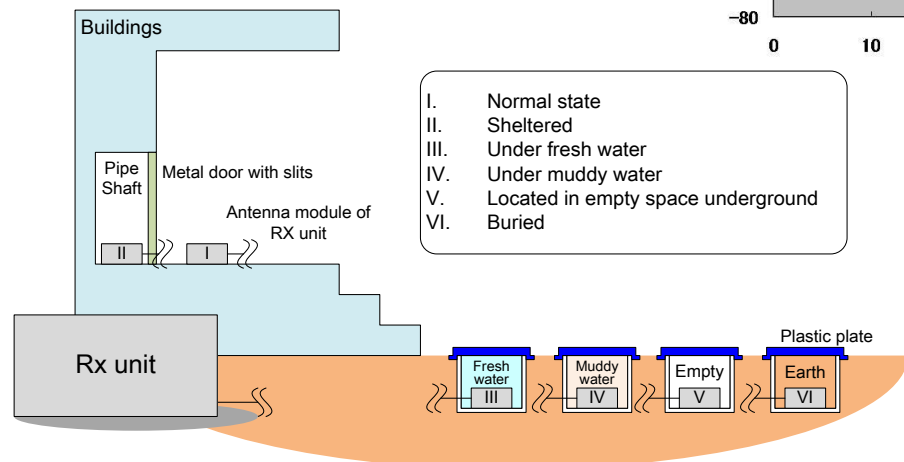
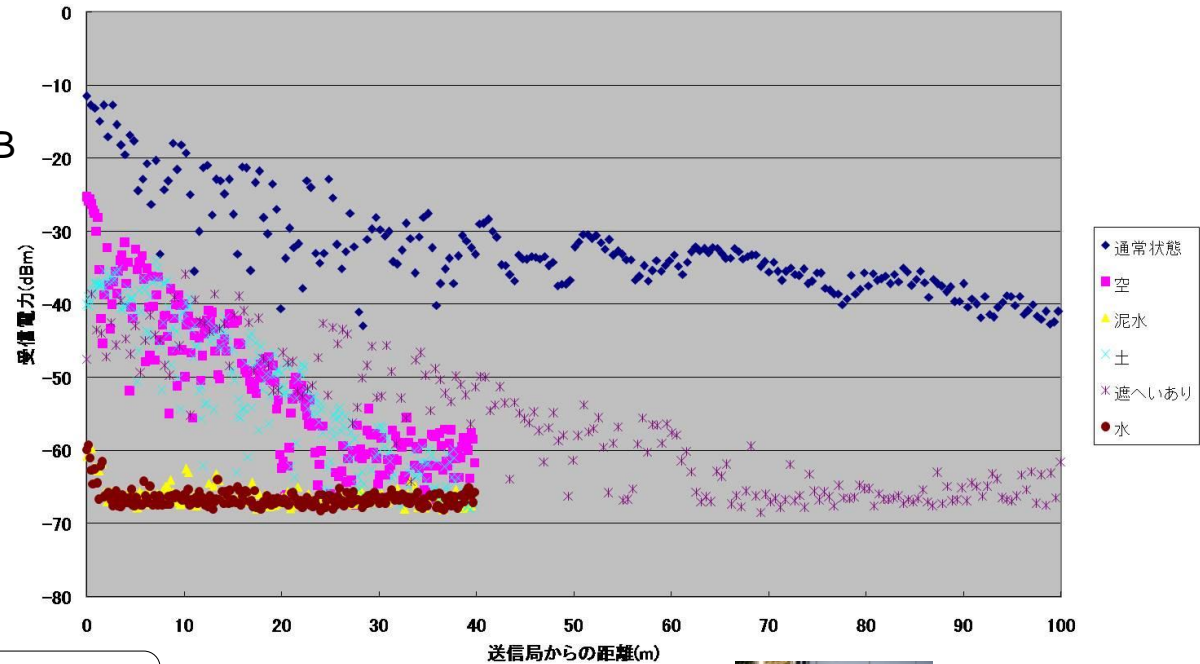

Antenna location in the experiments

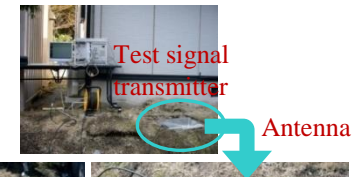

NICT's R&D on SUN(4): Superframes

Data receiving in the inactive period can improve low-power consumption performance

- FFD can define superframe consists of an active period and an inactive period indicated by periodical beacons
- Turned-off beacons with active period
 - ▶ Holding BI based TDMA
 - ▶ Beacon is sent on demand by scan request or synchronization request
- Intermittent hearing only in AP
 - ▶ Active period consists of only CAP
 - ▶ Data frame shall begin in AP and finish before next AP
 - ▶ Only receiver continues receiving till the frame end
 - ▶ Reduced AP where all devices are awake and standing-by

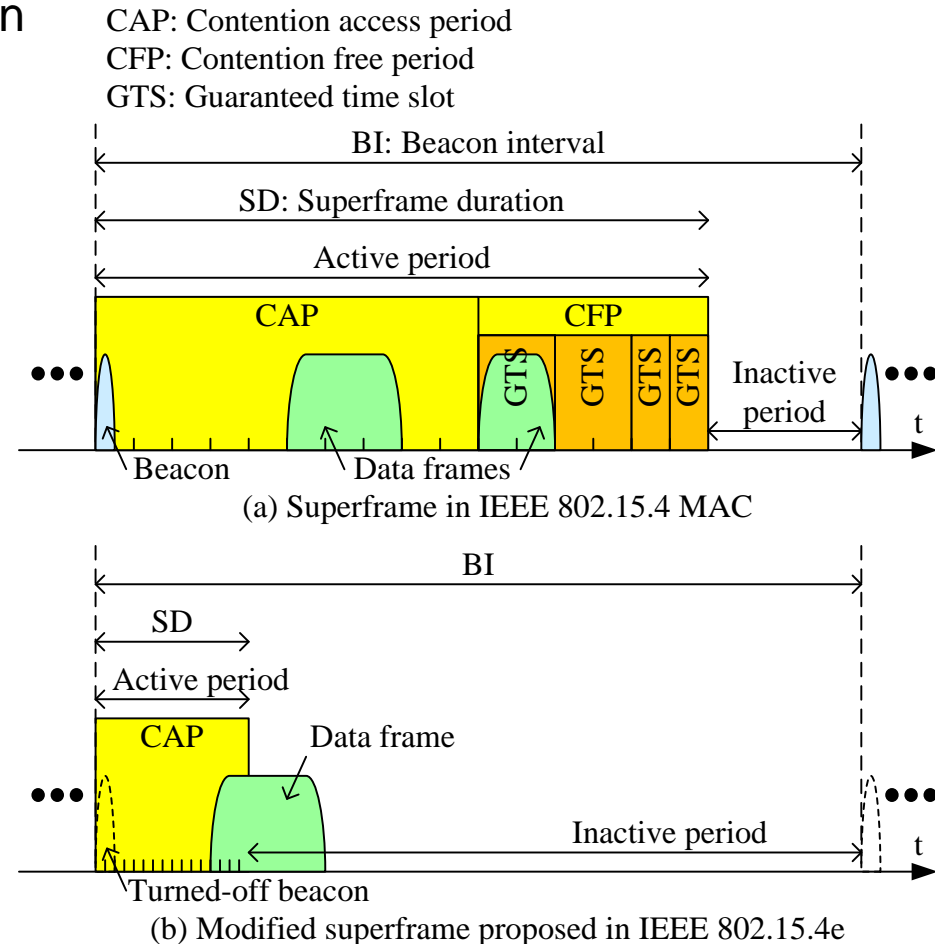

NICT's R&D on SUN(5): Assumed tree topology

- After power-on
 - ▶ The collection station CS makes a PAN by determining PAN ID and superframe duration
 - ▶ Meters M1, M2 and M3 conduct active scan to find the other meter that is a coordinator **connected to the collection meter**, then tries to associate the one
 - ▶ Which coordinator to be selected?
 - ▷ The coordinator with the shortest hop number to the collection meter
 - ▷ The coordinator returns a response-signal with the highest received power among the candidates having the same hop number
- After association
 - ▶ The already associated FFD can return response to the active scan request by defining **outgoing superframe**
 - ▶ Such associated FFD can further accept the association request by unassociated meters

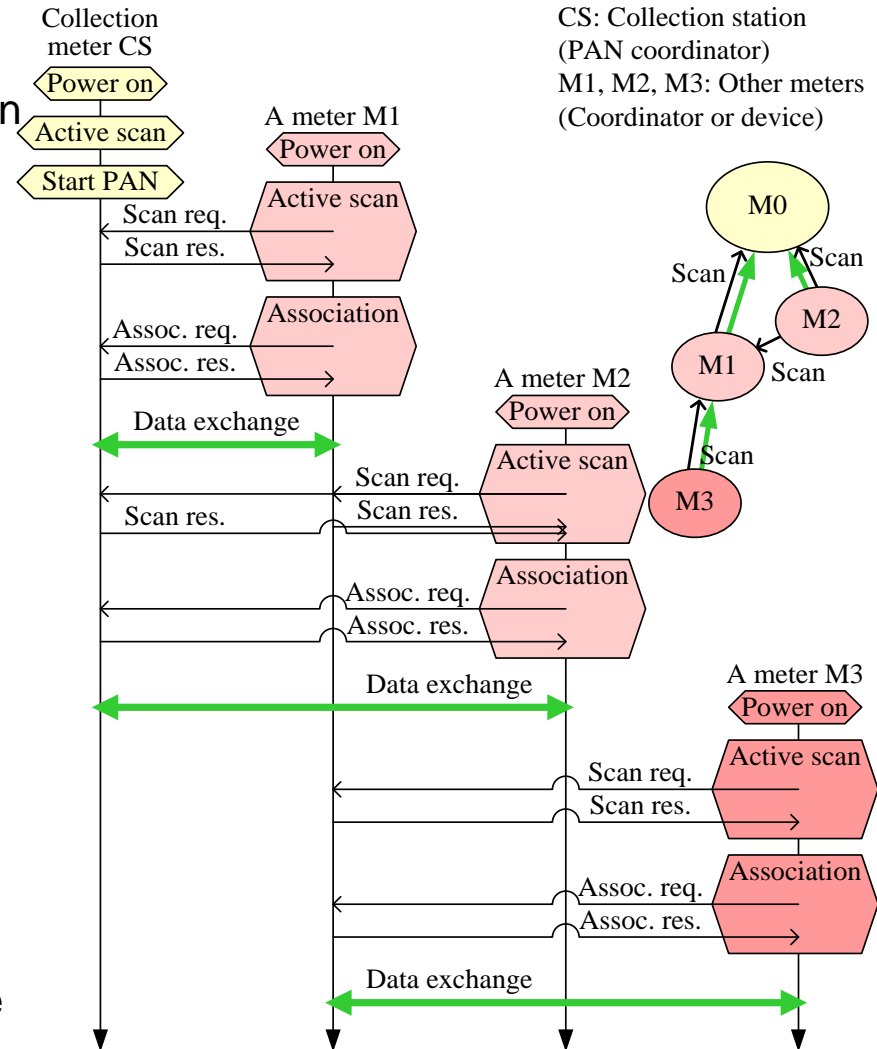

NICT's R&D on SUN(6): Example of frame relaying

- Meters construct tree-shaped topology where each device determines superframe with turned-off beacon
 - In the figure below, a meter M1 is handling both **incoming superframe** by CS and **outgoing superframe** by M1 itself in order to conduct successful data relaying in such tree topology

CS: Collection station (PAN coordinator)

Mn: Meter n (Coordinator or device)

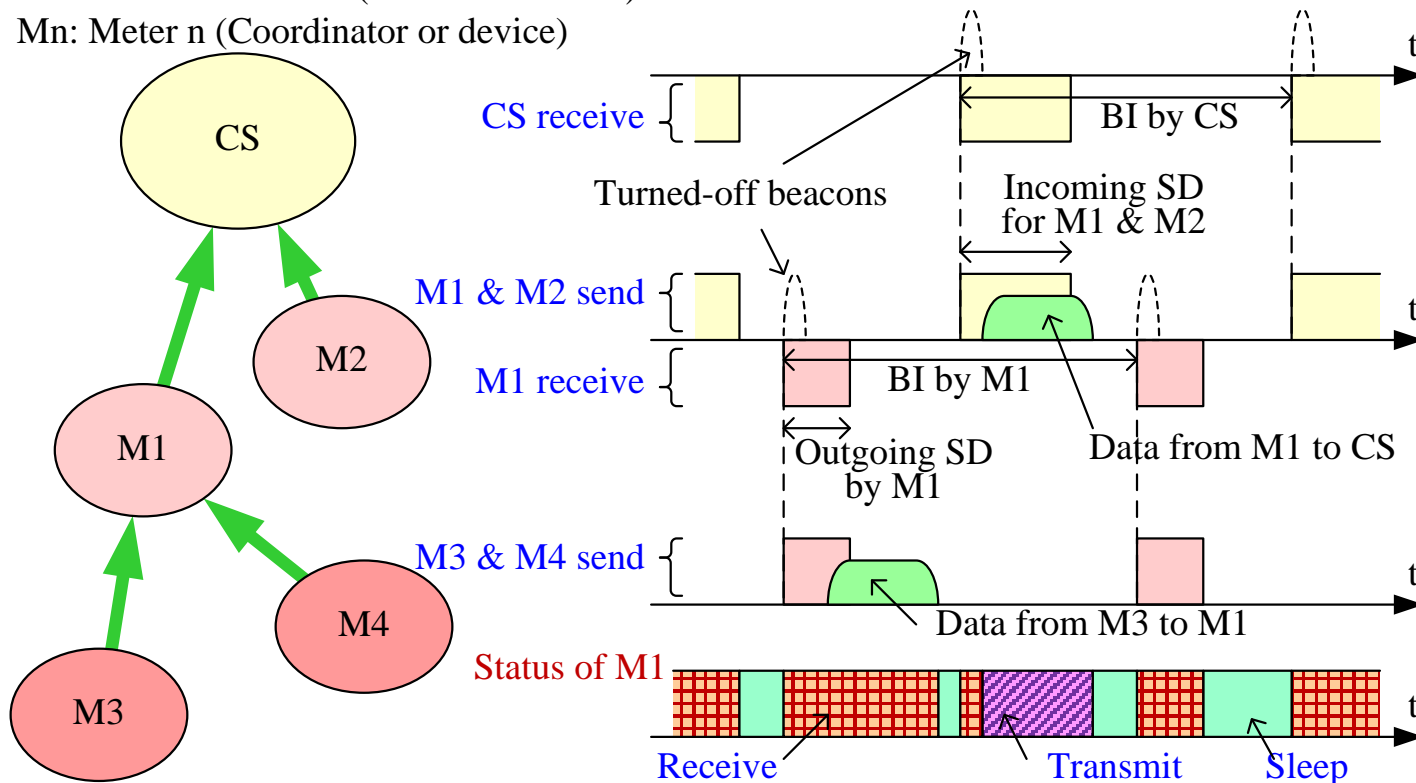

NICT's R&D on SUN(7): SUN radio terminal development

- SUN radio terminal development in 3 phases

- Phase 1: Basic small long-lived terminal

- ▶ First prototype of small terminal
- ▶ Original specifications are employed



- Phase 2: Test terminal for PHY/MAC investigation

- ▶ Basic PHY/MAC investigation assuming standard



- Phase 3: IEEE draft compliant SUN terminal

- ▶ IEEE draft compliant PHY/MAC
- ▶ Proof test including connection with meter/sensor



NICT's R&D on SUN(8): Basic small long-lived terminal

- Small long-lived terminal driven by AAA batteries
- Original specifications

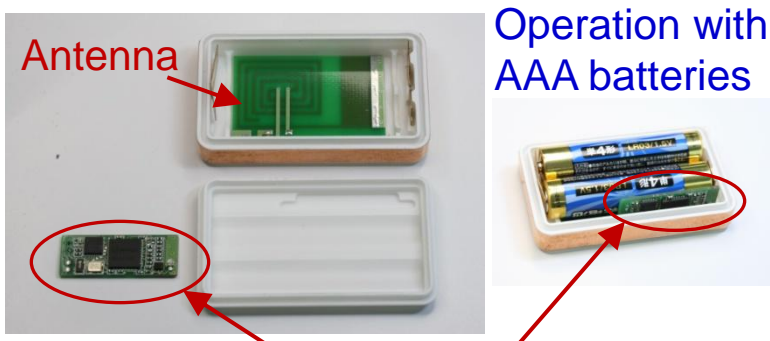

Operation with
AAA batteries

Radio circuit board

Specifications	
Frequency band	400 MHz
Transmission power	Max 10dBm (antenna input power)
Modulation scheme	2GFSK
Signal bandwidth	32 kHz
Data rate	19.2 kbps
MAC scheme	CSMA/CA with sleeping period
Routing scheme	Based on autonomous TREE topology construction
Beacon interval	1s
Active period	3.5ms
Data frame length	12.5ms

NICT's R&D on SUN(9): Test terminal for PHY/MAC investigation #1

- Experimental system for detailed PHY/MAC investigation assuming IEEE 802.15.4g standard
- Basic evaluations of active/inactive period employment
- Outdoor experiments



All-purpose terminal that enables detailed examination of the PHY/MAC parameters

Relay and routing control for data frames



Reduced function small terminal (Only 2GFSK on 400MHz band)

	All-purposed terminal	Reduced function small terminal
Frequency	400/950MHz	400MHz
Transmission power	10dBm	
Diversity	Selective diversity on receiver	No diversity
Modulation scheme	2GFSK/4GFSK	2GFSK
Data rate	50/100/200/400kbps	50/100/200kbps
Payload length	~1500octet	
MAC scheme	CSMA/CA with sleeping period	
Routing scheme	Based on autonomous TREE topology construction	

NICT's R&D on SUN(10): Test terminal for PHY/MAC investigation #2

- Data frame collection experiments using ten small terminals are conducted. Autonomously constructed tree topology with multi-hop transmission enables frames from all terminals to reach the collection node. On the other hand, star topology with only direct transmission fails that in case of terminals under severe locations

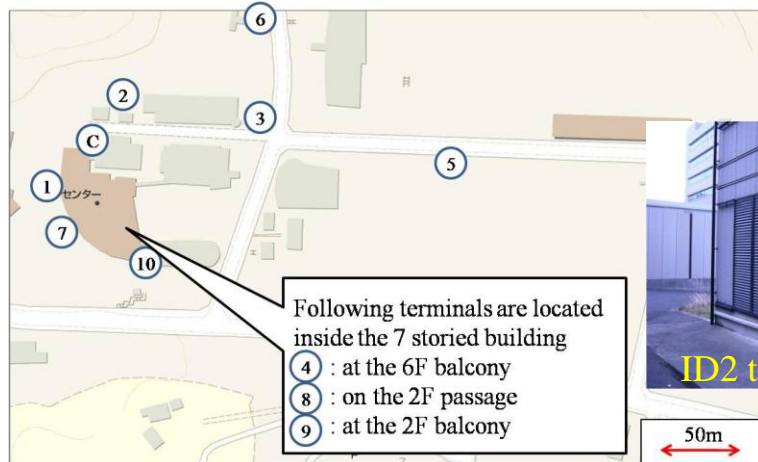

Following terminals are located inside the 7 storied building

- ④ : at the 6F balcony
- ⑧ : on the 2F passage
- ⑨ : at the 2F balcony



ID2 terminal

50m

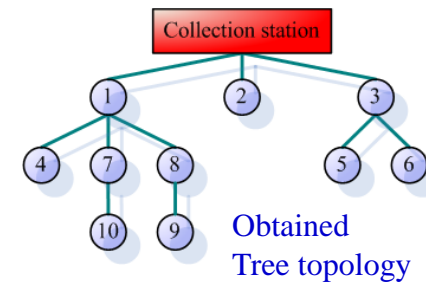

Experimental setup	
Frequency	400MHz
Transmission power	10dBm
Modulation scheme	2GFSK
Data rate	100kbps
Payload length	100octet
Frame arrival interval	48s
MAC scheme	CSMA/CA with sleeping period
Beacon interval	3s
Active period length	0.4s
Routing scheme	Based on TREE topology construction

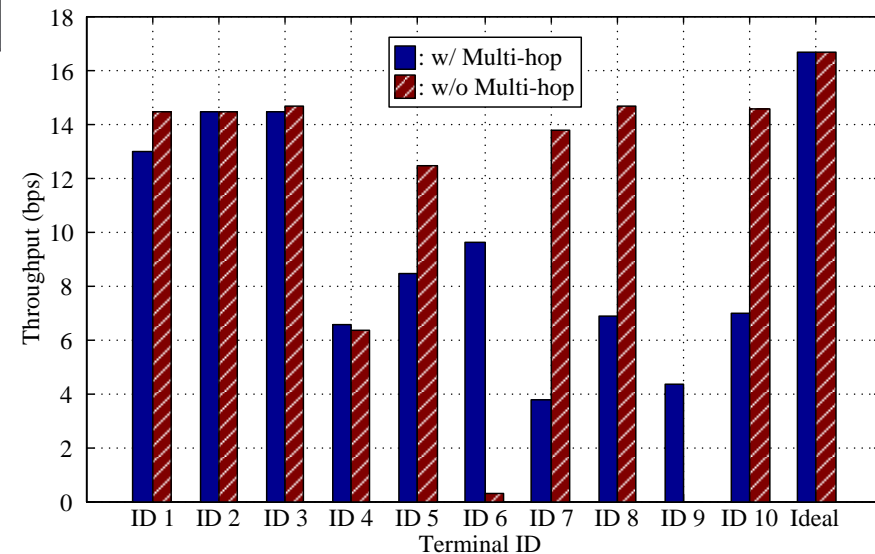

NICT's R&D on SUN(11): IEEE draft compliant SUN terminal #1

- IEEE802.15.4g/4e draft compliant radio terminal
- LE-Superframe
- Proof test with meter/sensor connected

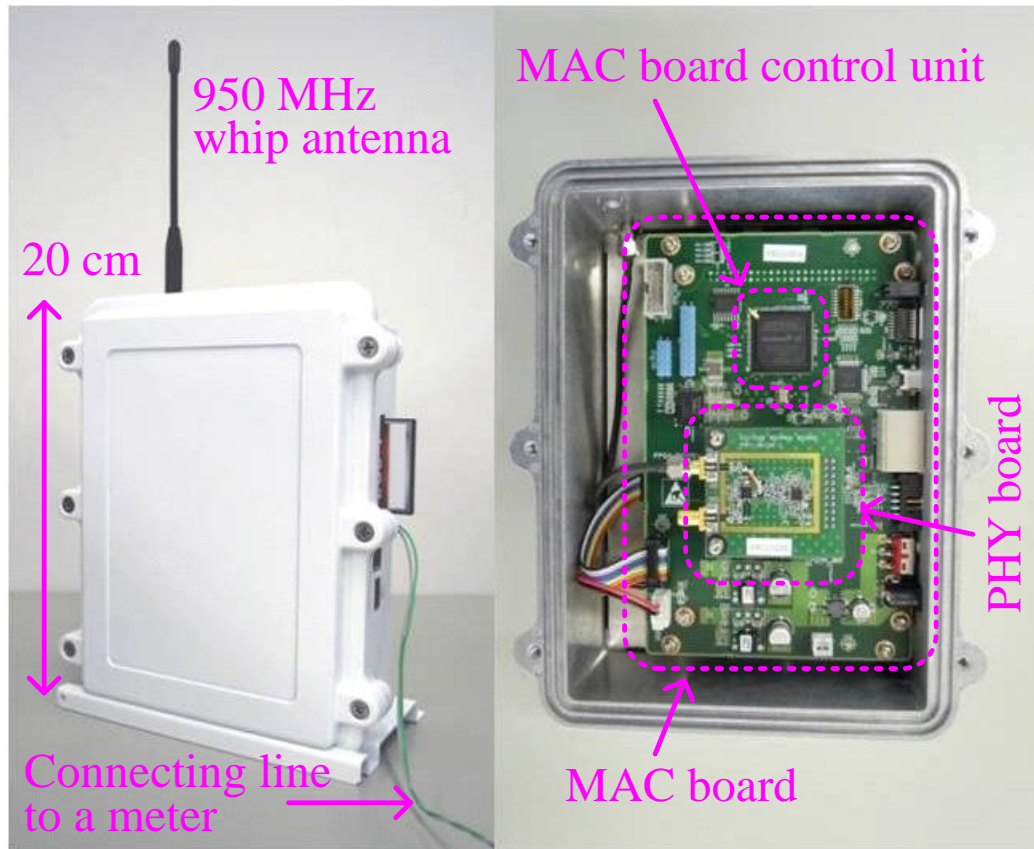

Specifications	
Frequency	953MHz
Transmission power	10dBm
Modulation scheme	2GFSK
Data rate	50/100/200kbps
Payload length	~1500octet
MAC scheme	IEEE 802.15.4e
Routing scheme	TREE routing

NICT's R&D on SUN(12): IEEE draft compliant SUN terminal #2

- Service area expansion by multi-hop transmission are confirmed where up to 1500 octet data frames are exchanged

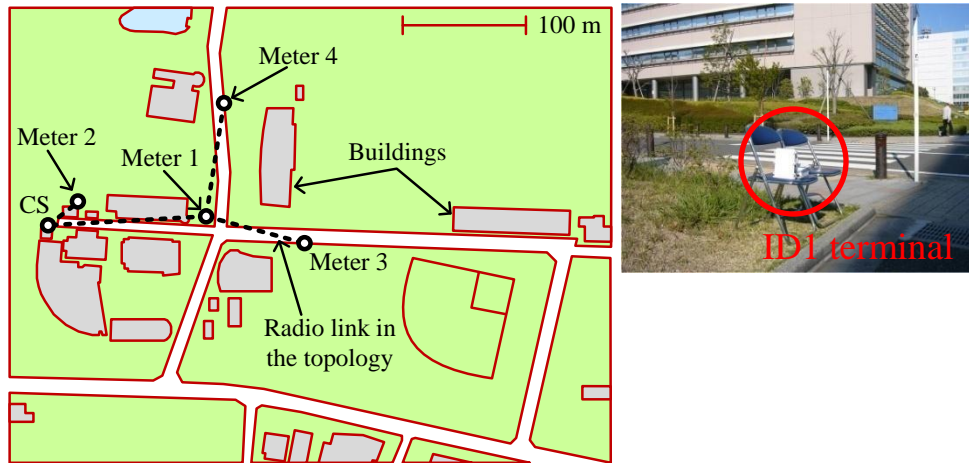

Experimental setup	
Frequency	953MHz
Transmission power	10dBm
Modulation scheme	2GFSK
Data rate	100kbps
Payload length	100/1500 octet
Frame arrival interval	60s
MAC scheme	IEEE 802.15.4e
Beacon interval	9.83s (BO=10)
Active period length	76.8ms (SO = 3)
Routing scheme	TREE routing

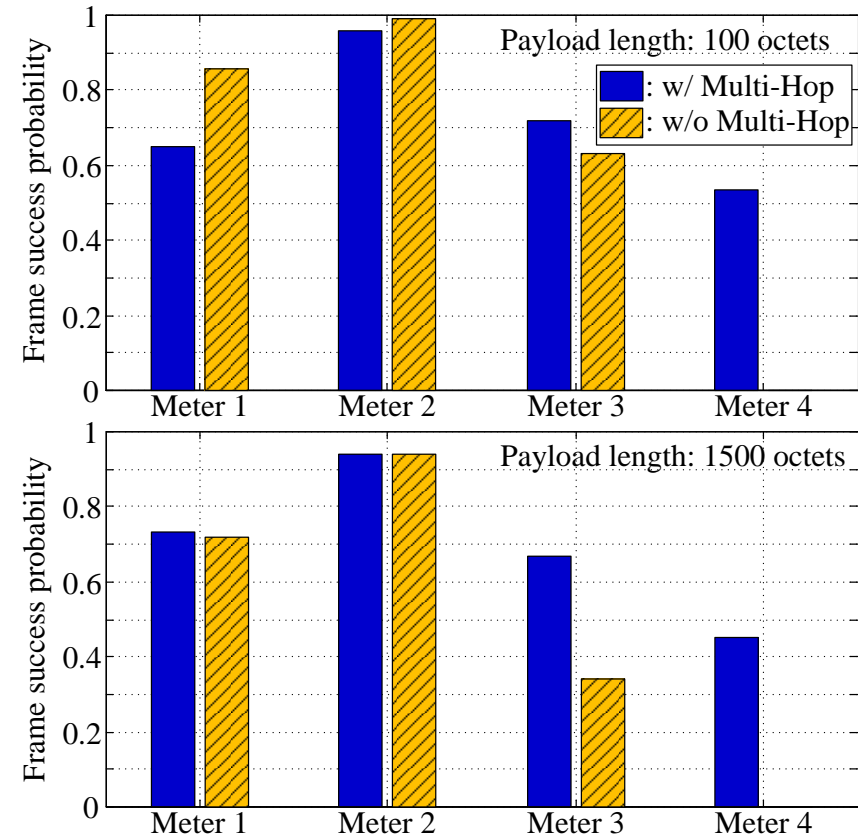

NICT's R&D on SUN(13): SUN applications with meter/sensor #1

- Meters connected SUN terminals that realizes effective metering data correction with visualizing energy consumption



スマートメータ 検針・制御システム

目録設定

SUNによる スマートメータ 検針・制御システム

No.	ID	受信時刻	検針時刻	メータ値
29	3	10:28:40	10:25:45	000004.813
28	1	10:28:30	10:28:08	000004.813
27	4	10:28:20	10:25:47	000006.177
26	2	10:28:10	10:25:51	000004.817
25	4	10:25:40	10:24:47	000006.177
24	3	10:25:20	10:24:45	000004.813
23	2	10:25:10	10:24:51	000004.817
22	3	10:24:40	10:23:45	000004.813
21	1	10:24:30	10:24:08	000004.813
20	4	10:24:20	10:23:47	000006.178
19	2	10:24:10	10:23:51	000004.817
18	4	10:24:00	10:23:47	000006.165

メータ 4

メータ1 メータ2 メータ3 **メータ4**

000004.813 000004.817 000004.813 **000006.177**

メータ5 メータ6 メータ7 メータ8

Tree-shaped relay topology that consists of a collection/ control station (ID0) and four meters (ID1~4) is displayed, where ID1 and 2 are both connected to ID0 and ID3 and 4 to ID2.

```

    graph LR
      ID0 --- ID1
      ID0 --- ID2
      ID2 --- ID3
      ID2 --- ID4
    
```

The time data is received by ID0 and read on the meter respectively

Meter data [m³] read on the four meters are received by the collection/ control station (ID0) and are displayed

NICT's R&D on SUN(14): SUN applications with meter/sensor #2

- Dosimeters connected SUN terminals monitoring radiation dosage results
 - ▶ Effective monitoring of radioactive contamination in the areas surrounding nuclear power plants due to incidents caused by major earthquakes

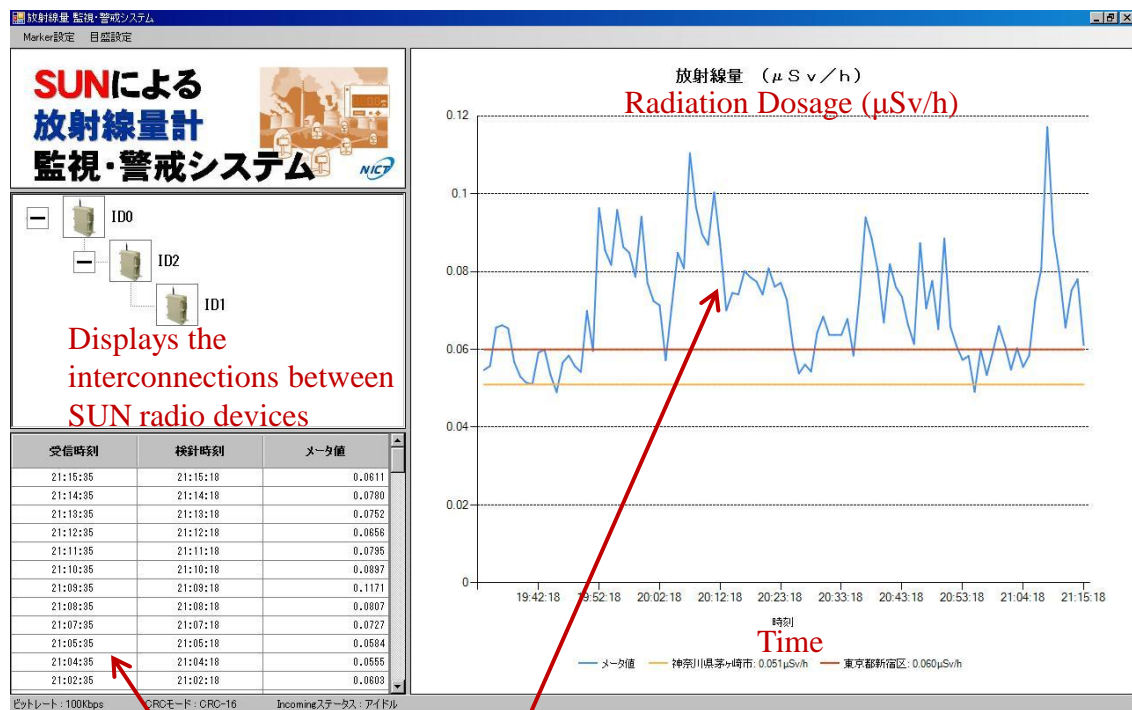

History of Received Measurement Values

Temporal Change in Received Measurement Values (Blue Line)

WAN-part activities

NICT's R&D on WAN(1): WAN overview

Inter-system networks

Wireless networks

Base stations

Wireless router

Terminals

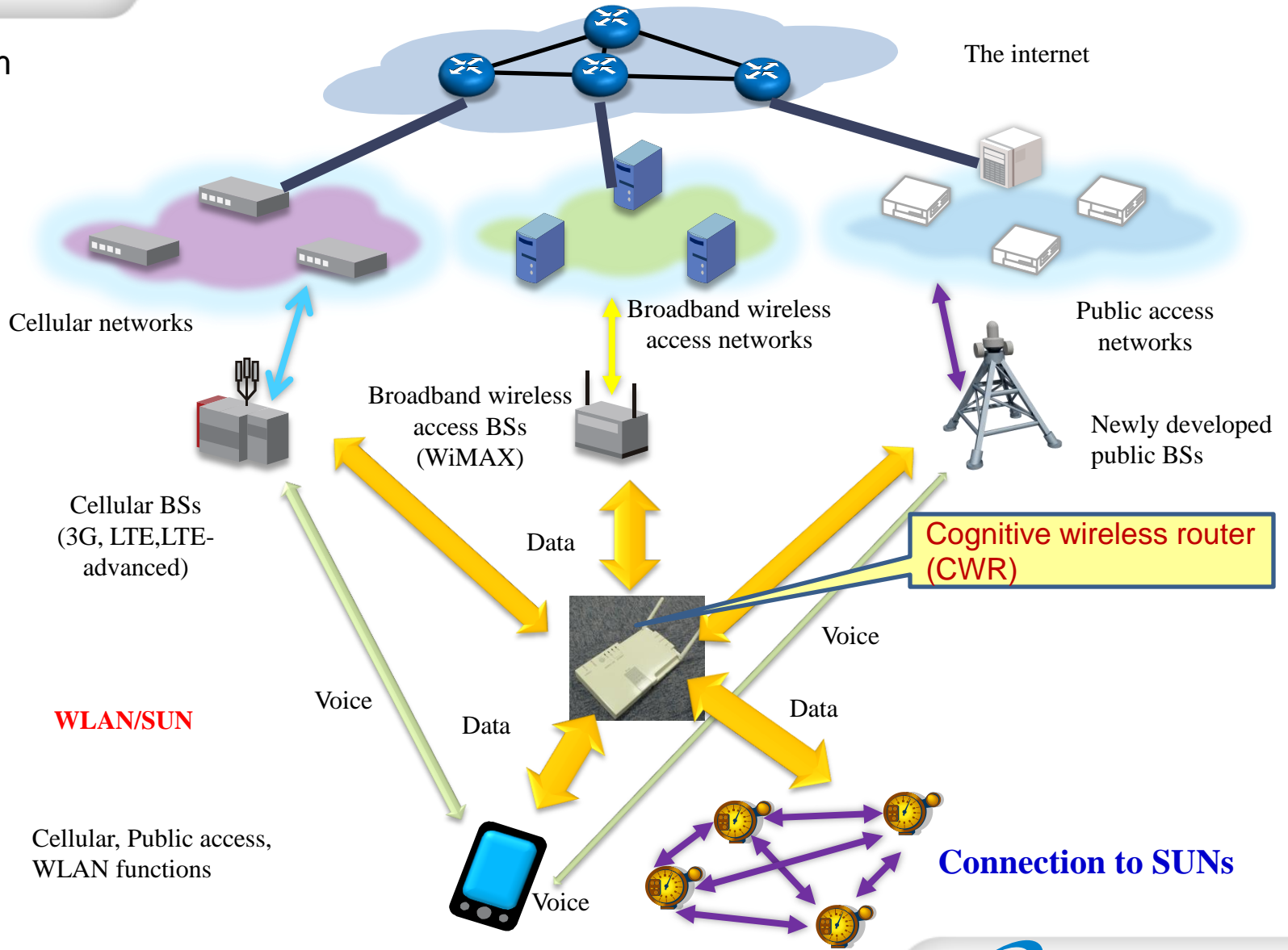

WLAN/SUN

Cognitive wireless router (CWR)

Connection to SUNs

NICT's R&D on WAN(2): Cognitive wireless router (CWR)

- Cognitive base station for mobile wireless router (Press released on March 3, 2009)
 - ▶ Accommodates several RAN connection methods (WiFi, HSDPA, WiMAX, PHS, etc.)
 - ▶ Provides Internet connection to users behaving as a WLAN access point
 - ▶ Provides spectrum sensing information to network reconfiguration manager (NRM)
 - ▶ Chooses the best RAN in terms of user's preferences according to sensing information and network policy from NRM
 - ▶ Includes IEEE 1900.4 architecture that has been contributed by NICT
 - ▶ **This is the world-first prototype that includes IEEE 1900.4 based cognitive function proposed by NICT for heterogeneous network connections**

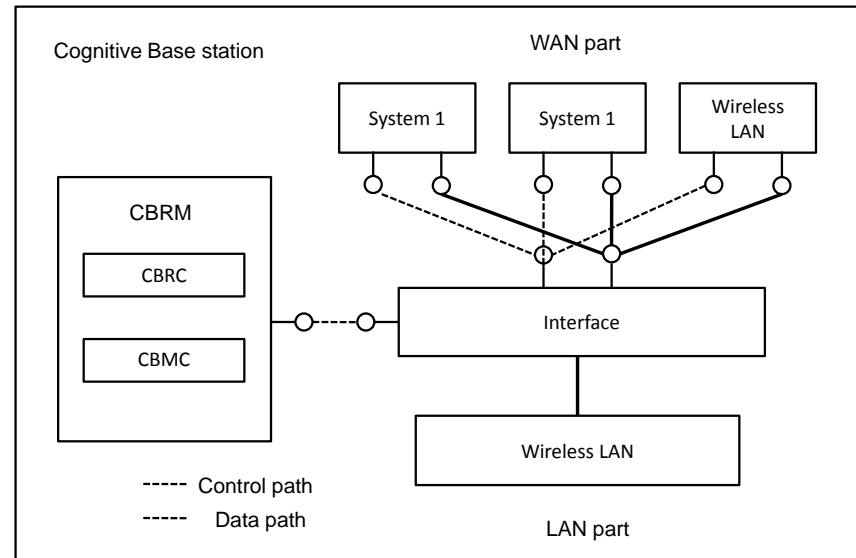

item	Specification
Sensing part	
Sensing frequency band	Dependent on communication systems connected via USB port (e.g. PHS, WiMAX, 3GPP, 3GPP2)
Wide Area Network part	
Supported communication systems	PHS, WiMAX, 3GPP, 3GPP2
Radio access network (RAN) selection framework	IEEE 1900.4 compliance
Local Area Network part	
Communication frequency band	2400M~2497MHz
Communication bandwidth	20 MHz
PHY	OFDM (52 carrier, 48 data subcarriers, 4 pilot subcarrier)
PHY frame format	802.11a compliance
MAC protocol	802.11a based MAC
Output power	Maximum 10 dBm

NICT's R&D on WAN(3): A cognitive wireless network

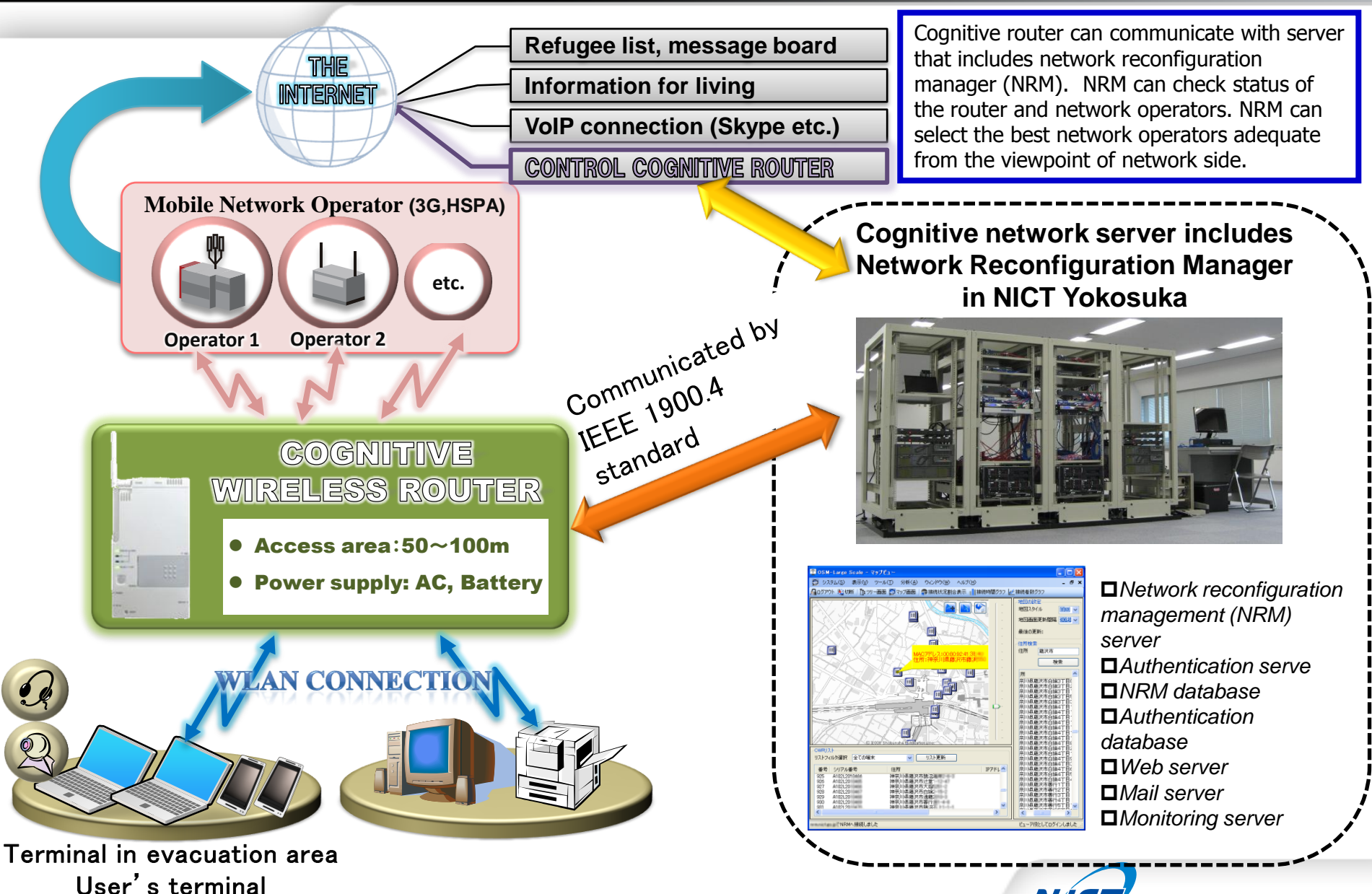

Cognitive router can communicate with server that includes network reconfiguration manager (NRM). NRM can check status of the router and network operators. NRM can select the best network operators adequate from the viewpoint of network side.

Cognitive network server includes Network Reconfiguration Manager in NICT Yokosuka

- Network reconfiguration management (NRM) server
- Authentication server
- NRM database
- Authentication database
- Web server
- Mail server
- Monitoring server

Communicated by IEEE 1900.4 standard

Terminal in evacuation area
User's terminal

NICT's R&D on WAN(4): Wide area wireless testbed

About 500 cognitive wireless routers are located in Fujisawa city, which are available for all people having WLAN cards

Tokyo

Reports from cognitive wireless routers are stored in the management systems, which controls suitable resource allocation for the routers

Fujisawa city

Yokosuka city

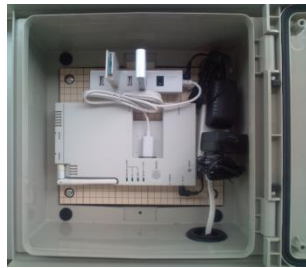

Universities, museums, schools, restaurants, hospitals, shopping-malls and sports-centers

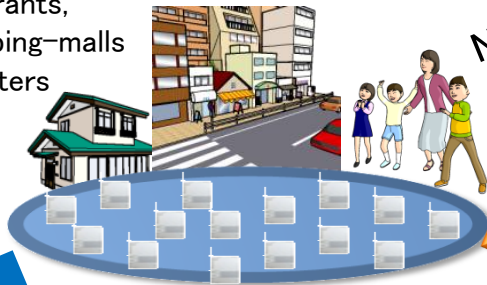

500-cognitive wireless routers



Called for users who use the router with their own PC

Status of cognitive wireless routers can be monitored by a viewer from the Internet

NICT proposing radio resource management scheme is operational



Management systems

Network Reconfiguration Manager in NICT Yokosuka

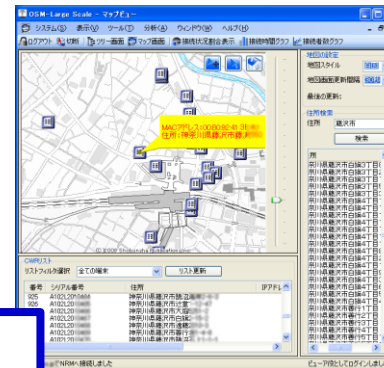

- Network reconfiguration management (NRM) server
- Authentication server
- NRM database
- Authentication database
- Web server
- Mail server
- Monitoring server

NICT's R&D on WAN(5): CWRs have been launching in the disaster places by earthquake

As of Sep. 17

All cognitive routers are connected a cognitive network server in NICT Yokosuka

Cognitive network server includes Network Reconfiguration Manager in NICT Yokosuka

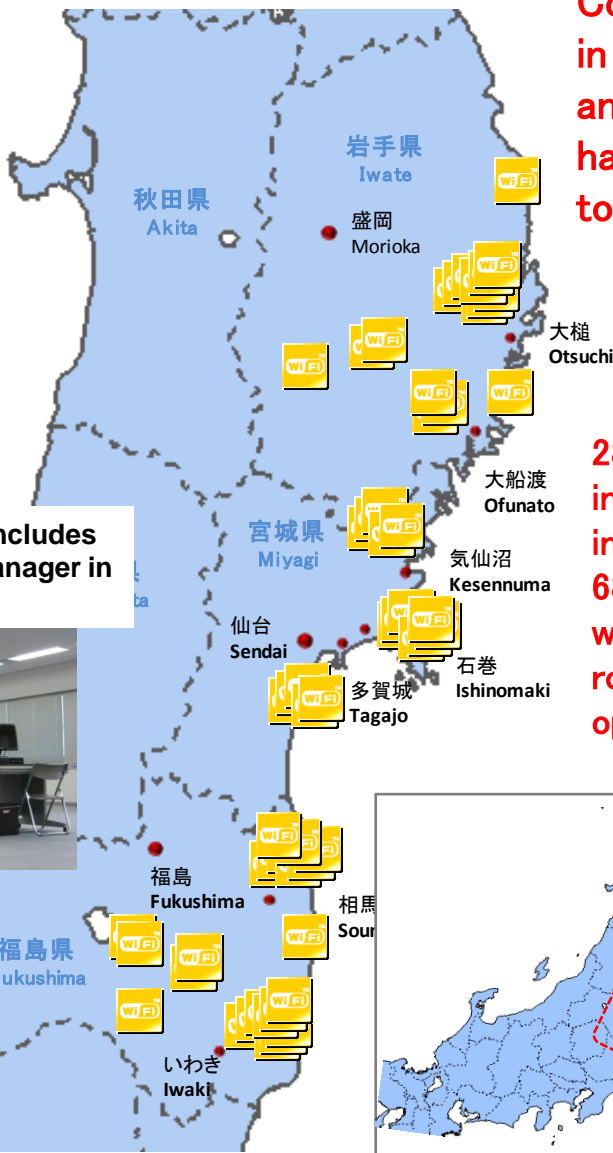

Cognitive wireless routers have been installed in disaster place since April 2011. The routers and its supported cognitive wireless network have been operated without any trouble as of today.

28 in IWATE, 17 in MIYAGI, 23 in FUKUSHIMA, 68 cognitive wireless routers are operational



Launched cognitive router

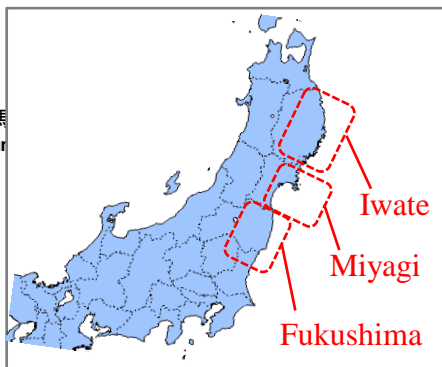

Conclusions

- This presentation summarizes NICT's R & D activities on Smart Utility Networks as in the following topics:
 - ▶ Outline of Smart Utility Networks
 - ▷ Use image consisting of SUN-part and WAN-part
 - ▷ SUN requirements
 - Long-lived capability
 - Service area expansion
 - Further requirements
 - ▶ SUN-part activities
 - ▷ Japanese trend on IEEE 802.15.4g standardization
 - Non FH PHY with MPM
 - New allocation in 920 MHz band
 - Low energy support
 - ▷ NICT's activities to realize SUN
 - Proposal on long-lived multi-hop network
 - IEEE 802 15.4g terminal development and proof test
 - ▶ WAN-part activities
 - ▷ NICT's activities to realize WAN
 - Cognitive radio router for advanced WAN
 - Wide area testbed by employing large number of routers
 - Operation in disaster situation
 - ▶ Conclusions

Further advanced SUN-WAN harmonization and proof tests as the next phase !