

Generic Serial Convergence Function (GSCF)

Rev. 1: 2022-08-24: changes to Slide 17-22; new Slide 23; other minor changes
Rev. 0: 2022-08-17

Roger Marks
(EthAirNet Associates)
roger@ethair.net

+1 802 capable

2022-08-24

Copyright policy note: “Q: Do I need permission if I am using IEEE standards for comparison or discussion only? A: IEEE SA Working Groups are permitted to present (i.e., display during a Working Group meeting) and review information from an approved IEEE standard.”

- <https://standards.ieee.org/faqs/copyrights/working-group-and-activity-chairs/>

See also

- *Ambiguity in the MAC Service*
 - Roger Marks, 2022-06-15
- *CSD Compatibility Criterion for Cut-Through Forwarding*
 - Roger Marks, 2022-06-22

802.3 NEA on CTF

- *IEEE 802.3 NEA Conclusion from the joint NEA / 802.1 Nendica meetings on cut-through forwarding (CTF).*
 - *The IEEE 802.3 Ethernet Media Access Control (MAC) and MAC Client service interface specified in IEEE Std 802.3-2022 only supports store and forward operation and is unable to support cut-through operation. To provide cut-through capability, a new definition of the IEEE 802.3 MAC is required.*
 - *Source: [IEEE 802.3 New Ethernet Applications \(NEA\) Ad Hoc Closing Report, 2022-07-15](#)*

802.1 on CTF

- *IEEE 802.1 Conclusion from the joint NEA / 802.1 Nendica meetings on cut-through forwarding (CTF).*
 - *No consensus on what supporting MAC an 802.1 Cut-Through Forwarding standard would use and, if needed, where to specify it.*
 - *Source: [Cut-Through Forwarding status update from Nendica perspective](#)*

Addressing the MAC Roadblock

- Approach:
 - Bypass the MAC roadblock by eliminating the MAC.
 - This could help enable cut-through forwarding (CTF).
 - Perhaps other advantages might also result.
- Presumption
 - collision-free LAN
 - support for only for full-duplex
 - medium access needs no control

Architectural Model per 802.1Q

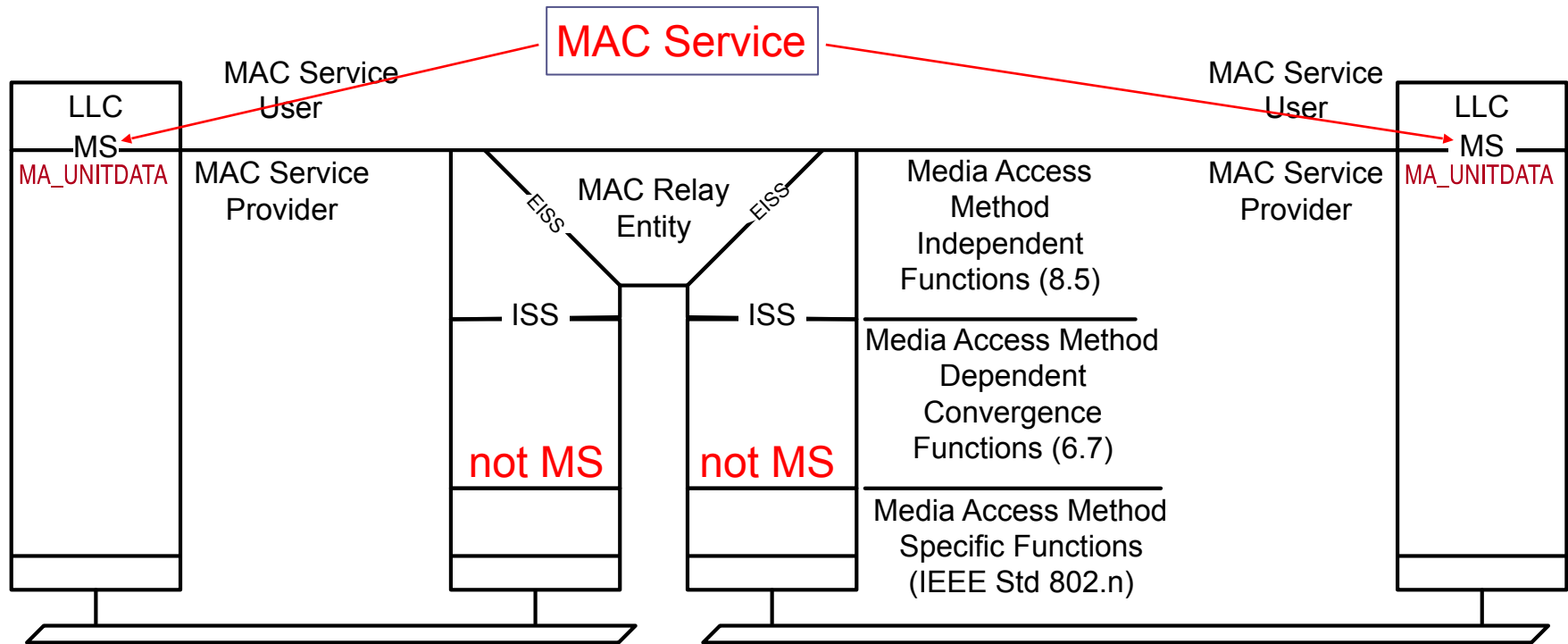

Architectural Model per 802.1Q - interface details

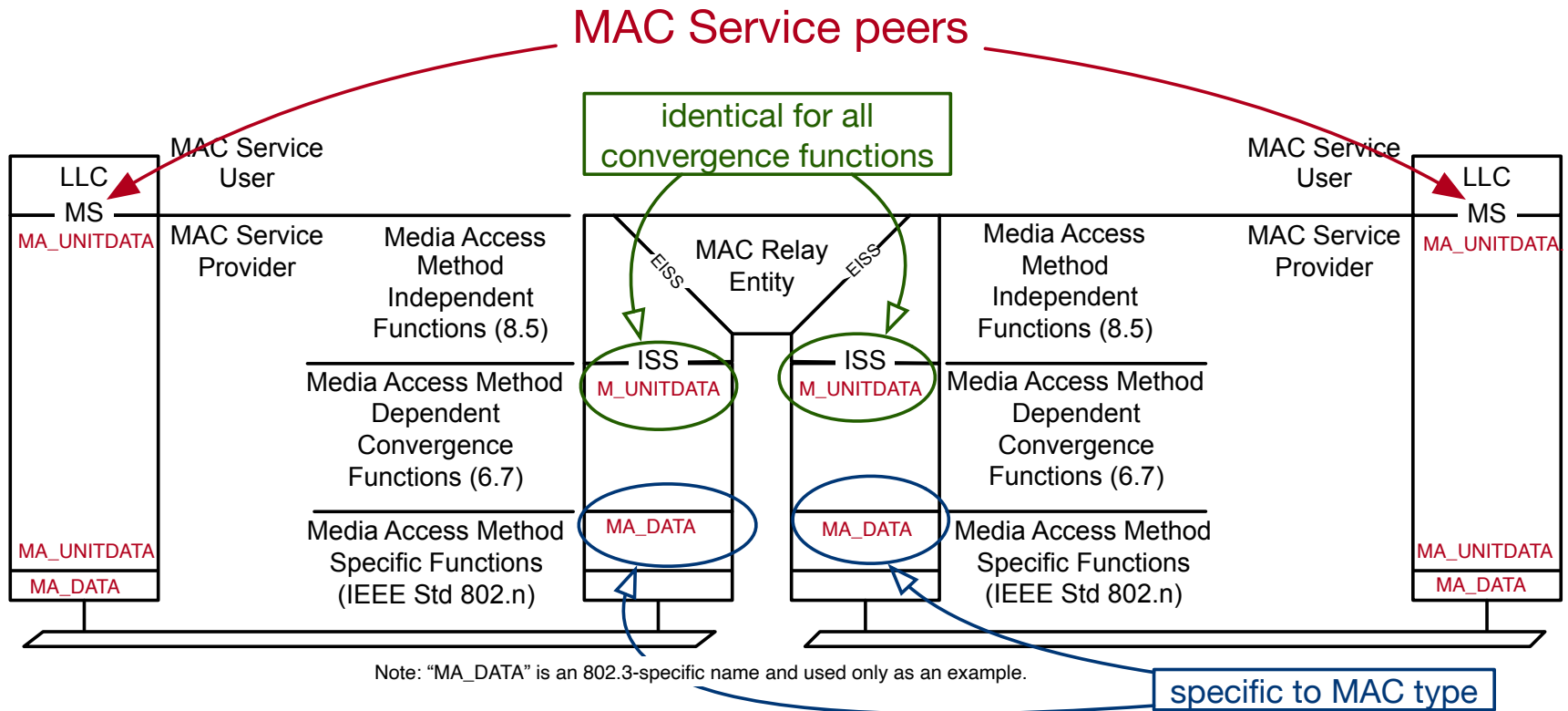

Architectural Model with GSCF

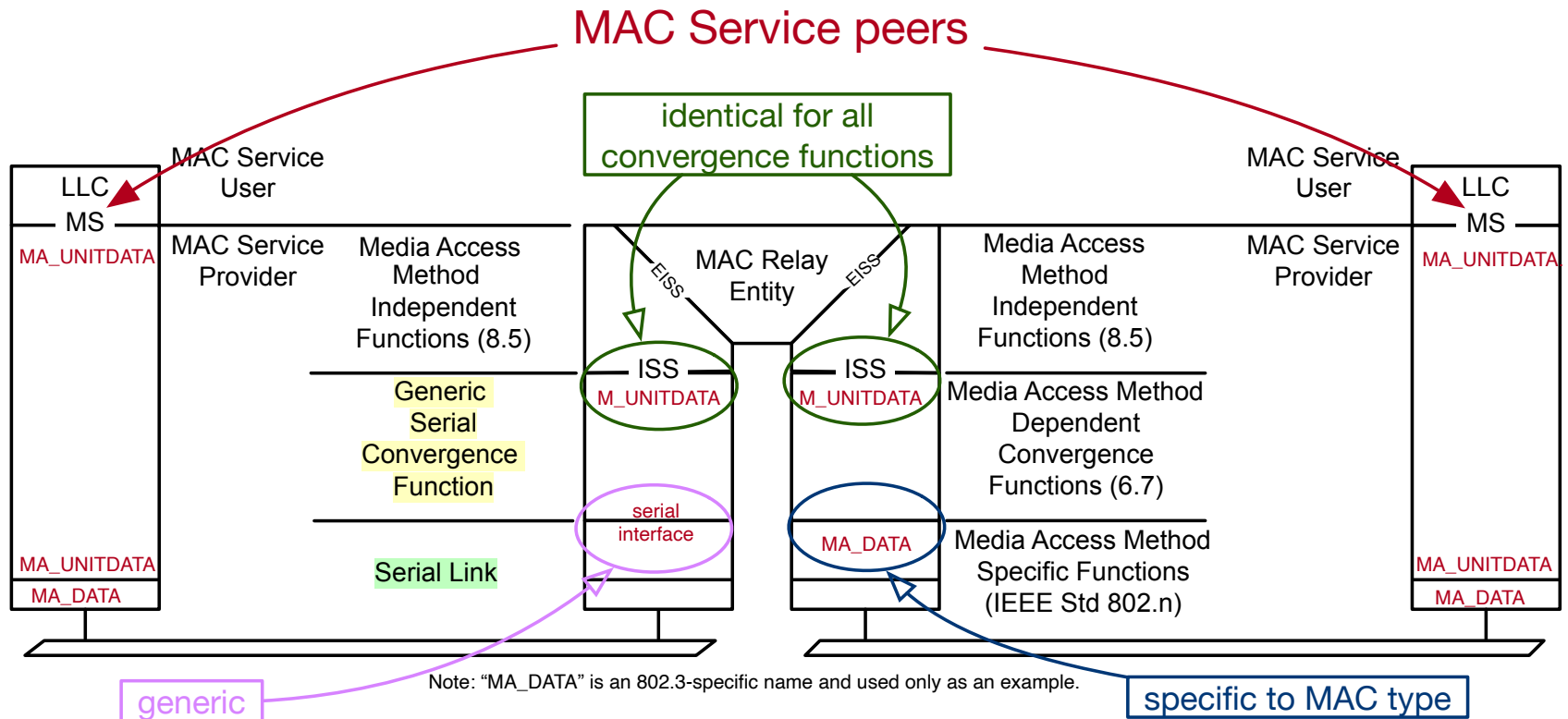

GSCF can look, to the ISS, just like every Media Access Method Dependent Convergence Function.

802.1Q §6.15 *The ISS may be supported by other technologies that provide either an IEEE 802 MAC Service or an emulated IEEE 802 MAC Service. The technology is responsible for invoking an M_UNITDATA.indication with appropriate parameters (IEEE Std 802.1AC) for each received frame, and transmitting a frame in response to each M_UNITDATA.request.*

802.3 generic Reconciliation Sublayer

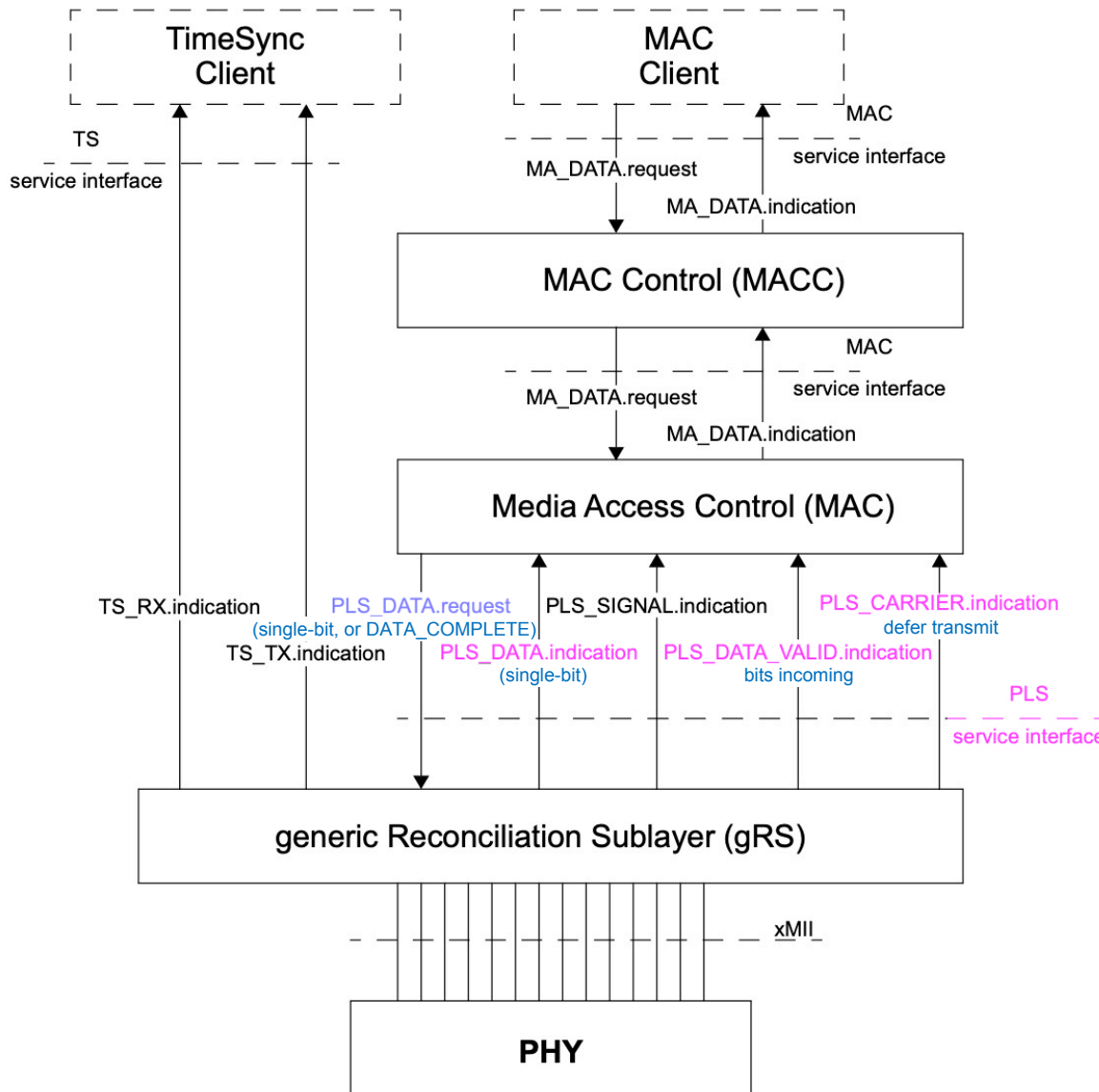

See 802.3 §90:

- “Ethernet support for time synchronization protocols”

optional Time Synchronization Service Interface (TSSI)... can be used to support protocols that require knowledge of packet egress and ingress time

(gRS) is used to denote any IEEE 802.3 Reconciliation Sublayer (RS) used to interface a MAC with any PHY supporting the TimeSync capability

“PLS” represents “Physical Signaling”

Figure 90–1—Relationship of the TimeSync Client, TSSI and gRS sublayer relative to MAC and MAC Client and associated interfaces

gRS to GSCF Interface: use PLS

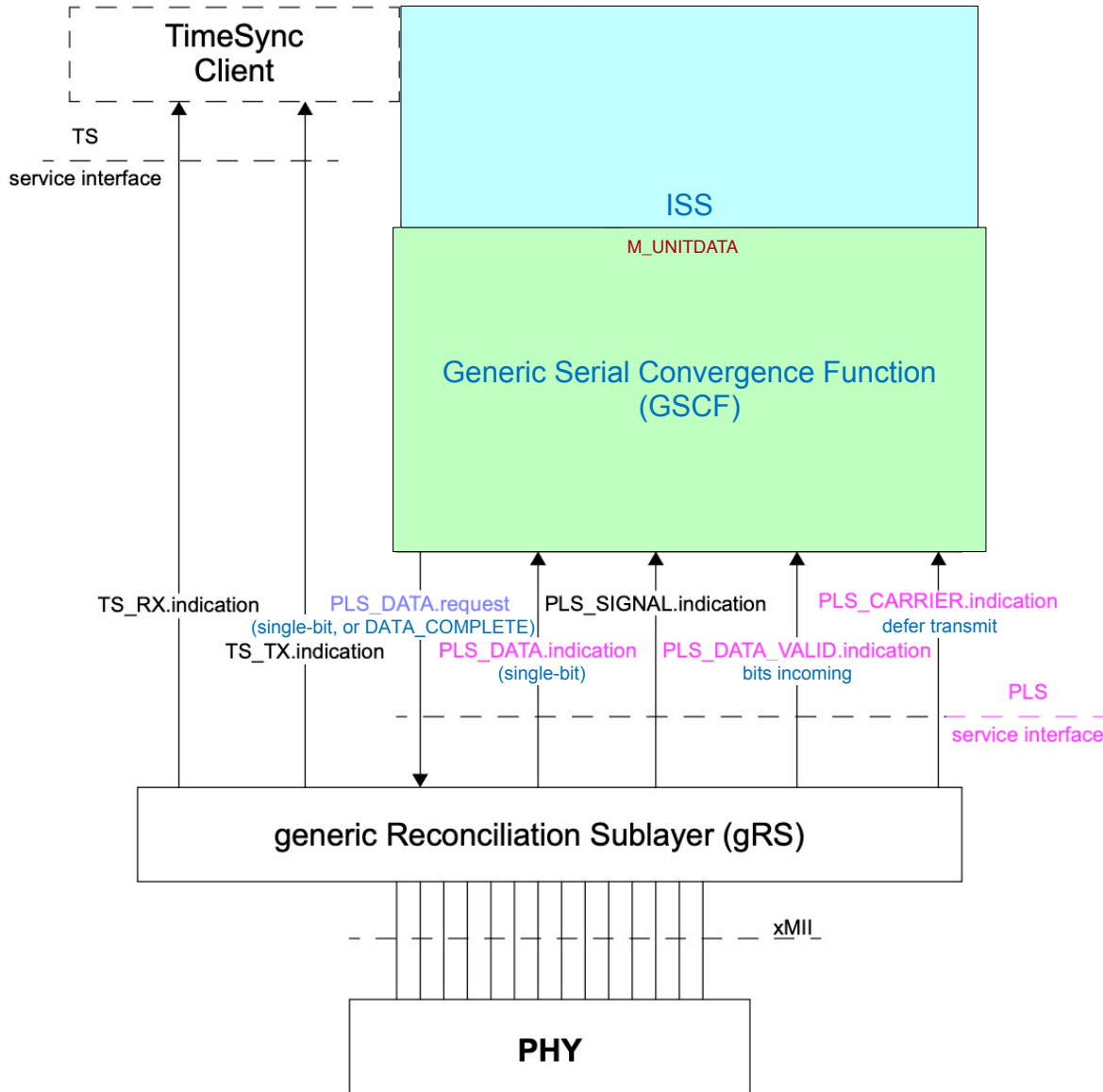

- Specify the lower GSCF interface to match PLS interface.
- Then GSCF interfaces to gRS, or anything behaving the same at PLS interface.

Figure 90–1—Relationship of the TimeSync Client, TSSI and gRS sublayer relative to MAC and MAC Client and associated interfaces

Building a GSCF: transmit

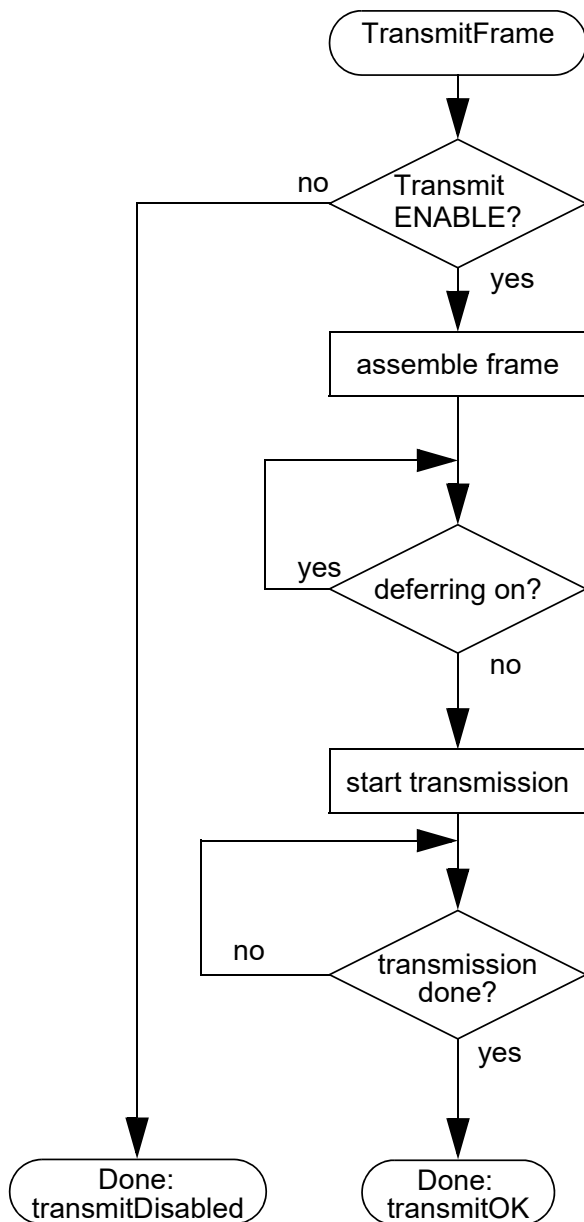

a) TransmitFrame

Note: the assembled “frame” includes Preamble and Start Frame Sequence. These are in the MAC, not the PHY!

Even the interframe gap is in the MAC! This is included in “deferring”.

- On the transmit side, what CSCF functions are needed?
- Consider as an example the 802.3 full-duplex MAC transmit functions.

Figure 4A-2a—Control flow summary

GSCF Transmit to LAN - schematic

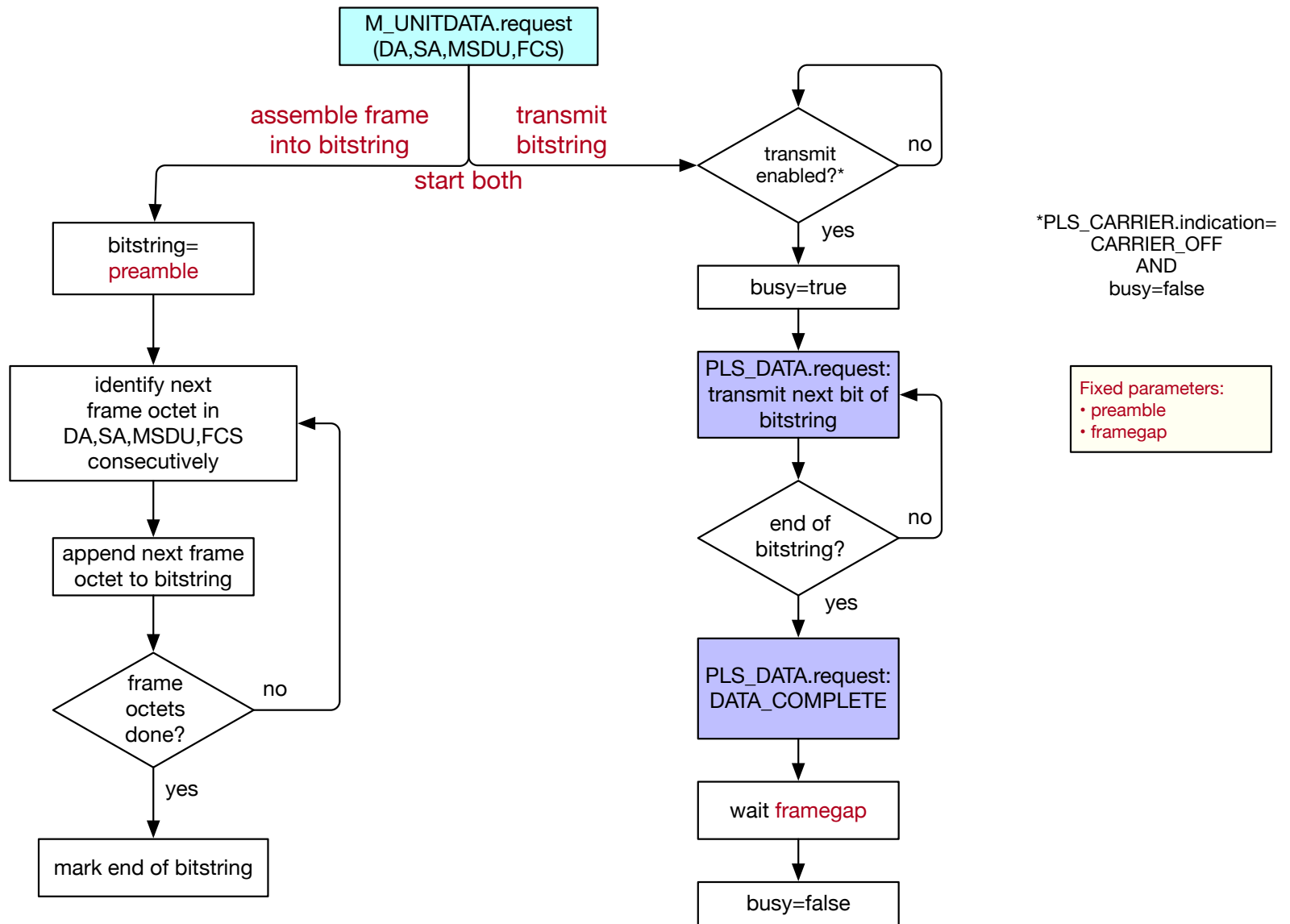

Building a GSCF: receive

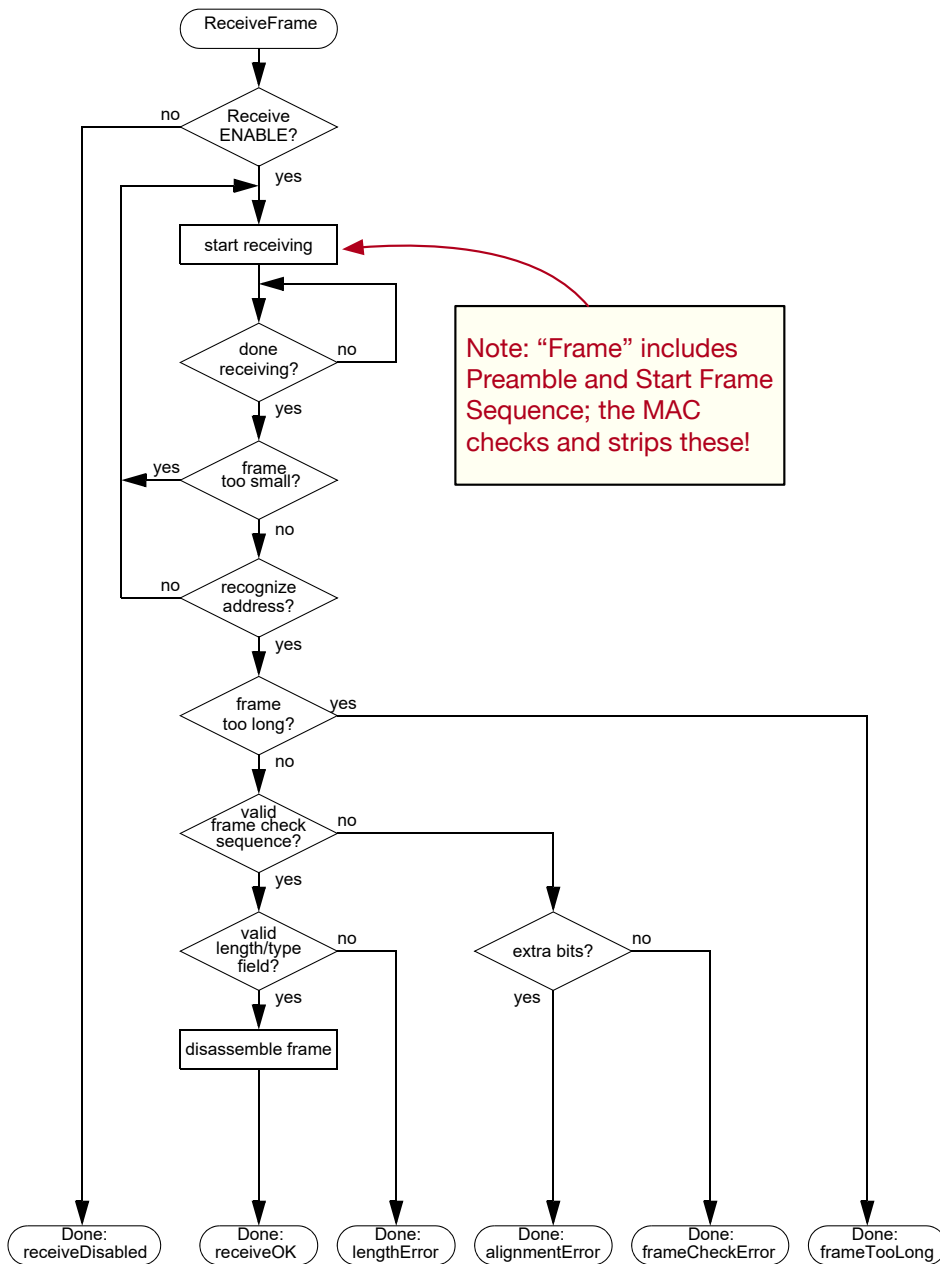

b) ReceiveFrame

Figure 4A-2b—Control flow summary

- On the receive side, what CSCF functions are needed?
- Consider as an example the 802.3 full-duplex MAC receive functions.

GSCF Receive from LAN - schematic

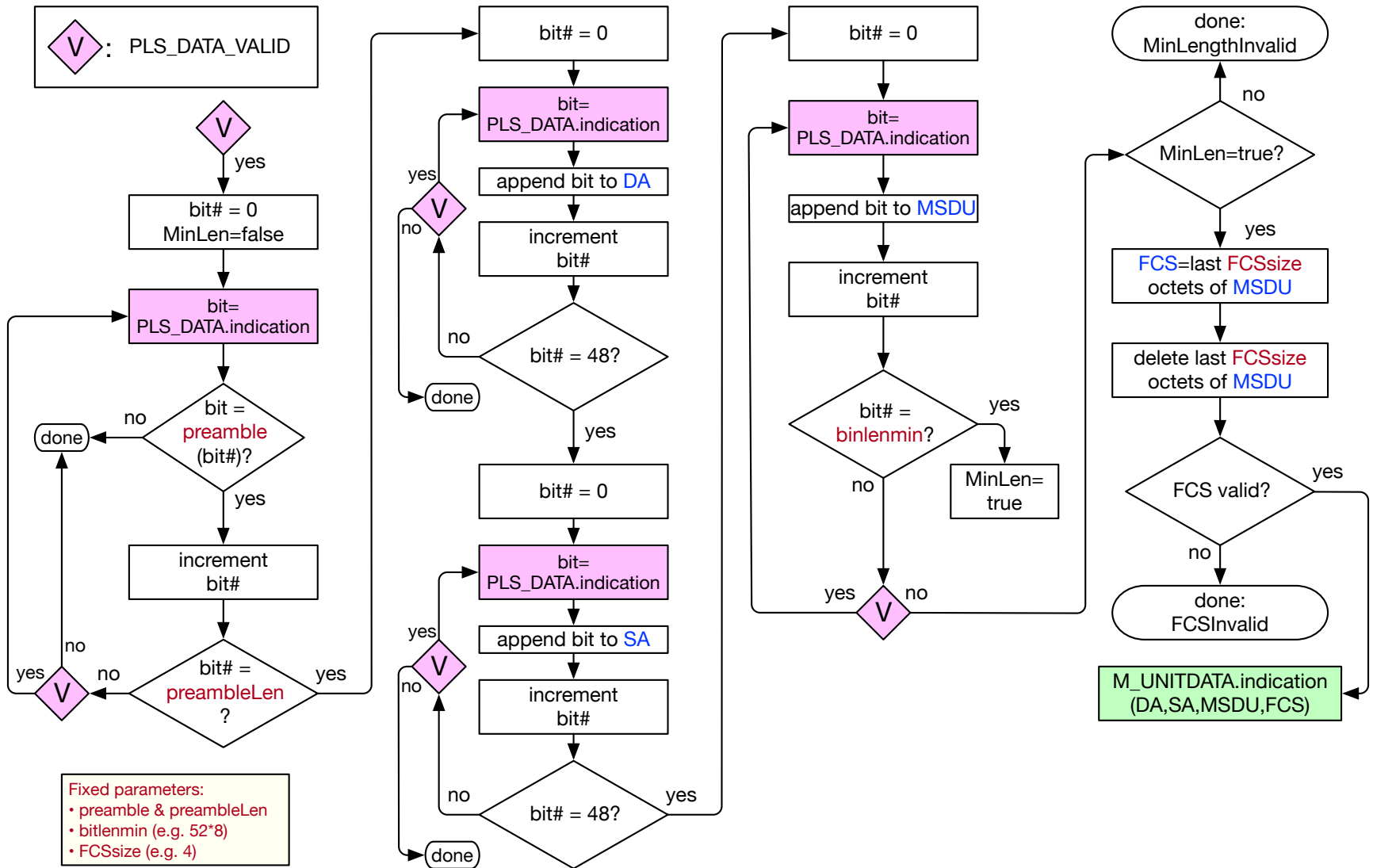

Sufficient to support CTF?

- GSCF Receive transfers frame in M_UNITDATA.indication
 - assembles bitstring a bit at a time
 - identifies frame fields as they are completed
 - Does it matter to the standards if the indication to ISS is expressed as a sequence of frame fields and frame field octets? Seems not.
- GSCF Transmit transfers frame in M_UNITDATA.request
 - assembles bitstring an octet at a time
 - transmits bits while bitstring is loaded
 - Does it matter to the standards if the request to GSCF is expressed as a sequence of octets? Seems not.
- The sequential expression of M_UNITDATA.request and M_UNITDATA.indication appears consistent with the relevant existing standards (i.e. 802, 802.1Q, 802.1AC).
 - However, the sequential processes can also be formalized.

New GSCF/ISS Messages for CTF

- To more formally support CTF, could add primitives at the ISS/GSCF interface:
 - `frame_on`: TRUE when ISS is transferring frame octet data to GSCF
 - `M_UNITDATA[octet].request(byte)` transfers the octet *byte*
 - `frame_on` FALSE when sequence of frame octets ends
 - `M_UNITDATA[da].indication`, `M_UNITDATA[sa].indication`, and `M_UNITDATA[msdu].indication` transfer an octet *byte* of DA, SA, and FCS, respectively, from GSCF to ISS, along with an octet order identifier *byte#*
 - `M_UNITDATA[fcs].indication` transfers FCS *fcs* and FCS status *status* to ISS
 - *status* is true for valid FCS and false for invalid FCS

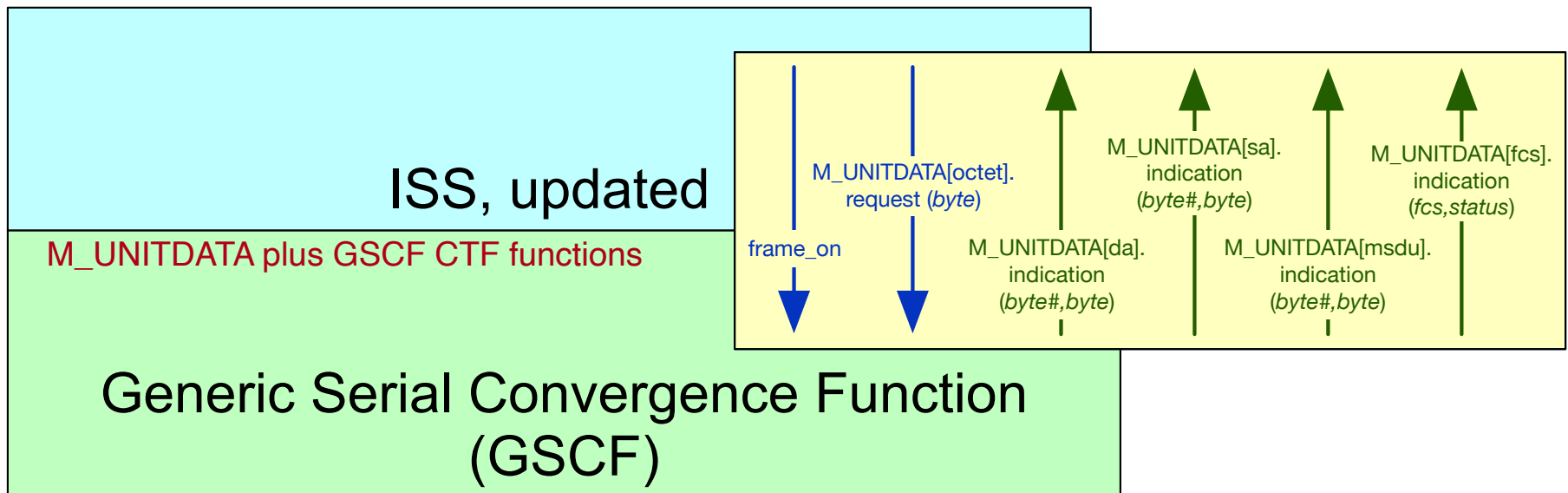

GSCF Transmit with CTF - schematic

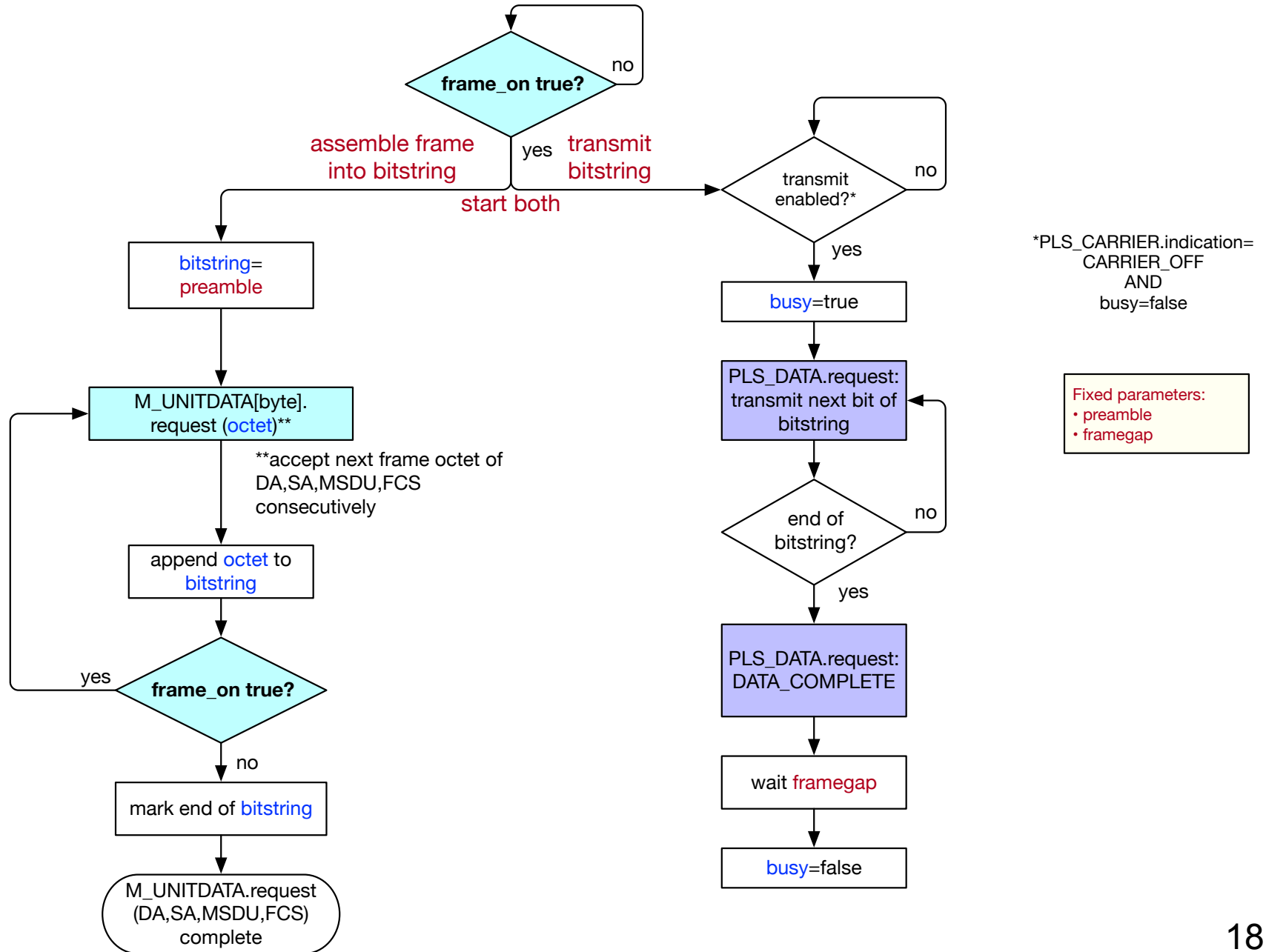

GSCF Receive timing

- GSCF Receive needs to delay MSDU indication by at least *FCSsize*, so FCS data is not passed to ISS as MSDU data
 - also essential if GSCF is responsible to validate FCS
- Additional delay is required GSCF is responsible to ensure a minimum frame size.
 - need to defer until receipt of the minimum-sized frame
 - allows bridge to proceed without checking for runt frames

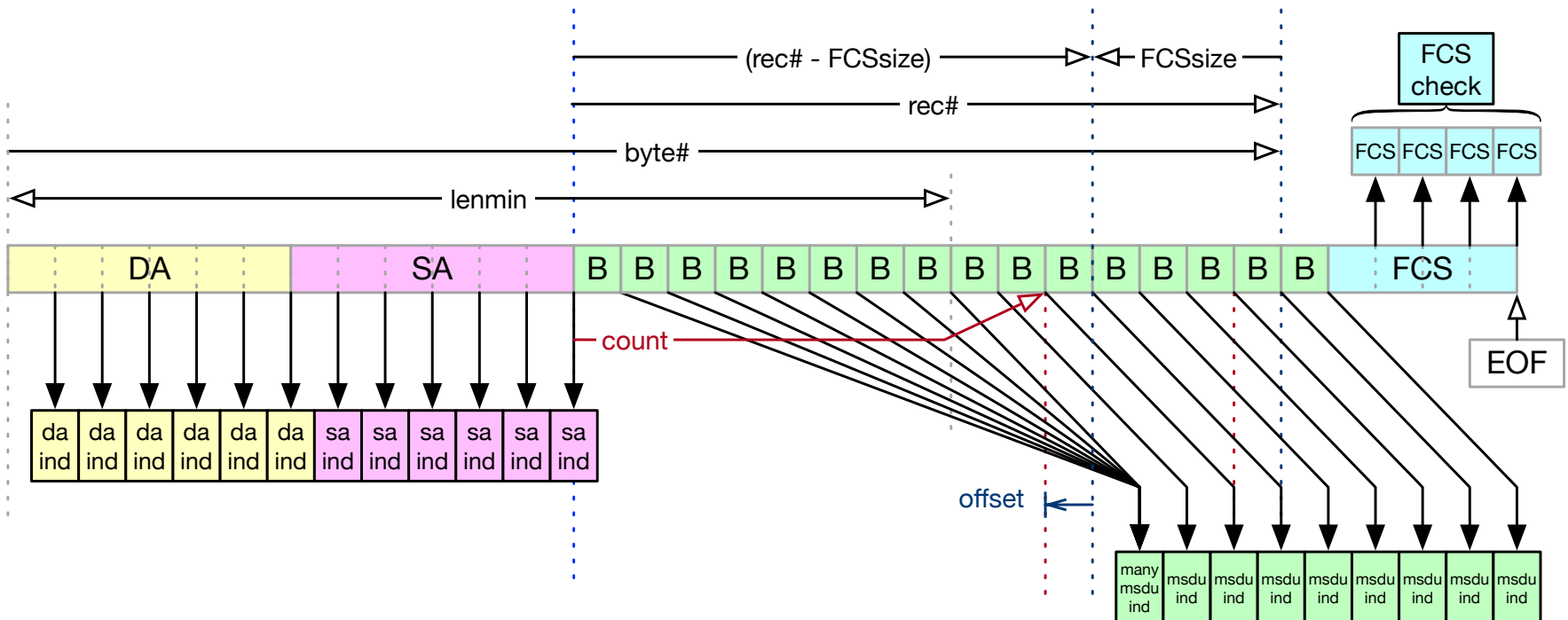

GSCF Receive with CTF - schematic

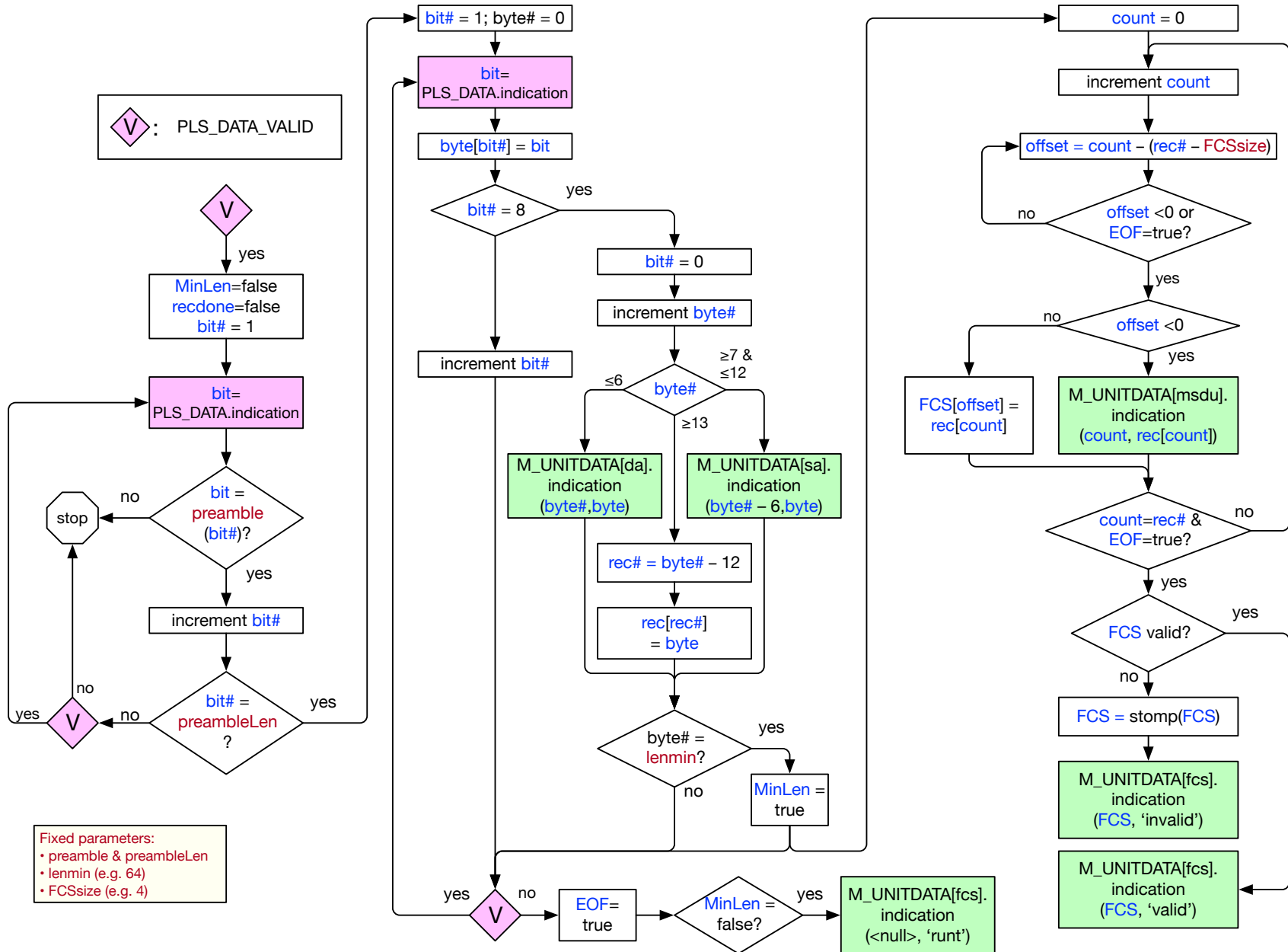

Bridge Behavior

- Not all frames can be forwarded with CTF by bridge.
 - For example, may defer due to busy egress port.
 - In some scenarios, the bridge may be assigned to selectively cut-through or store-and-forward frames based on specified characteristics.
 - This would need to be specified separately from GSCF.
- GSCF Receive and GSCF Transmit do not need to know how frame is forwarded; e.g. whether forwarded in deferred.
 - If the bridge receives **M_UNITDATA[fcs].indication(FCS, 'false')** before transmitting **lenmin** bits:
 - Drop and stop transmission; receiver will discard frame as a runt.
 - Otherwise, if the bridge receives **M_UNITDATA[fcs].indication(FCS, 'false')** before completing GSCF Transmit, then:
 - Stop transmission but add a stomped FCS covering transmission
 - transmitted frame will still be errored, but at least it will be shorter.

How Generic is GSCF?

- 802.3 needs
 - interframe gap inserted on transmit
 - 8 octets of preamble inserted on transit
 - technically, 7 of preamble plus 1-octet start frame delimiter
 - lenmin, lenmax
 - FCSsize
- GSCF is “Generic” to the extent that these parameters are customized to the LAN
 - Alternatively, a sublayer under the GSCF could be introduced.
 - This would add complexity to the description.
- If translation between LLC Encoding and Length/Type Encoding is necessary, it could be handled as an adaptation sublayer below the GSCF
- other custom scenarios could be included
 - e.g., exceptional bit ordering, postamble, etc.

GSCF is not “a MAC”

- It does not initiate or terminate the MAC service.
- It does not operate at a MAC SAP or have a MAC address.
- It is not a peer.
- It can function with a variety of MAC specs
- It does not match the functionality of any existing MAC.
 - e.g. it does not match the 802.3 MAC spec
 - though it includes some functions of the 802.3 MAC spec
- Its upper interface can be described by transactions that are more granular than a frame.
- The bridge using GSCF and CTF is closer to a repeater or hub.
 - But the bridging function makes it a selective repeater.

Summary

- GSCF can be a basis for a CTF architecture
 - may be useful without CTF
- GSCF can interwork with PLS interface
 - already supported by every 802.3 PHY
 - no amendment to 802.3 needed
 - non-Ethernet PHYs can adapt to it also

Recommendations

- Future CTF project proposals could consider GSCF as a basis of documenting feasibility
 - Should determine whether the existing ISS M_UNITDATA primitive specifications are compatible with using GSCF for CTF
 - If not, should consider supplementing ISS with the additional primitives based on transferring octets, DA, SA, and FCS
- Specification of GSCF could be developed as an amendment to IEEE Std 802.1AC.
 - That's where the “Media Access Method Dependent Convergence Functions” are specified.
 - Although the title is “Media Access Control (MAC) Service Definition,” the scope includes much more, including ISS specifications.
- CTF functionality at the bridge would be better specified elsewhere.