

# IEEE 802 Nendica Work Item Proposal: Network Stream and Flow Interworking

Roger Marks (EthAirNet Associates)

2020-01-22

# Summary

- This contribution proposes to initiate, within IEEE 802 Nendica, a new Work Item to develop an *IEEE 802 Nendica Report: Network Stream and Flow Interworking*

# Background Contribution

- Deterministic WLAN: A problem of scheduling and identifiers
  - Roger Marks (EthAirNet Associates), Antonio de la Oliva (University Carlos III of Madrid), and Lukas Wuesteney (Hirschmann)
  - 2019-11-11

# Example

- Interworking of streams
- Focus on DOCSIS and 802.11

## IEEE 802 Streams and Flows

Network traffic is increasingly managed as a set of flows rather than series of frames or packets.

IEEE 802 networks have developed and utilized flow concepts; e.g.:

- IEEE 802.11 Traffic Streams for QoS control
- IEEE 802.1 TSN Streams for time-sensitive networking (various standards)
- IEEE 802.1Qcz Congestion isolation
- IEEE 802.16 Service Flows for all traffic
- IEEE 802.15.4 use of Guaranteed Time Slots

Non-802 networks have developed and utilized flow concepts:

- IETF DetNet
- Software-Defined Networking, including OpenFlow
- DOCSIS Service Flows, carrying all traffic in Ethernet frame format
- Many Layer 3 networks
  - 3GPP Bearers
  - many IP cases

There is a need and opportunity to understand, and in some cases specify, the details regarding how these flows link or can be linked, so that IEEE 802 networks can be joined to each other, and to other networks, in efficiently providing end-to-end flow management and QoS.

## DOCSIS

DOCSIS is a standardized specification for hybrid fiber coax networks used as cable television and two-way telecommunications networks.

- Developed and maintained by CableLabs
- Point-to-multipoint architecture with a central bridge and controller (CMTS) communicating over a shared medium to cable modems (CMs)
- Traffic is carried in the form of Ethernet frames
- Traffic is carried in Service Flows that are preconfigured with Quality of Service requirements
- All Service Flow transmissions are scheduled by the CMTS
- Uplink scheduling is driven by a request/grant systems, mixing various scheduling services with differentiated polling methods, depending the QoS needs
- Architecture and MAC design has influenced other point-to-multipoint designs, including IEEE 802.16
- Low-Latency DOCSIS was introduced in 2019, address latency mainly with Active Queue Management and uplink scheduling improvements, targeting 99% latency on the order of 1 ms.
- Here we consider service requiring transit across both DOCSIS and WLAN.

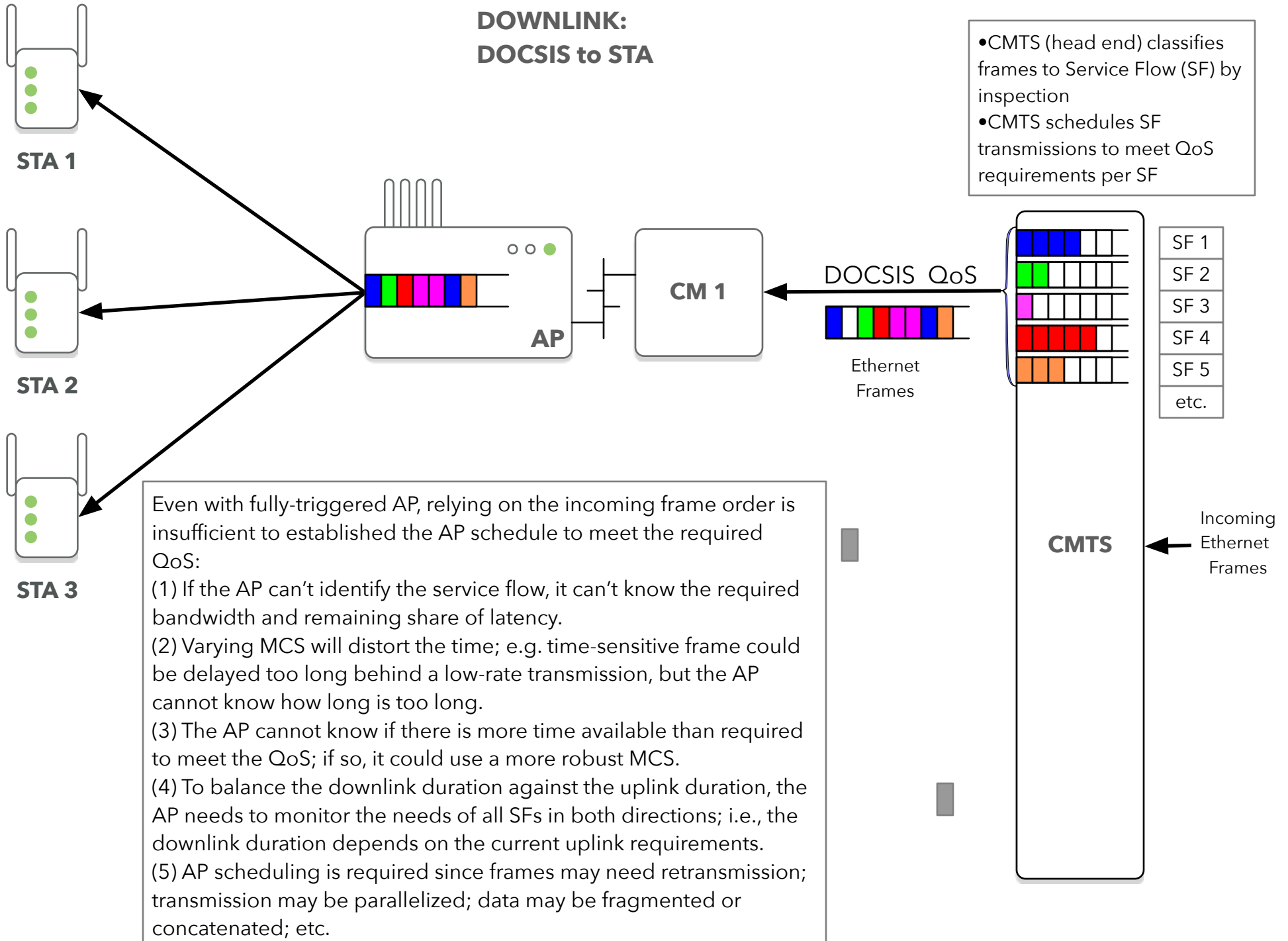

# DOWNLINK: WLAN Traffic Classes

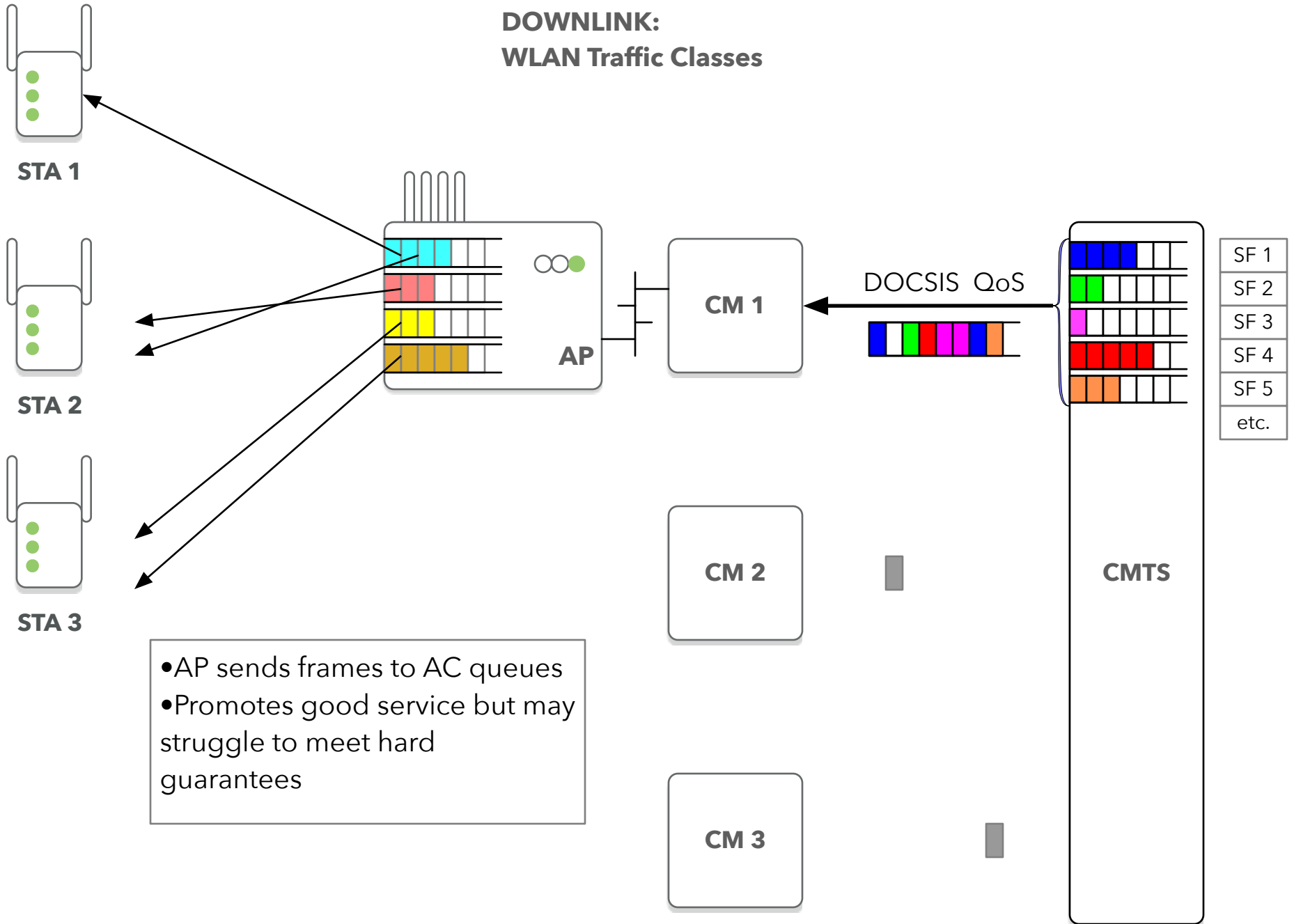



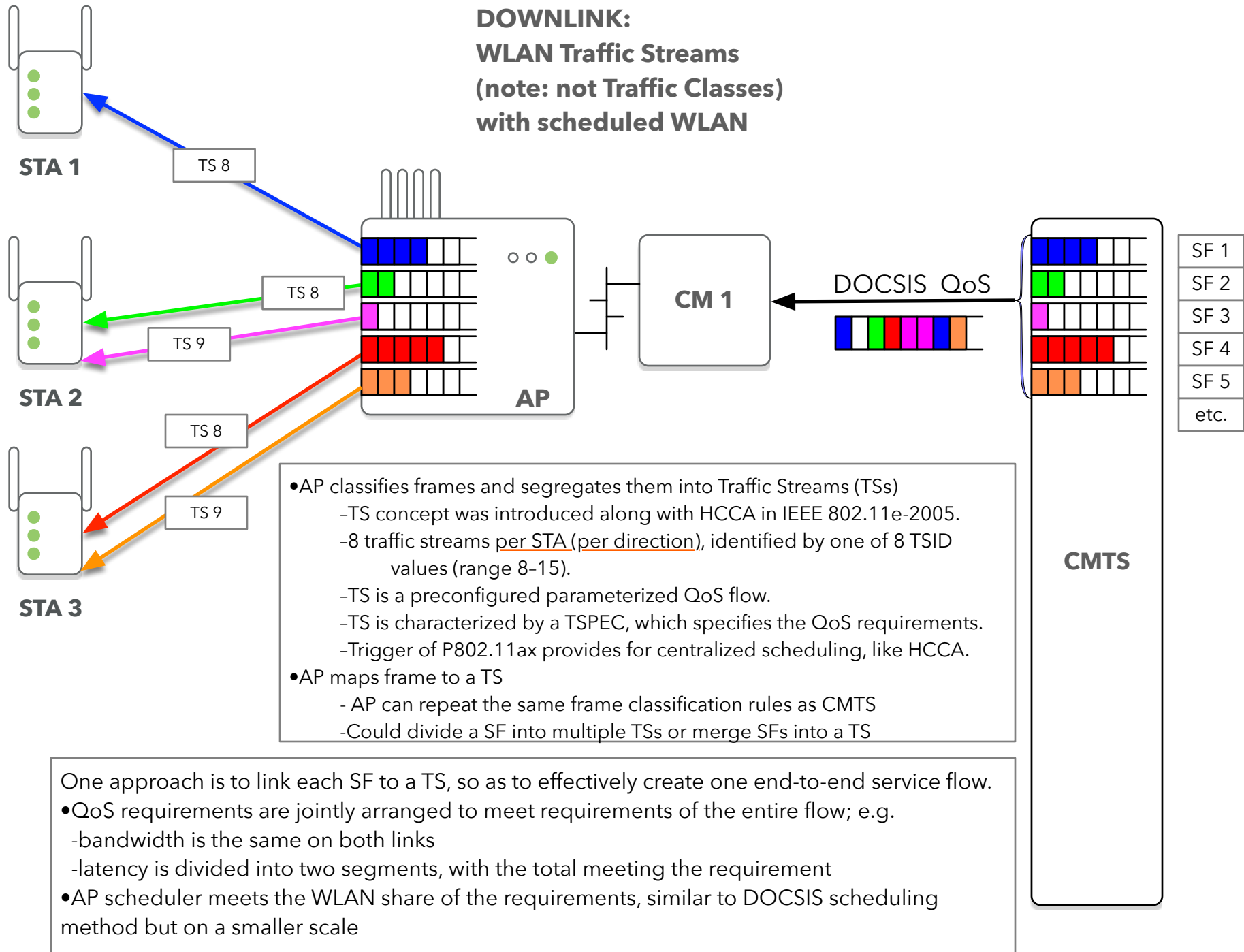

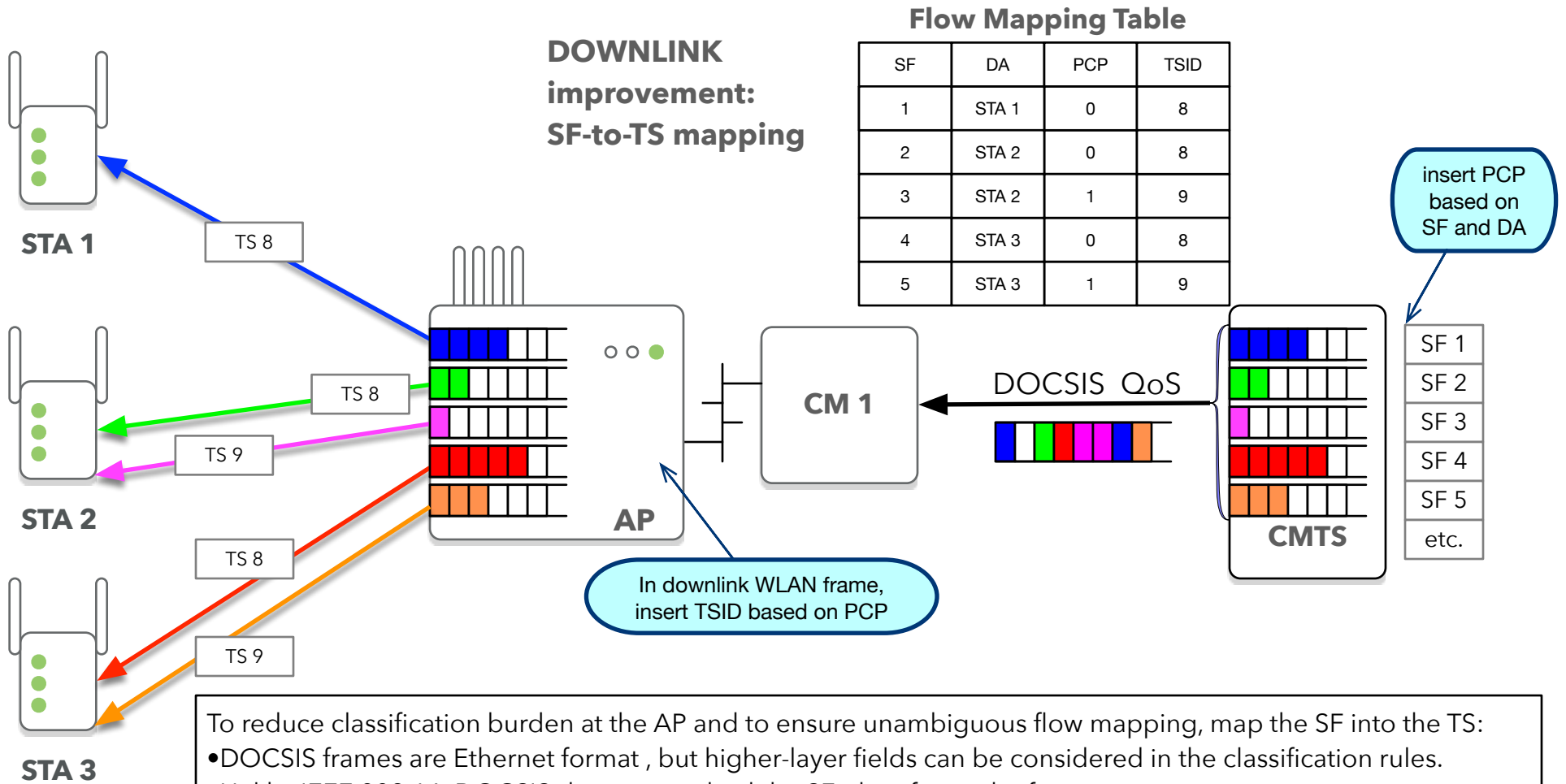

To reduce classification burden at the AP and to ensure unambiguous flow mapping, map the SF into the TS:

- DOCSIS frames are Ethernet format, but higher-layer fields can be considered in the classification rules.
- Unlike IEEE 802.16, DOCSIS does not embed the SF identifier in the frame
  - therefore, the AP and/or CMTS needs to work a little harder to find it
- Some possibilities:
  - A) The AP could repeat the full classification process enacted by the CMTS.
  - B) Presume that up to 8 SFs are assigned for delivery to a particular STA DA. Then the CMTS sets the frame priority code point (PCP) to identify the SF, for easy reading by the destination. The AP then encodes the PCP into the TSID field of the WLAN frame (e.g. TSID = PCP+8).
- During configuration, Traffic Streams and Service Flows are configured jointly and compatibly.

• Assigning >8 SFs to a STA, or bundling multiple TSs into an SF, may need additional information encoded by the CMTS, or other information in the frame, to allow the AP to select the TSID (see next slide).

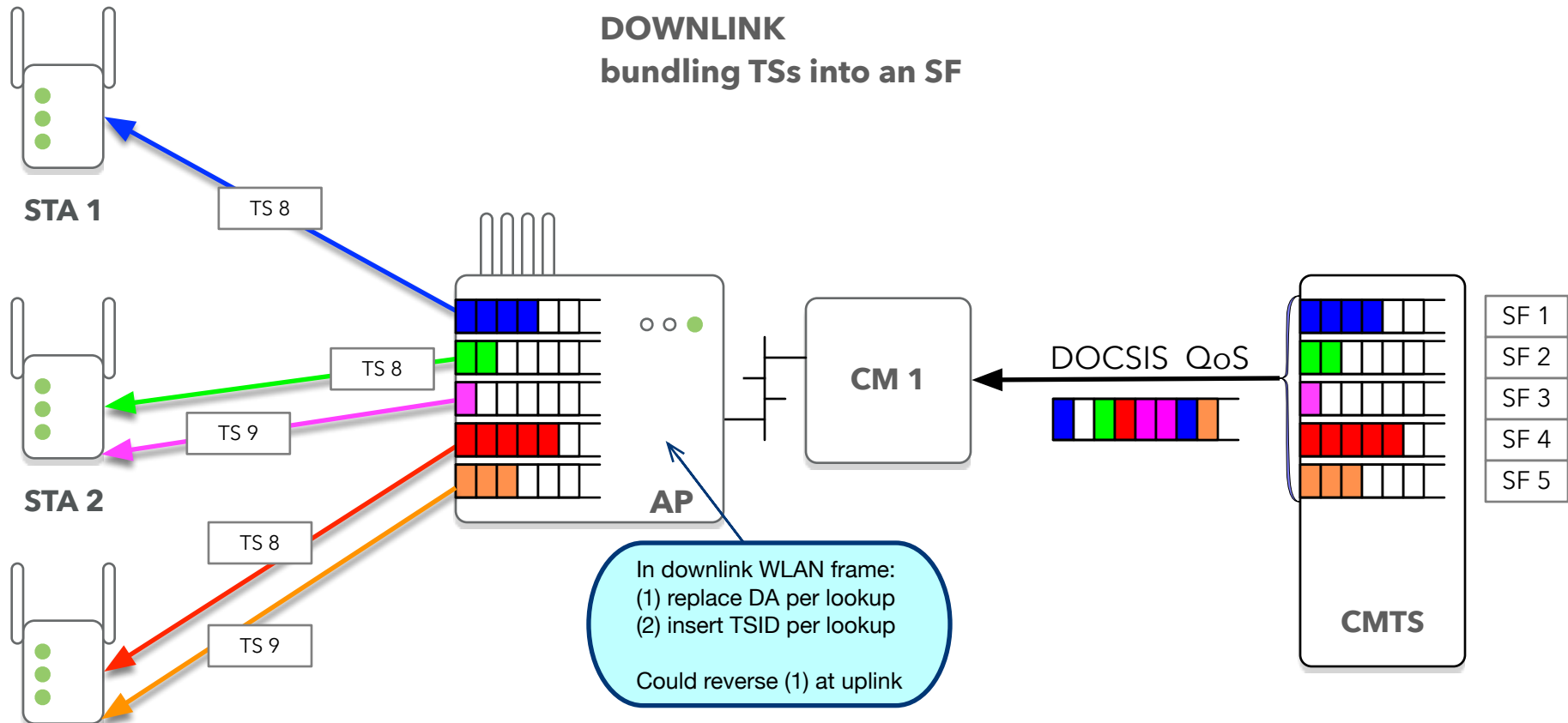

**Flow Mapping Table (example)**

DA (DOCSIS)	SF	DA (WLAN)	TSID
DA 1	1	STA 1	8
DA 2	1	STA 2	8
DA 3	1	STA 2	9
DA 4	1	STA 3	8
DA 5	1	STA 3	9

**Example: possible address format**

DA (DOCSIS) First 5 bytes	DA (DOCSIS) last byte	DA (WLAN)	TSID
ABCDE	0	STA 1	8
ABCDE	1	STA 2	8
ABCDE	2	STA 2	9
ABCDE	3	STA 3	8
ABCDE	4	STA 3	9

Could also separate by, e.g., VLAN, if VLAN tags are not used otherwise.

**DOWNLINK  
improvement:  
schedule sync**

For SF with pre-planned allocations, coordinate and synchronize AP scheduler with CMTS and CM. AP knows when frame will arrive and plans in advance to send it as soon as possible. May be able to operate with a smaller queue for improved latency.

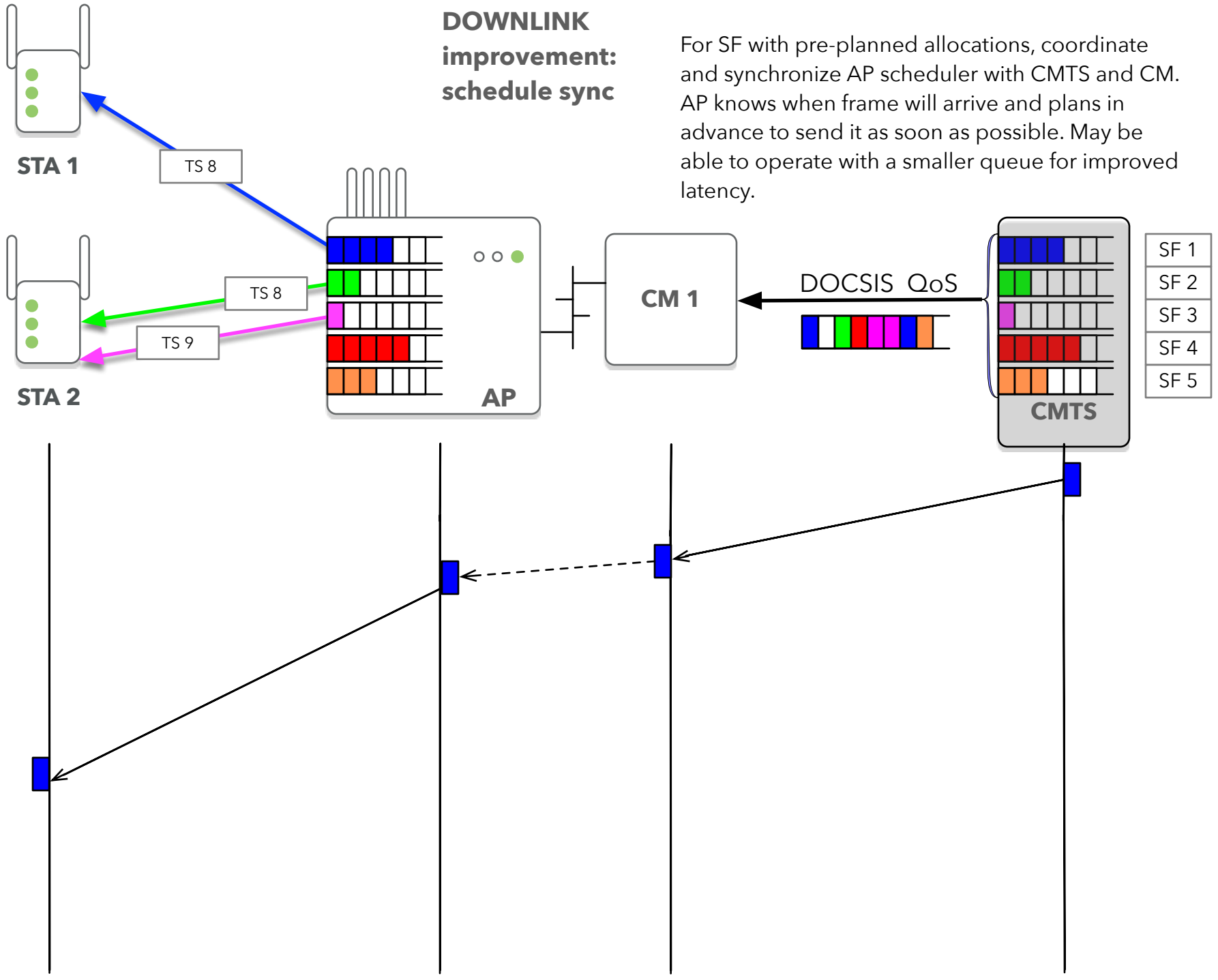

**UPLINK:  
STA to CMTS**

- CM classifies frames to Service Flow (SF) by inspection
- CM requests resources from CMTS
- CMTS grants resources, per SF and demand
- CM transmits per grants allocated

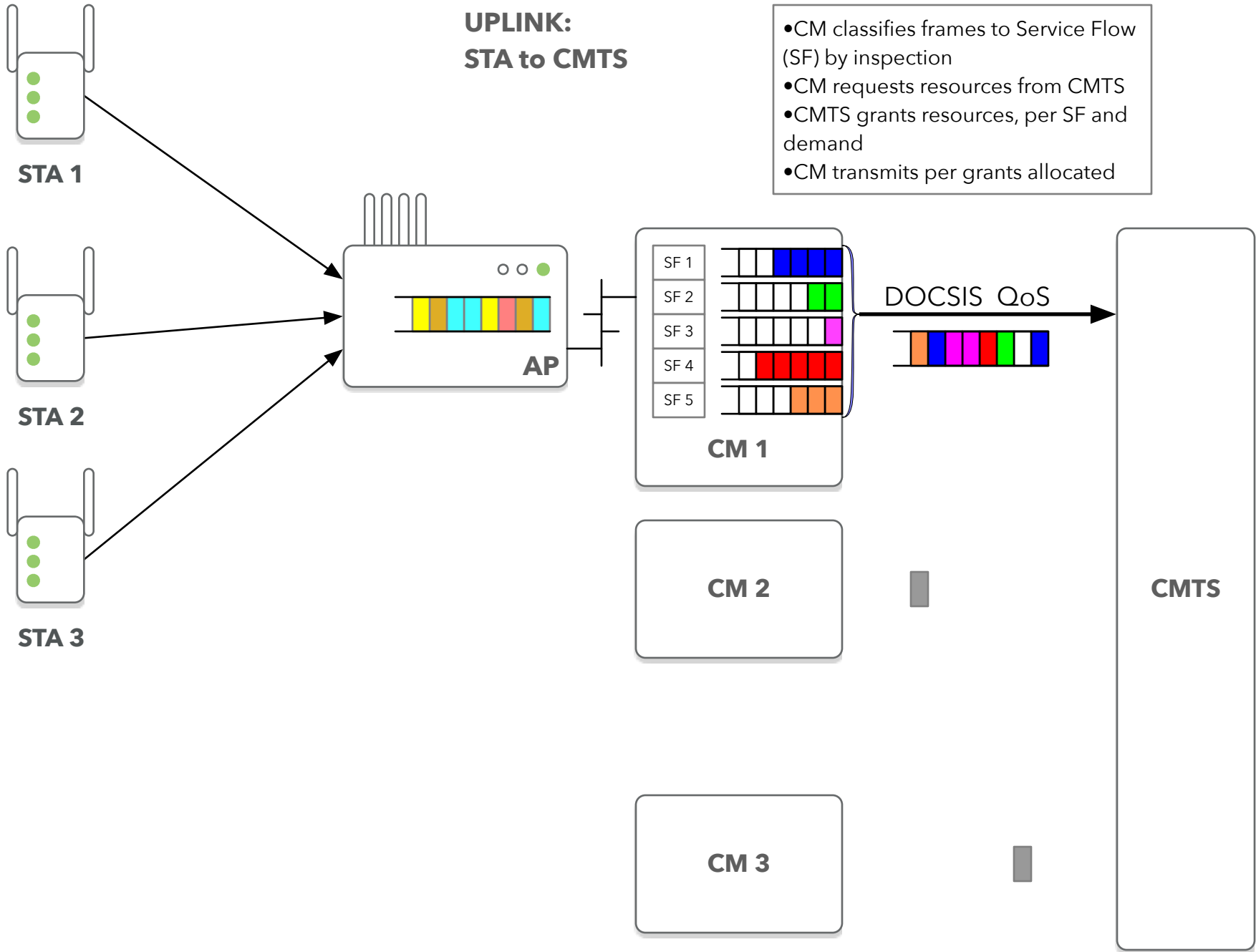

## UPLINK WLAN Traffic Classes

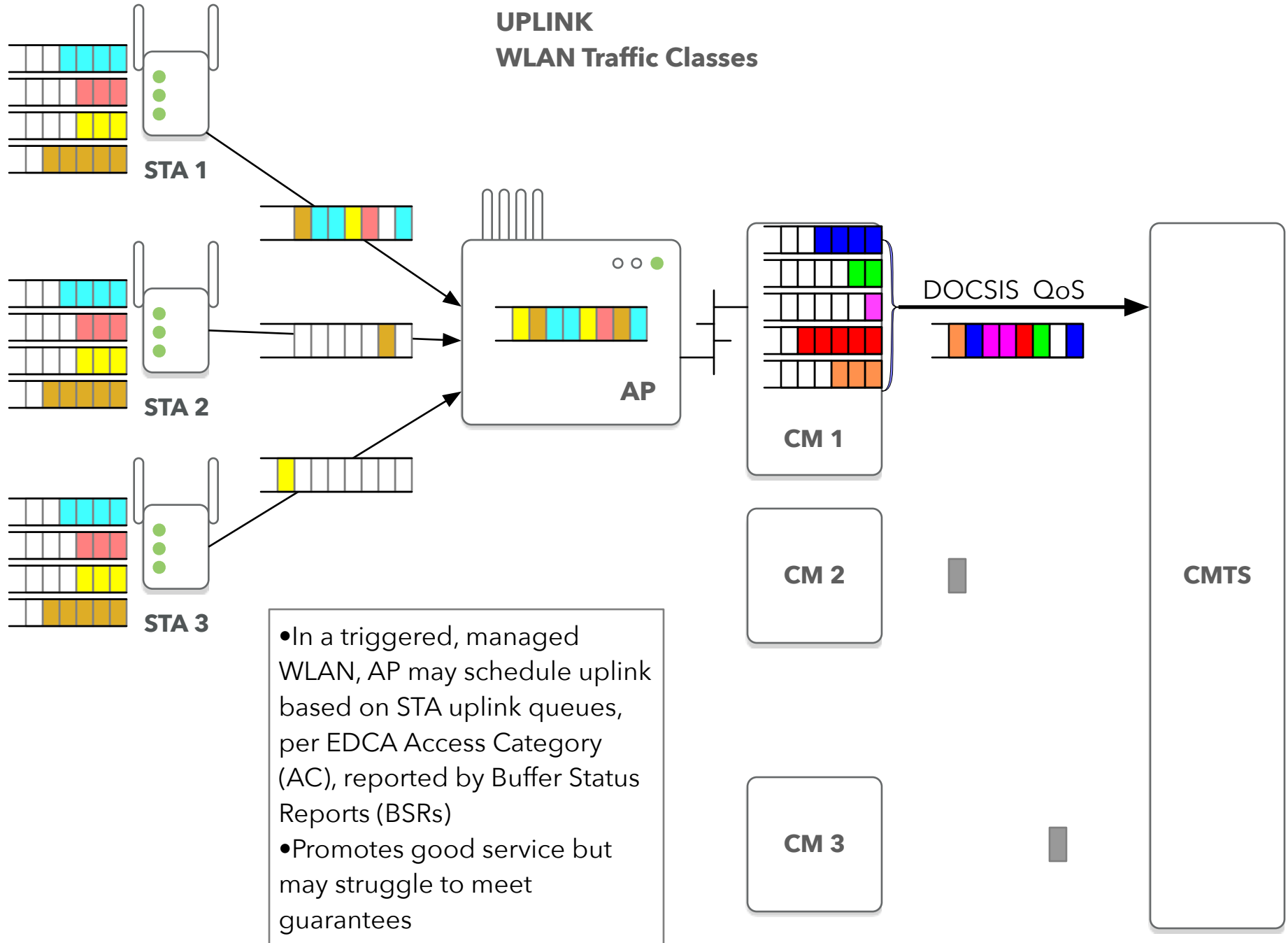

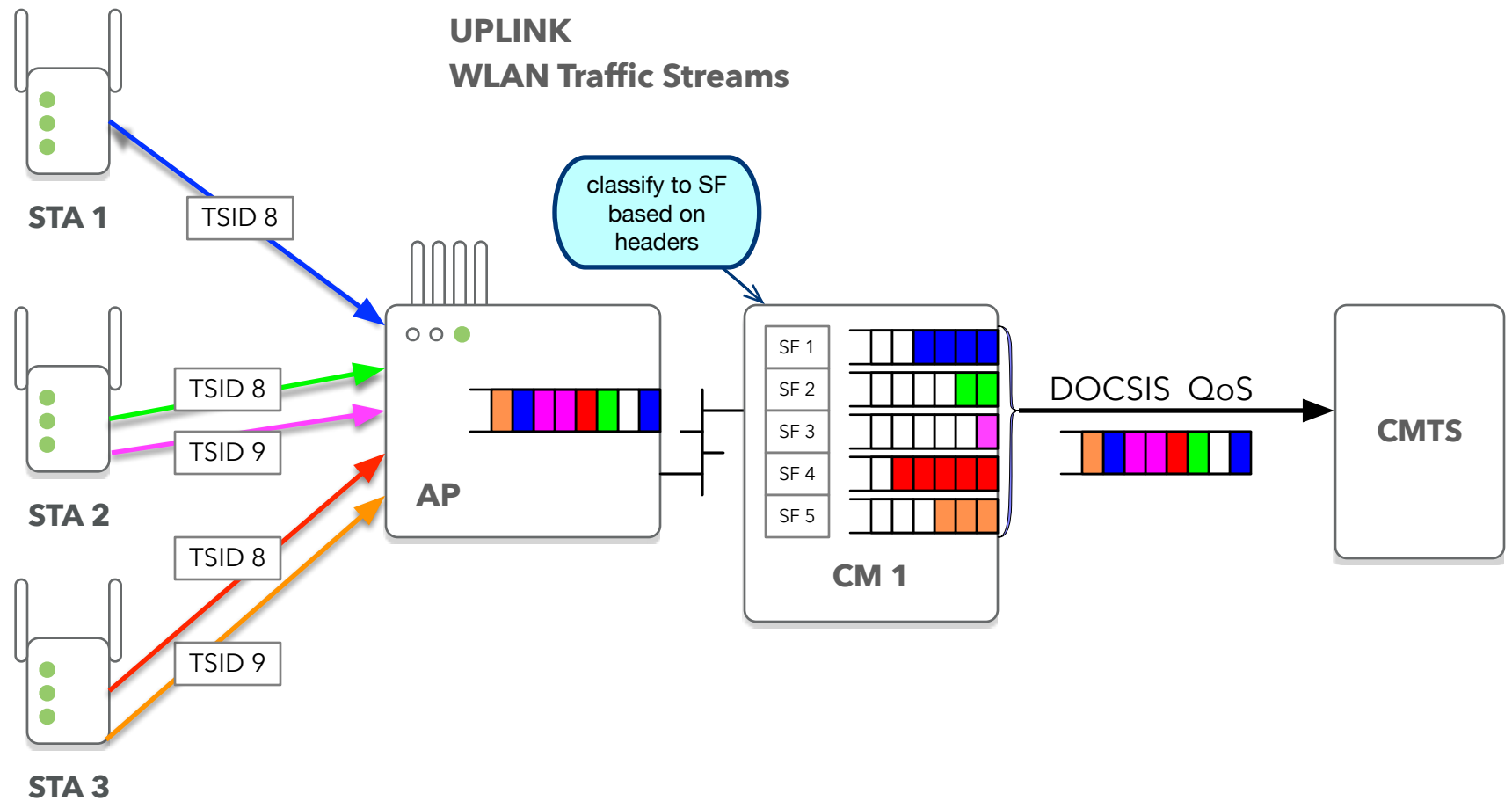

- Traffic streams represent preconfigured parameterized QoS flows
- Traffic streams are identified by one of 8 TSID values per STA

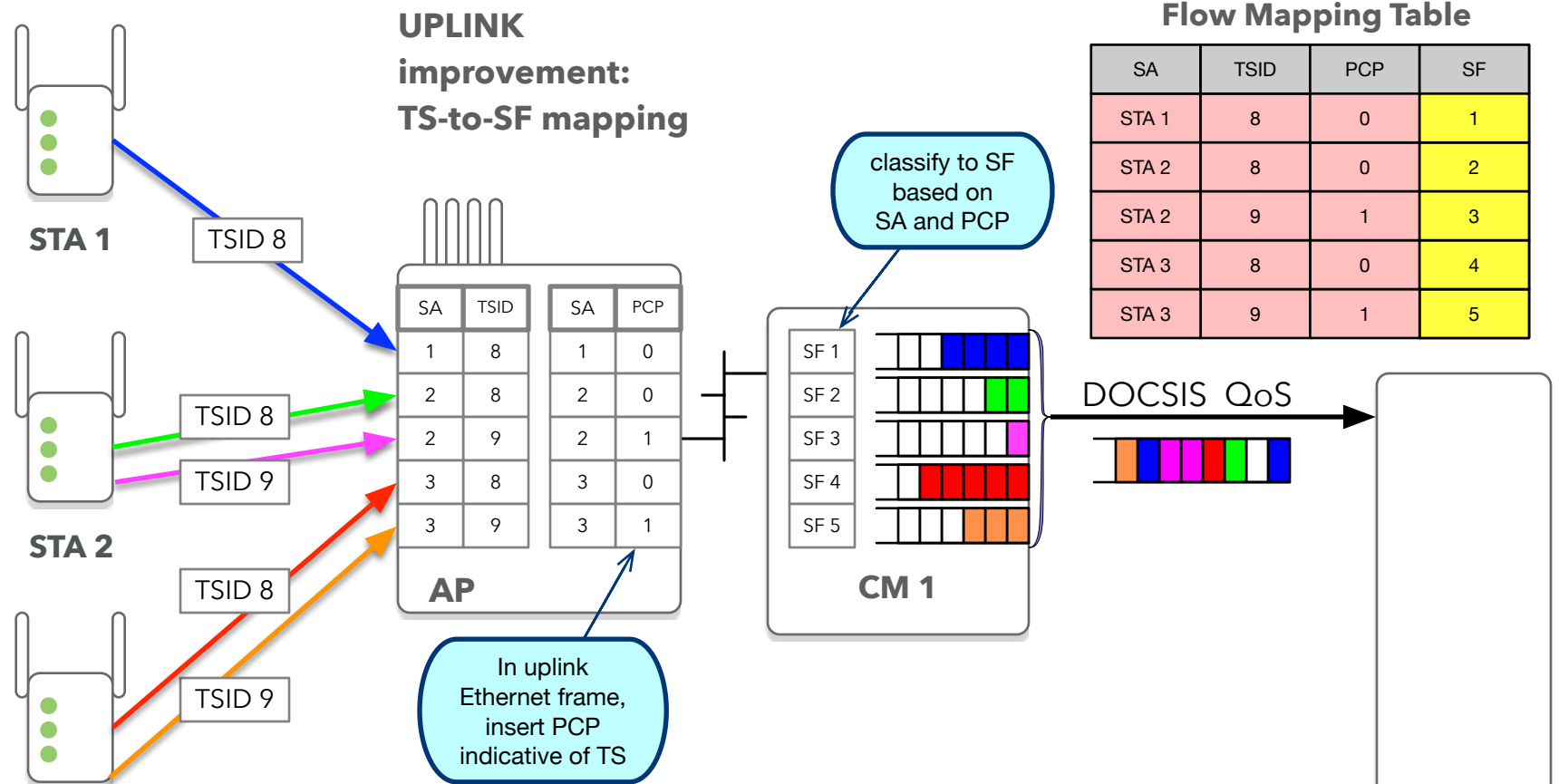

**STA 3**

- To reduce the classification burden at the CM and to ensure unambiguous flow mapping:
  - AP maps the Traffic Streams directly onto PCP (e.g., PCP=TPID-8)
  - CM maps the PCP directly onto Service Flow
- During configuration, Traffic Streams and Service Flows are configured jointly.
- The flow mapping table makes it simple to bundle multiple TSs into an SF
  - because CMTS may limit the number of SFs
  - no problem mixing TSs from different STAs
  - need to ensure that a TS does not cause undue interference with SF-mate.



**UPLINK  
improvement:  
coordinated pre-request**

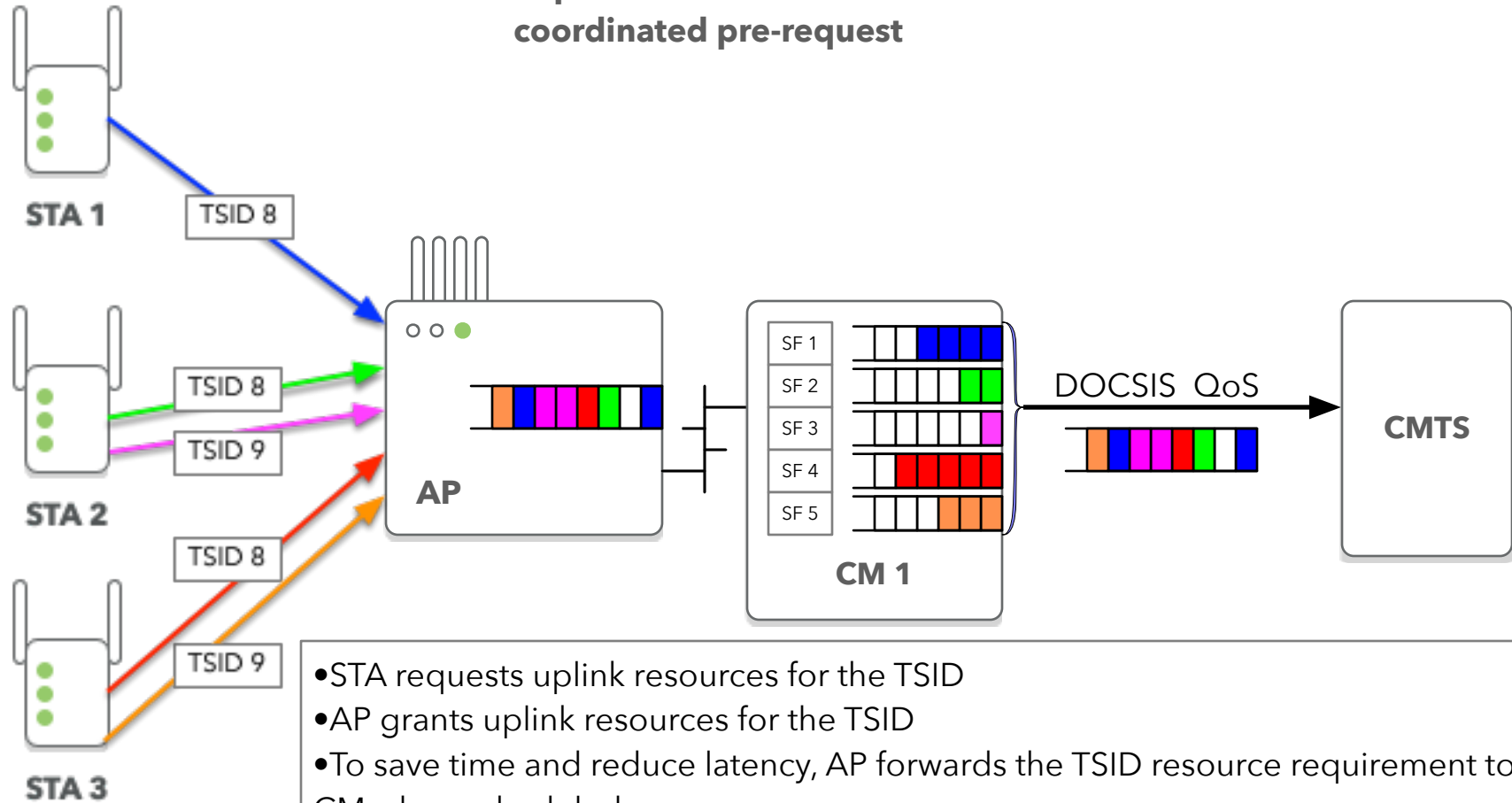

- STA requests uplink resources for the TSID
- AP grants uplink resources for the TSID
- To save time and reduce latency, AP forwards the TSID resource requirement to CM when scheduled.
- CM pre-requests the corresponding uplink resource for the corresponding SF.
  - This "pre-request" can be a conventional, standard request, but AP needs to ensure that it is not sent too early.
  - AP knows the exact WLAN grant time; needs to know the CMTS request/grant schedule.
  - Or a special pre-request format could specify a delay.

**UPLINK:**  
**request-grant process and timing**  
**(scheduled WLAN)**

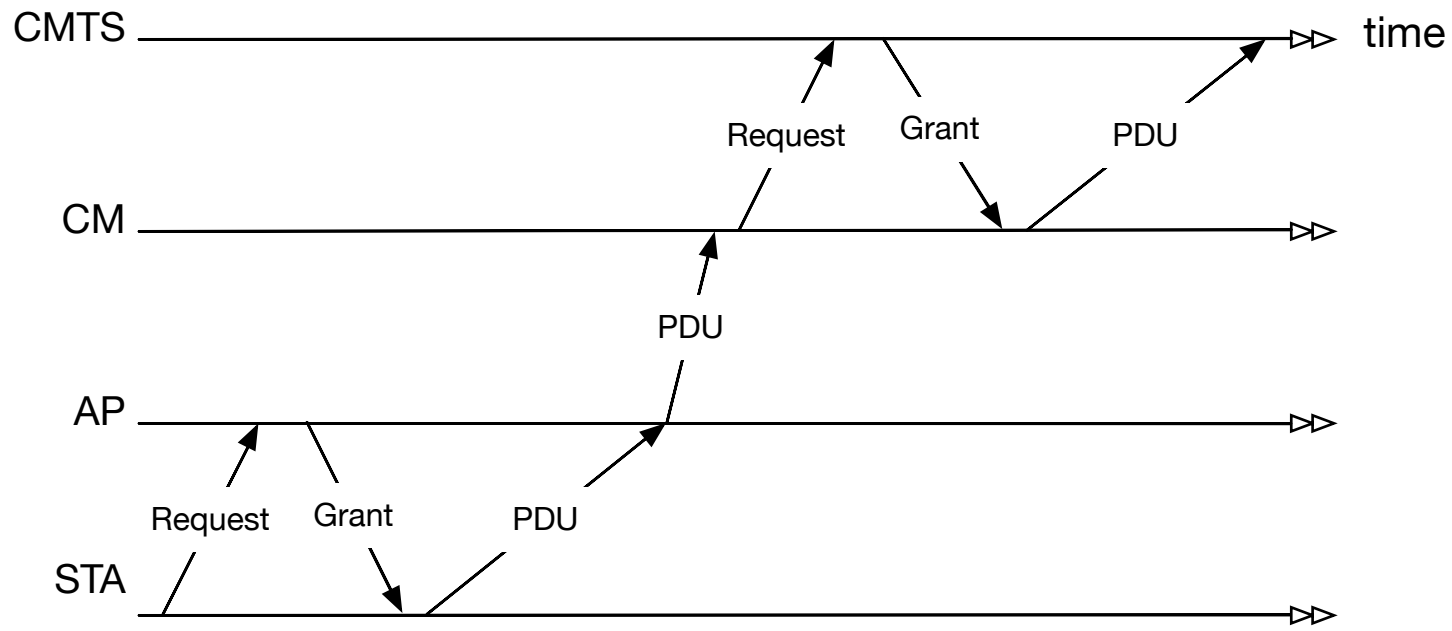

**conventional,  
without  
pre-request**

### UPLINK: coordinated pre-request timing

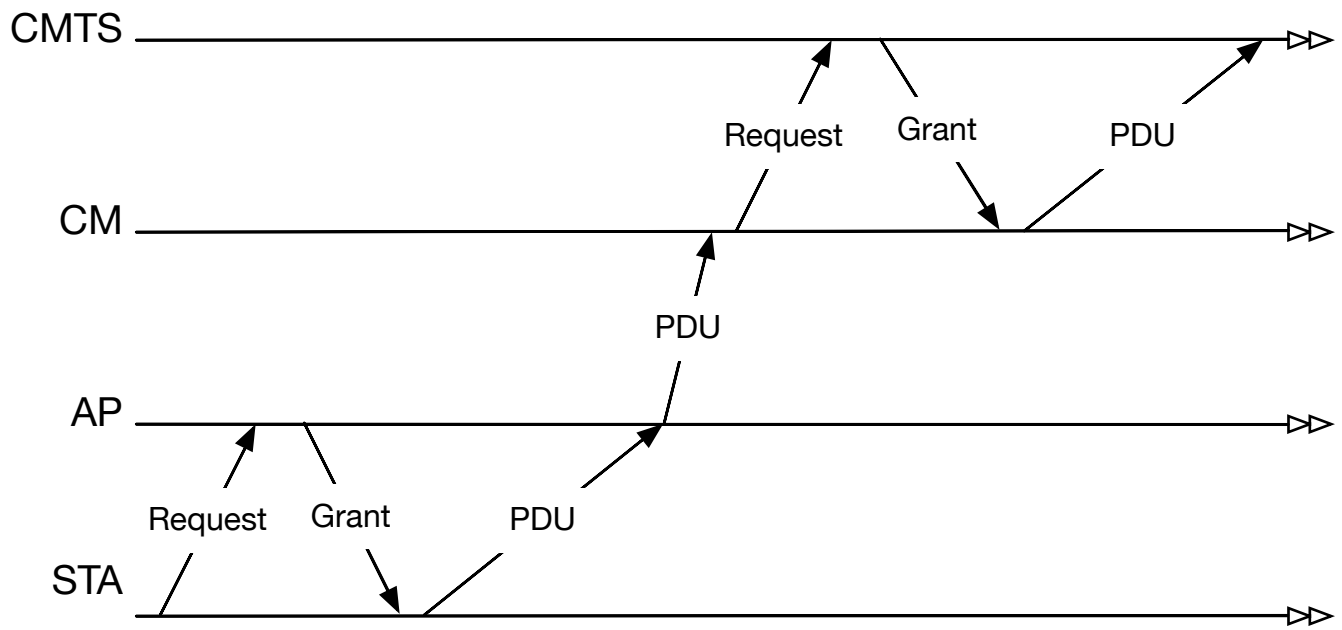

**conventional,  
without  
pre-request**

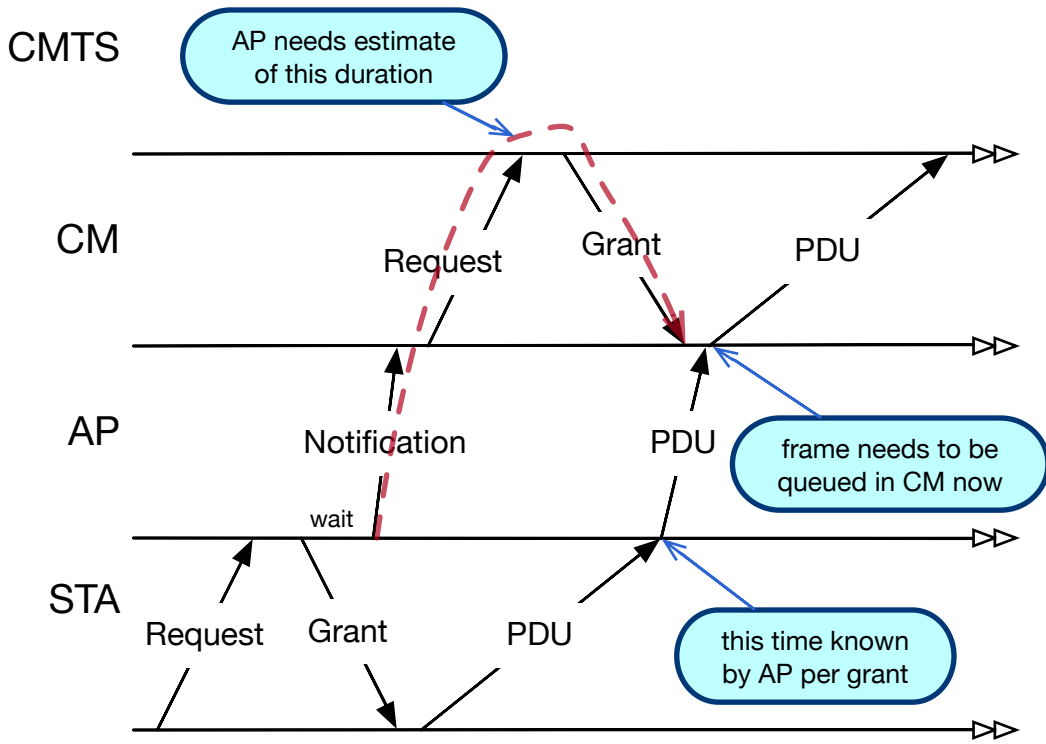

**coordinated  
pre-request**

# TSN stream mapping

BSS appears as TSN bridge

BSS is clock-synchronized to TSN network

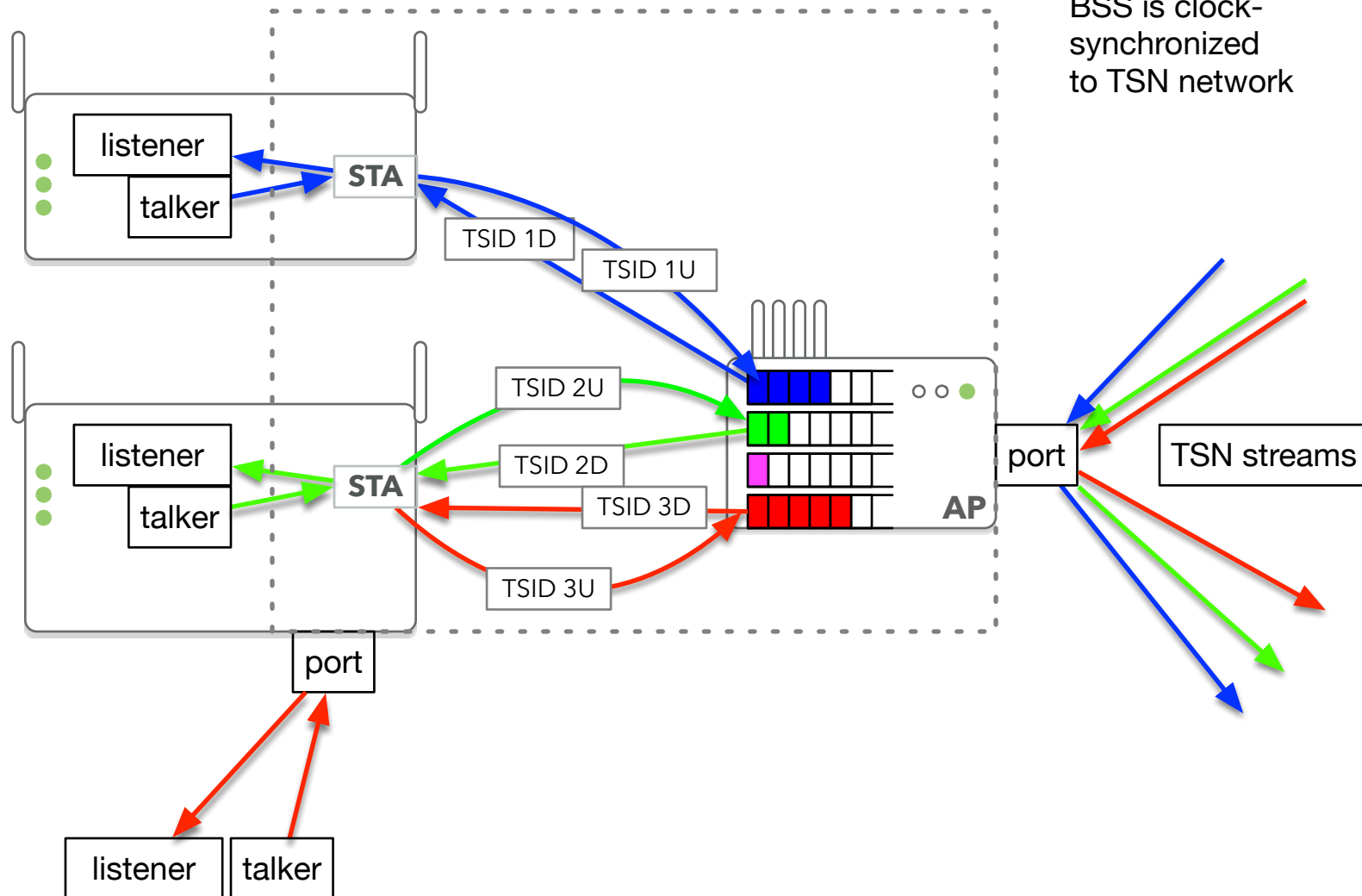

# IEEE 802 Nendica Report Development Process

- *Nendica work is organized as a set of semi-autonomous Work Items leading to Nendica Reports.*
- *Nendica will ensure that all Work Items are within Nendica scope and that they make progress.*
- *Nendica will ensure ongoing exposure and wide review by issuing Call for Comments on all drafts and completed reports.*
  
- **See:**
  - <https://1.ieee802.org/802-nendica/ieee-802-nendica-procedures/>

# IEEE 802 Nendica Work Item Initiation Process

- *Formal Work Item proposal*
  - *Demonstrate industry interest*
  - *Demonstrate fit with scope*
  - *Identify Editor*
- *With Nendica agreement, circulate for comment*
  - *Circulated to 802 EC and 802.1 Working Group thirty days before IEEE 802 Plenary*
  - *Circulated on Nendica web site*
- *Approval:*
  - *Nendica vote at face-to-face meeting*
  - *Subject to confirmation at 802.1 WG Plenary*
- *See:*
  - <https://1.ieee802.org/802-nendica/ieee-802-nendica-procedures/>

# Proposed Schedule

- Work Item initiation
  - 2020-01-15: present/discuss proposal at Nendica meeting
  - 2020-01-22/23: seek consensus at Nendica meeting
  - 2020-02-06?: finalize in telecon, if necessary
  - 2020-02-14: submit proposal to 802 & 802.1
  - 2020-03-19: agreed by 802.1 WG
- Draft development
  - Telecons
  - Meeting: 2020-05-19 to 21 (802.1 Pasadena); 2020-07-14 to 16 (802 Montreal)
- Call for Comments
  - Agree 2020-07-16 to initiate
  - Run 2020-07-24 through 2020-08-24
  - Comment resolution in telecons and 2020-09-22 to 24 (802.1 Stuttgart)
  - Recirculate; comment resolution in telecons and 2020-11-10 to 12 (802 Bangkok)
- Approval
  - 2020-11-19: IEEE 802.1 WG approval

# Fit to Nendica scope

- The proposal fits within the Nendica Scope.
- Nendica ICAID “Motivation and Goal” includes:
  - ...identify commonalities, gaps, and trends not currently addressed by IEEE 802 standards and projects, and facilitate building industry consensus towards proposals to initiate new standards development efforts. Encouraged topics include enhancements of IEEE 802 communication networks and vertical networks as well as enhanced cooperative functionality among existing IEEE standards in support of network integration...
- Nendica ICAID “Stakeholder Communities” includes:
  - ... users and producers of systems and components for networking systems, data center networks, high performance computing, cloud computing, telecommunications carriers, ...



# Tentative Outline

- List of Streams and Flows in various network standards
  - stream/flow characterization including:
    - Network architecture (e.g., point-to-point; point-to-multipoint)
    - Endpoints
    - Flow-sensitive elements (endpoints, bridges, etc.)
    - Flow identification (in-network and at endpoints)
    - Quantity of flows
    - Dynamic flow additions and changes
    - Packet classification method and rule setup
    - QoS capabilities
    - Request/grant system and polling services
- Uses for flow identification
- Interworking
  - Network combinations of practical interest
    - Feasibility of interworking
    - Value of interworking

# Tentative Proposal

- To initiate, within IEEE 802 Nendica, a new Work Item to develop an *IEEE 802 Nendica Report: Network Stream and Flow Interworking*
- Provide a catalog of the various streams and flows specified in IEEE 802 networks and other relevant networks.
- Considering a matrix of combinations of networks, discuss which combinations:
  - are relevant
  - could feasibly support flow interworking
  - would benefit from new interworking specifications
- Consider possibility of generic flow identification
- etc.

# References

- *Deterministic WLAN: A problem of scheduling and identifiers* (Roger Marks, Antonio de la Oliva, and Lukas Wuesteney, 2019-11-11)
  - <https://mentor.ieee.org/802.1/dcn/19/1-19-0079-00-ICne-deterministic-wlan-a-problem-of-scheduling-and-identifiers.pdf>
- IEEE 802 Nendica Procedures
  - <https://1.ieee802.org/802-nendica/ieee-802-nendica-procedures>
- IEEE 802 Nendica ICAID (March 2019 – March 2021)
  - <https://standards.ieee.org/content/dam/ieee-standards/standards/web/governance/iccom/IC17-001-IE.pdf>
- Nendica Document Server
  - [https://mentor.ieee.org/802.1/documents?is\\_group=ICne](https://mentor.ieee.org/802.1/documents?is_group=ICne)